

# Gigaset

DL500 A  
DX600 A ISDN  
DX800 A all in one

## Congratulations

By purchasing a Gigaset, you have chosen a brand that is fully committed to sustainability. This product's packaging is eco-friendly!

To learn more, visit [www.gigaset.com](http://www.gigaset.com).



GIGASET. INSPIRING CONVERSATION.  
**MADE IN GERMANY**



# Gigaset DX800A all in one, DX600A ISDN and DL500A – your perfect companion

---

... impressive interior and exterior qualities. Go crazy for the vibrant 3.5" TFT display, first-class sound quality and elegant exterior. Your Gigaset can do a lot more than just make calls:

## **Bluetooth, Ethernet, DECT and (device-specific) FAX port**

Connect your Gigaset to the Internet and your PC via Ethernet. Use public and private directories on the Internet ( → page 39). Update the directory on your Gigaset, the address book on your Bluetooth mobile phone and your directory on the PC simultaneously.

## **Directory with vCards – calendar and appointments**

Save phone numbers and other data to the local directory ( → page 38). Enter appointments and anniversaries in the calendar and set reminders.

## **Use your Gigaset as a PABX**

Register up to six handsets and use your Gigaset answering machine.

Using the Bluetooth interface, you can register up to five GSM mobile phones. You can connect one of the mobile phones with the base and make calls using this GSM connection – **Link2mobile**.

## **Go online with your Gigaset**

Use your phone's **Info Centre** and have information specifically provided for the phone from the Internet shown on the display.

## **Do not disturb**

Switch off the display backlight at night ( → page 49), use time control for calls ( → page 50) or reject unknown calls ( → page 50).

## **Other practical information**

Transfer the directory from an existing Gigaset handset ( → page 38), use the programmable function keys ( → page 48) for speed dial and quick access to important functions, use the convenient headset to make calls, read your e-mail messages (without a PC) on your phone.

## **It's easy to configure your Gigaset DX800A all in one/DX600A ISDN thanks to the wizards**

These determine the MSNs for your ISDN connection and general VoIP provider data (provider-specific) and assist you with registering handsets and assigning send and receive connections to the base, handsets, fax machine and integrated answering machine ( → page 16).

## **Environment**

Gigaset Green Home – be environmentally aware when using your phone. For details of our ECO DECT products, visit [www.gigaset.com/service](http://www.gigaset.com/service)

## User guide

This document only describes how to get started with your Gigaset phone and its key functions in condensed form.

There is a detailed description of the phone and its functions and a description of its Web configurator on the enclosed CD. You can make phone settings from the PC via the Web configurator (the phone's Web interface).

These instructions are in PDF format. You will need Adobe® Reader® to view these documents. You can also find Adobe® Reader® on the CD or on the Internet at [www.adobe.com](http://www.adobe.com).

Further information about your phone can be found at:

[www.gigaset.com/gigasetDX800A](http://www.gigaset.com/gigasetDX800A) (Gigaset DX800A all in one)

[www.gigaset.com/gigasetDX600A](http://www.gigaset.com/gigasetDX600A) (Gigaset DX600A ISDN)







[www.gigaset.com/gigasetDL500A](http://www.gigaset.com/gigasetDL500A) (Gigaset DL500A)

**After purchasing your Gigaset phone, please register it at [www.gigaset.com/service](http://www.gigaset.com/service) – this will ensure any questions you may have or warranty services you request are dealt with even faster!**

**Have fun using your new phone!**

## Please note

**To change the display language, proceed as follows:**

- ▶ Press right on the control key .
- ▶ Press the following keys in sequence:     .
- ▶ Press up/down on the control key  until the correct language is selected. Then press the right display key.

## Gigaset service contact numbers:

For personal advice on our range of products and for repairs or guarantee/warranty claims call:

**Service Centre UK: 08453 6708 12**

(local call cost charge)

Please have your proof of purchase ready when calling.

# Base overview

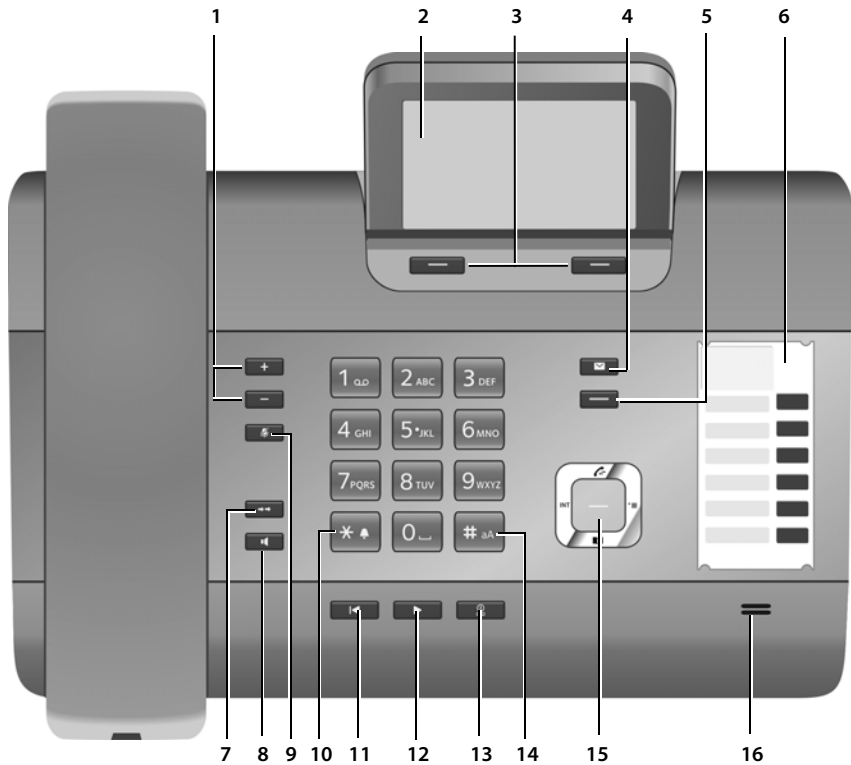

- 1 **Adjust volume** = quieter; = louder  
 During a call/message playback:  
 Handsfree/receiver volume;  
 When an external call is being signalled:  
 Ringer volume
- 2 **Display**
- 3 **Display keys** (programmable; page 48)  
 In the menu: Open a menu for further functions
- 4 **Message key** (page 37)  
 Access to call and message lists;  
 Flashes: New message/call or new firmware/new provider profile available
- 5 **End/cancel key** (red key)  
 End call, cancel function, go back one menu level (press briefly), back to idle status (press and hold)
- 6 **Function keys** (programmable; page 48)
- 7 **Redial**  
 Open redial list (page 37)
- 8 **Handsfree key**
- 9 **Mute key**  
 During a call: Activate/deactivate microphone
- 10 **\* key**  
 Activate/deactivate ringer (press and hold);  
 Text input: Special characters table
- 11 **Back key** for answering machine  
 During playback: Back to the start of the message/previous message
- 12 **Playing back messages**  
 Activate/deactivate message playback
- 13 **On/off key** for answering machine  
 Activate/deactivate answering machine (page 42)
- 14 **# key**  
 For text input: Switch between upper/lower case letters and digits
- 15 **Control key**
- 16 **Microphone**

# Display icons

## Display in idle status (example)

Base status (two lines)	02 02	06:30	
Current month/year	Mar 2010	M T W T F S S	Appointment entered
Time	13:52	0 0 1 1 1 1 1	in calendar
Internal name	INT 1	1 1 1 1 2 2 2	Current date
		2 2 2 2 2 2 2	
		2 3	
	Calls	Calendar	

**Status display in the headers:** The following icons are displayed dependent on the settings and the operating status of your base:

- Answering machine icon
- DX600A/DX800A:** 1/2/3 numbers of the activated answering machines (orange=on)
- DL500A:** 1 (orange) answering machine activated
- Eco Mode+ activated (white), Eco Mode+ and Eco Mode activated (green)
- Bluetooth activated; Bluetooth headset connected;
- Bluetooth GSM mobile phone connected
- Ringer deactivated (page 50)  
Replaced by when alert tone activated
- Alarm switched on and wake-up time set
- Number of new messages:
  - In the missed alarms list
  - In the SMS list (page 41) or e-mail list
  - In the missed call list (page 37)
  - On the network mailbox

## Signalling

External call

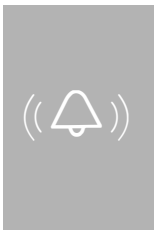

Internal call



Answering machine is recording



Alarm clock

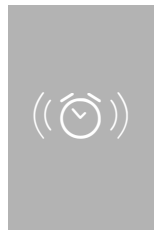

Appointment/anniversary



# Contents

---

<b>Gigaset DX800A all in one, DX600A ISDN and DL500A – your perfect companion</b> .....	<b>1</b>
<b>Base overview</b> .....	<b>3</b>
<b>Display icons</b> .....	<b>4</b>
<b>Safety precautions</b> .....	<b>7</b>
<b>First steps</b> .....	<b>8</b>
Checking the package contents .....	8
Setting up the base .....	9
Connecting the base .....	10
Gigaset DX600A ISDN, DX800A all in one: Setting up the base – installation wizard .....	16
Date/time .....	32
Guide .....	34
<b>Making calls</b> .....	<b>35</b>
Making an external call .....	35
Making an internal call .....	35
Ending a call .....	35
Accepting a call .....	35
Activating/deactivating handsfree/open listening mode .....	36
Muting the base .....	36
Making calls using network services .....	36
<b>Using lists</b> .....	<b>37</b>
Redial list .....	37
Call lists .....	37
Opening lists with the message key .....	37
<b>Using directories</b> .....	<b>38</b>
Using the local base directory .....	38
Using online telephone directories .....	39
Using the private net directory .....	39
Using the Gigaset.net directory (Gigaset DX800A) .....	40
<b>Sending SMS (text messages)</b> .....	<b>41</b>
Writing/sending SMS .....	41
Receiving an SMS .....	41
Reading SMS, managing lists .....	41
<b>Operating the base answering machine</b> .....	<b>42</b>
Operating via the base .....	42
Activating/deactivating call screening .....	44
Operating when on the move (remote operation) .....	44

# Contents

<b>Registering Bluetooth devices</b> .....	<b>46</b>
Using a Bluetooth headset .....	46
Using GSM mobile phones – Link2mobile .....	47
<b>Setting up the base</b> .....	<b>48</b>
Accessing functions and numbers quickly .....	48
Setting the display .....	48
Changing the handsfree/receiver volume .....	49
Setting ringers .....	50
Activating/deactivating advisory tones .....	51
Changing the system PIN .....	51
Setting your own area code .....	51
<b>Customer Service &amp; Assistance</b> .....	<b>52</b>
Questions and answers .....	53
Authorisation .....	53
<b>Menu overview Gigaset DX800A all in one</b> .....	<b>54</b>
<b>Menu overview Gigaset DX600A ISDN</b> .....	<b>59</b>
<b>Menu overview Gigaset DL500A</b> .....	<b>63</b>
<b>Index</b> .....	<b>66</b>
<b>Insert strip – labelling function keys</b> .....	<b>69</b>



# Safety precautions

---

## Warning

Be sure to read this user guide and the safety precautions before using your telephone.

Explain their content and the potential hazards associated with using the telephone to your children.



Use only the power adapter supplied, as indicated on the underside of the base.

Use only the cables supplied for fax, fixed line, ISDN, LAN and receiver connection and connect these to the intended port only.



Using your telephone may affect nearby medical equipment. Be aware of the technical conditions in your particular environment e.g., doctor's surgery.



Do not install the phone in a bathroom or shower room. The phone is not splash-proof.



Do not use your phone in environments with a potential explosion hazard (e.g., paint shops).



If you give your phone to a third party, make sure you also give them the user guide.



Remove faulty telephones from use or have them repaired by our Service team, as they could interfere with other wireless services.

## Please note

- ◆ Please note that only terminals that are operated in-house (inside buildings) may be connected to the analogue TAE/ISDN connections.
- ◆ Not all functions described in this user guide are available in all countries and with all providers.

# First steps

## Checking the package contents

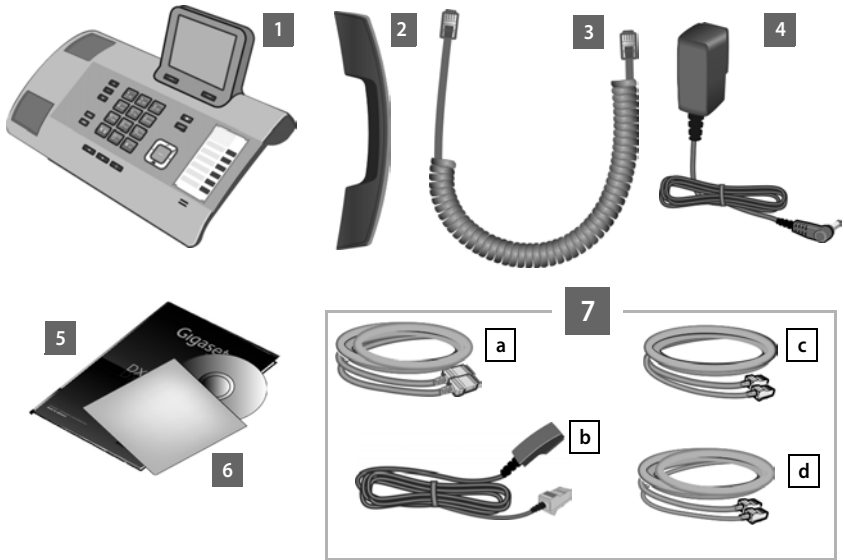



- 1 One base
- 2 One receiver to be connected to the base
- 3 One (coiled) cable for connecting the handset to the base
- 4 One power cable for connecting the base to the mains power supply
- 5 This quick guide
- 6 One CD
- 7 Various connection cables (device-specific):



**Gigaset DX800A all in one:**

- One Ethernet (LAN) cable **a** (Cat 5 with 2 RJ45 modular jacks) for connecting to a router (LAN/Internet) or PC
- One phone cable **b** for connecting to the analogue fixed line (TAE RJ45 8 pin; the outer 2 pins are in use, cable slightly flattened)
- One phone cable **c** for connecting to the ISDN (8 pin with 2 mini western jacks 8/8; the inner 4 pins are in use, cable slightly flattened)
- One cable **d** for connecting a fax device to the base (6 pin with 2 mini western jacks 6/6)

**Gigaset DX600A ISDN:**

- One Ethernet (LAN) cable  (Cat 5 with 2 RJ45 modular jacks) for connecting to a router (LAN/Internet) or PC
- One phone cable  for connecting to the ISDN (8 pin with 2 mini western jacks 8/8; the inner 4 pins are in use, cable slightly flattened)
- One cable  for connecting a fax device to the base (6 pin with 2 mini western jacks 6/6)

**Gigaset DL500A:**

- One Ethernet (LAN) cable  (Cat 5 with 2 RJ45 modular jacks) for connecting to a router (LAN/Internet) or PC
- One phone cable  for connecting to the analogue fixed line (TAE RJ11 6 pin)

**Firmware updates**

This user guide describes the functions of your base from firmware version 56.00.

Whenever there are new or improved functions for your Gigaset, firmware updates are made available for you to download to your base. If this results in operational changes when using your base, a new version of this user guide or the necessary amendments will be published on the Internet at

[www.gigaset.com](http://www.gigaset.com).

Select the product to open the relevant product page for your base, where you will find a link to the user guide.

## Setting up the base

The base is designed for use in dry rooms in a temperature range of +5°C to +45°C.

- ▶ Set up the base at a central point in the building.

**Please note**

If you wish to operate handsets from the base, consider the range of the base. This is up to 300 m in unobstructed outdoor areas and up to 50 m inside buildings. The range is reduced when **Eco Mode** is activated.

The phone's feet do not usually leave any marks on surfaces. However, due to the multitude of different varnishes and polishes used on today's furnishings, the occurrence of marks on the surfaces cannot be completely ruled out.

**Warning**

- ◆ Never expose the telephone to any of the following: Heat sources, direct sunlight or other electrical appliances.
- ◆ Protect your Gigaset from moisture, dust, corrosive liquids and fumes.

## Connecting the base

The following diagram is an overview of all connections for your base. The individual connections are described in detail below.

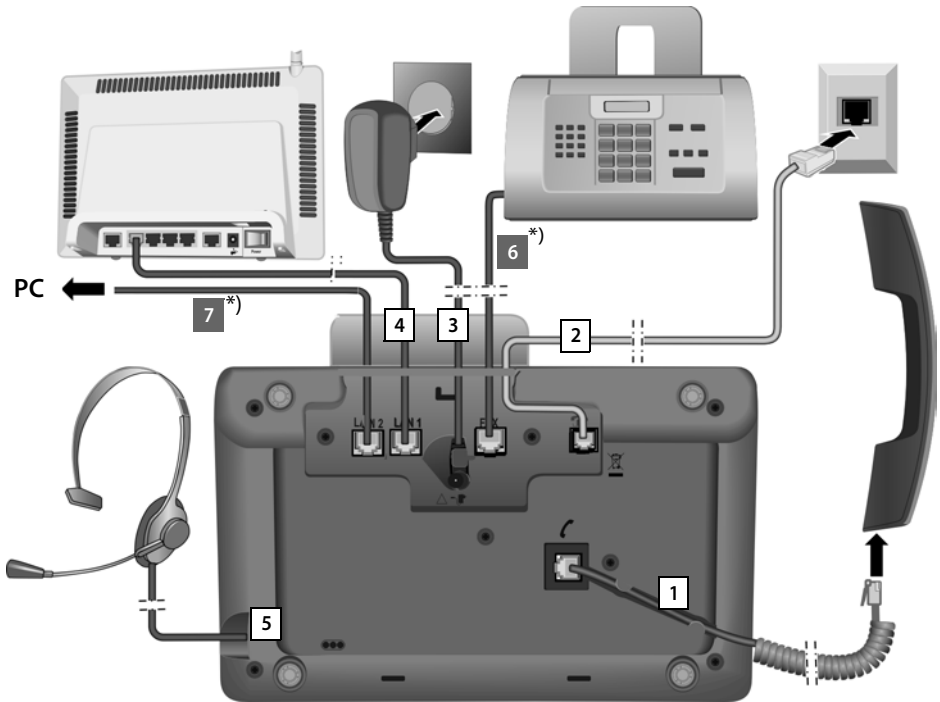

Follow the steps in the order given below:

- 1 Connect the receiver to the base.
  - 2 Connect the base to the telephone network.
  - 3 Connect the base to the mains power supply.
  - 4 Connect the base to the router for accessing the Internet (connection via router and modem or via router with integrated modem) and for configuring the base via the Web configurator.
  - 5 Connect a wire-bound headset to the base.
- \*) Additional device-specific connections:
- 6 **Gigaset DX600A ISDN/DX800A all in one:**  
Connect the base to a fax device.
  - 7 **Gigaset DX800A all in one:** You can connect a PC to the base via the second LAN socket LAN2 (optional) – e.g., to connect the PC to the router. The base takes on the task of a switch.

## 1. Connecting the receiver to the base

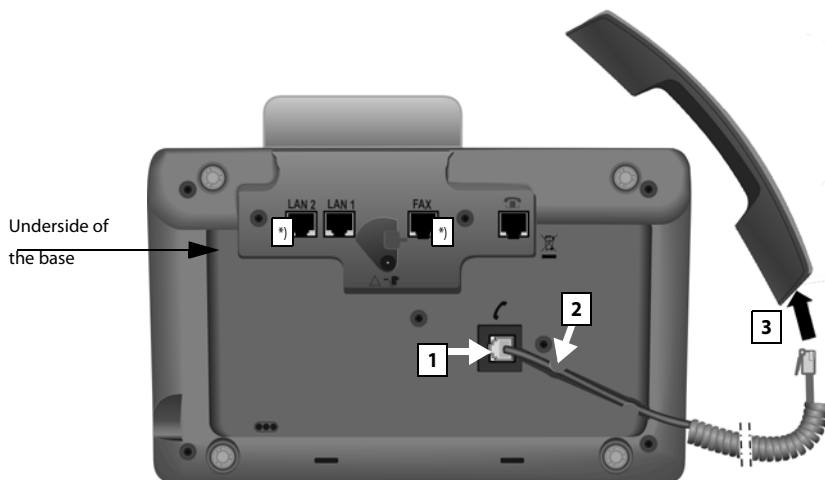

\*) The LAN2 and FAX connections are not available for all devices

- 1 Insert the jack, which can be found on the longer straight end of the connection cable, into the connection port marked with the symbol  on the underside of the base.
- 2 Place the straight part of the cable in the cable recess provided.
- 3 Insert the other jack on the connection cable into the port on the receiver.

## 2. Connecting the base to the telephone network

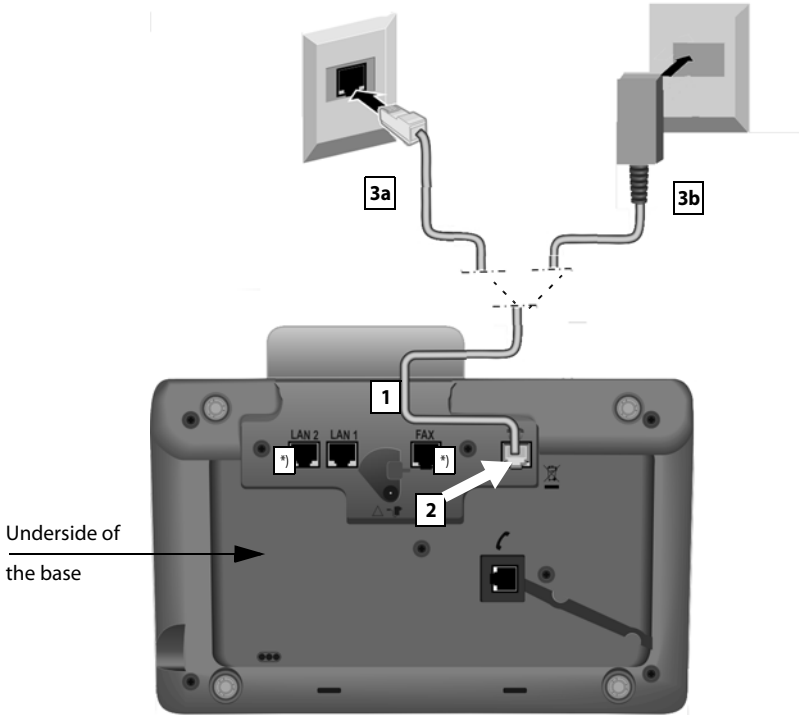

\*) The LAN2 and FAX connections are not available for all devices ( → page 10)

- 1 Insert one end of the phone cable ( → page 8) from the rear into the recess in the housing.

### Gigaset DX800A all-in-one:

- Use the 8 pin cable with 2 mini western jacks 8/8 if you want to connect the phone to the ISDN network ( → page 8, cable 7c).
- Use the TAE connection cable with RJ11 jack to connect to the analogue fixed line ( → page 8, cable 7b).

**Your telephone automatically detects which line it is connected to. The installation wizard will later prompt you to make the necessary settings for the current connection ( → page 16).**

- 2 Plug the telephone cable into the port marked with the symbol  on the underside of the base.
- 3 Then connect the phone cable to your phone connection (3a ISDN or 3b analogue fixed line).

### 3. Connecting the base to the mains power supply

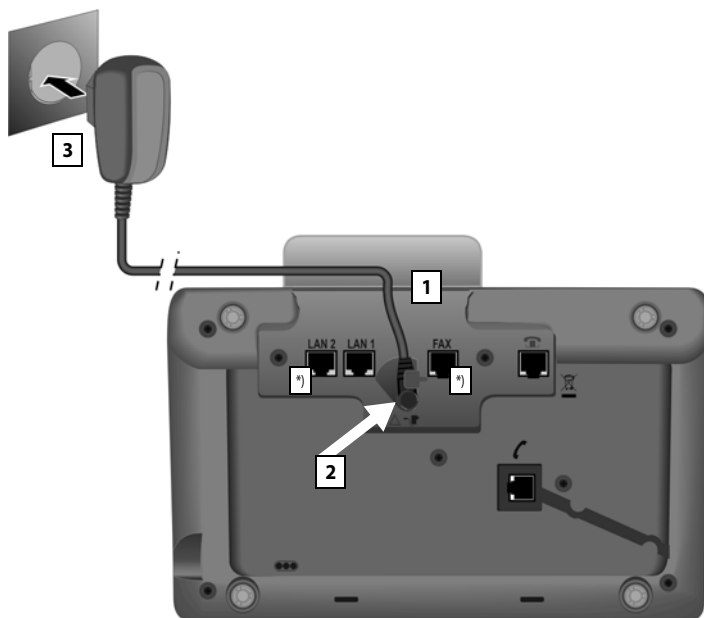

\*) The LAN2 and FAX connections are not available for all devices ( → page 10)

- 1 Insert the small jack on the power cable from the rear into the recess in the housing.
- 2 Plug the jack into the port marked with the symbol  on the underside of the base.
- 3 **Then** connect the power cable to the mains power supply.

#### Warning

- ◆ Keep the power cable **plugged in at all times** for operation, as the base does not work without a mains connection.
- ◆ Use only the power and telephone cables **supplied**.

Gigaset DX800A all in one, DL500A:

The **pin connections** of telephone cables for the analogue fixed line can vary. The correct pin connections can be found in the long user guide on the enclosed CD.

The software of the base is loaded. After a short time, the idle display is displayed on the base; it is in idle mode.

**Now you can make calls with your base via the fixed line or ISDN, and can be reached via your fixed line number or the main number of your ISDN connection! The answering machine on the base is set with a pre-recorded announcement in answer and record mode ( → page 42).**

#### 4. Connecting the base with a router (Internet) or PC

For the **Gigaset DX800A all in one**, the connection to a router is mainly needed for the Internet telephony VoIP (Voice over Internet Protocol). You can set up and configure up to six accounts (VoIP phone numbers) from one or several VoIP provider(s) on the base.

**All variants of the base** require a connection to a router for the following features of the phone:

- ◆ You wish to be notified as soon as new software is available for your base on the Internet and load this onto your base.
- ◆ The date and time on your base should be updated by a time server on the Internet.
- ◆ You wish to go online with your base, i.e., use the **Info Centre**, display info services or search for phone numbers in an online directory.

The base will have to be connected to a PC (via a router or directly) if you wish to use the following features of your base:

- ◆ You wish to set up the base using its Web configurator.
- ◆ You wish to use the additional PC software, "**Gigaset QuickSync over Ethernet**" to dial numbers via the PC (e.g., numbers from a PC directory) or to load images or melodies from the PC to your base.

For Internet access you need a router connected to the Internet via a modem (this may be integrated in the router).

##### **Note on Gigaset DX800A all in one**

- ◆ For telephony via the Internet, you need a broadband Internet connection (e.g., DSL) with flat rate (recommended) or volume rate and a router that connects your phone to the Internet. You can find a list of recommended routers on the Internet at:  
[www.gigaset.com/service](http://www.gigaset.com/service)  
From here, go to the FAQ page and select your Gigaset IP telephone. Search for "Router", for example.
- ◆ The base has a second LAN connection which you can use, e.g., to connect your PC to the Internet (router).
- ◆ **Data protection notice:** Further information about the Gigaset.net service data saved can be found at  
[www.gigaset.net/privacy-policy](http://www.gigaset.net/privacy-policy)



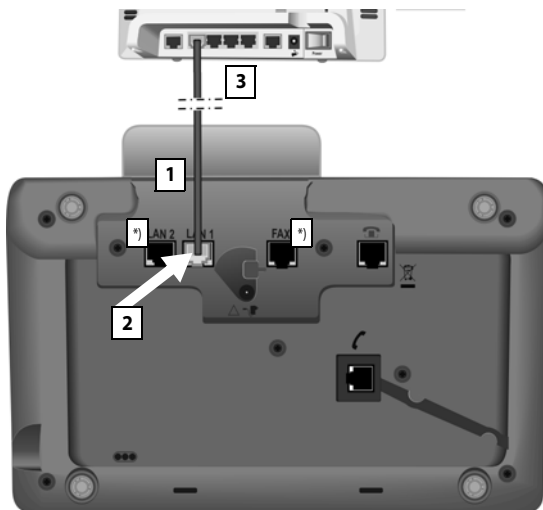

\*) The LAN2 and FAX connections are not available for all devices ( → page 10)

- 1 Guide the end of the Ethernet cable provided (Cat 5 with 2 RJ45 modular jacks) from the rear through the recess in the housing.
- 2 Plug the jack on the Ethernet cable into the LAN port on the underside of the base.
- 3 Then insert the second Ethernet cable plug into a LAN socket on the router.

**Gigaset DX800A all in one:**

**You are now able to establish VoIP connections within Gigaset.net ( → page 40).**

**Gigaset DL500A:**

You have completed the setup for the base.

For more information see page 32, "Date/time".

## Gigaset DX600A ISDN, DX800A all in one: Setting up the base – installation wizard

As soon as the phone is connected to the mains power supply, the firmware is started. If no connections have been generated on the base yet, the installation wizard starts. The wizard allows you to make all necessary settings for your phone.

### Note on Gigaset DX800A all in one

The phone checks which phone connection (analogue fixed line or ISDN) it is connected to.

The following message appears in the display.



► Press the display key **Yes** to start installation.

### Please note

- ◆ The installation wizard only starts if no connection has been configured on the base yet. If connections have already been configured, you can start the VoIP and ISDN wizards (individually) via the menu.
- ◆ Use only the installation wizard on the base, but **not** on a registered handset.



Several individual wizards are combined to form the installation wizard. The individual wizards that start on your device depend on your type of device and the connections to which the device is connected. The following individual wizards are included in the installation wizard:

- 1 ISDN wizard
- 2 IP wizard
- 3 Registration wizard
- 4 Connection wizard

Refer to the following table to see which of the following steps are run on your device and connection type, and which individual wizards are started.

Connection	Procedure
GigasetDX600A ISDN	1. ISDN wizard ( → page 17) 3. Registration wizard 4. Connection wizard
GigasetDX800A all in one for connection to ISDN and VoIP	1. ISDN wizard ( → page 17) 2. IP wizard 3. Registration wizard 4. Connection wizard
GigasetDX800A all in one for connection to the analogue fixed line and VoIP	2. IP wizard ( → page 20) 3. Registration wizard 4. Connection wizard

**Please note:**

- ◆ If the installation wizard is activated, no other handset can access the **Settings** menu on the base.
- ◆ To quit the installation wizard before the process is complete, press and **hold** the red end key . All changes you have already saved using **OK** are retained.
- ◆ To skip a setting, press left on the control key  or the display key **No**.

**1. ISDN wizard: Assigning/entering the connection's MSNs**

Is started on **Gigaset DX600A ISDN, Gigaset DX800A all-in-one** with ISDN connection.

**Prerequisite:** You have connected the base to the ISDN telephone network.

Several numbers (MSNs) were provided by the network provider when you received your ISDN connection confirmation. You can save up to ten numbers (MSNs) on your base. If there is no MSN entered on your base, you can determine the MSNs of your connection with the ISDN wizard, i.e., call them up from the exchange (automatic MSN assignment) or enter them manually.

**Please note**

Not every ISDN provider supports automatic MSN assignment. If this feature is not supported, you must enter the MSNs for your connection manually.

## First steps



- ▶ Press the display key **Yes** to start installation.



- ▶ Press the display key **OK** to start automatic MSN assignment. This process will take some time. **Detecting your ISDN phone numbers (MSNs)...** is displayed on the screen.

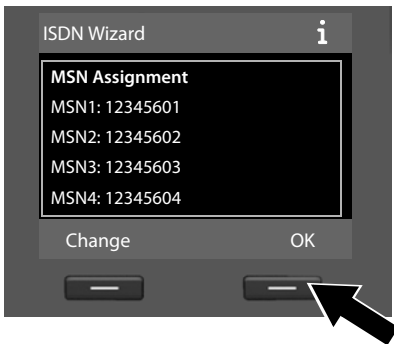

After the MSNs have been successfully assigned, a list containing the MSNs is displayed.

- ▶ Press the display key **OK** to close the ISDN wizard. The display shows **ISDN installation complete**.

### Please note

You can change the name of the MSNs (see detailed user guide for the base on the enclosed CD).

If no MSNs were found, **No MSNs detected.** is shown. You are prompted to enter your MSNs manually:



- ▶ Press the display key **OK** to enter the MSNs manually.

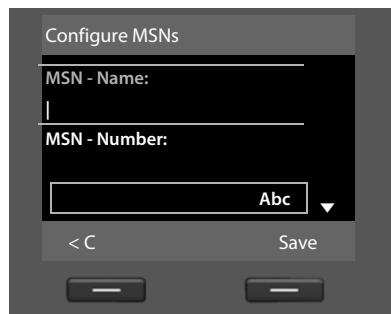

- ▶ Enter a name for MSN 1 via the number keys (max. 16 characters). If you enter nothing, **MSN1** is set.
- ▶ Press **down** on the control key  to switch to entering the MSN.

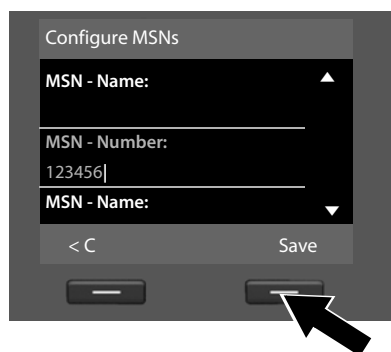

- ▶ Enter your first MSN (without area code; max. 20 digits).
- ▶ Press down on the control key again to switch to the next field.
- ▶ Repeat the above procedure to enter the remaining MSNs.
- ▶ After entering the final MSN. Press the display key **Save**.

The display shows **ISDN installation complete**.

### Gigaset DX800A all in one:

For more information see page 20, "2. VoIP wizard – making VoIP settings".

### Gigaset DX600A ISDN:

For more information see page 26, "3. Registration wizard".

## 2. VoIP wizard – making VoIP settings

Is started on the Gigaset DX800A all-in-one.

You will see the following display:



Before you can use the Internet (VoIP) to phone any other numbers on the Internet, the fixed line or the mobile phone network, you need the services of a VoIP provider who supports the VoIP SIP standard.

**Prerequisite:** You have registered with a VoIP provider (e.g., via your PC) and set up at least one VoIP account (IP account).

To use VoIP, you now need to enter the access data for your VoIP account. You will receive all the necessary data from your VoIP provider. This will include:

### Either:

- ◆ Your user name (if required by VoIP provider)  
The user name of your IP account (caller ID), frequently identical to your phone number
- ◆ Your authentication name or login ID
- ◆ The (login) password registered with the VoIP provider
- ◆ General settings for your VoIP provider (server addresses etc.)

### Or:

- ◆ An auto-configuration code (activation code)

Your Gigaset phone's VoIP wizard can help you make these entries.

### Please note

You can configure up to six VoIP connections. In the phone setup process (no VoIP connection has been configured yet), you configure one VoIP connection. You can configure additional VoIP connections later with the VoIP wizard or with the Web configurator.

## Starting the VoIP wizard

**Prerequisite:** The base is connected to the router. Your router is connected to the Internet (→ page 14).

- ▶ Press on the centre of the  control key or on the right display key **Yes** to start the VoIP wizard.

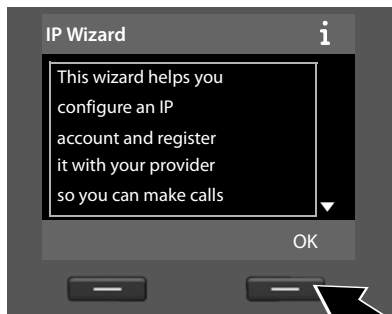

Information regarding the VoIP wizard appears in the display.

- ▶ Press down on the control key , to scroll further.
- ▶ Press the **OK** display key to continue.

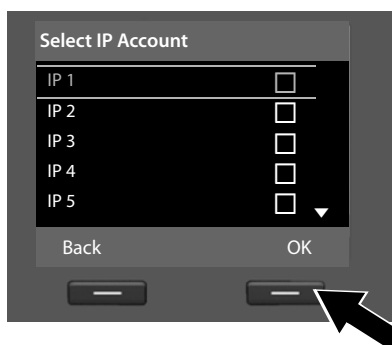

A list of all possible IP connections appears in the display (IP 1 to IP 6). VoIP connections that are already configured are marked with .

- ▶ If necessary, press down on the control key , to select a connection.
- ▶ Press the **OK** display key to continue.

## First steps

You will see the following display:

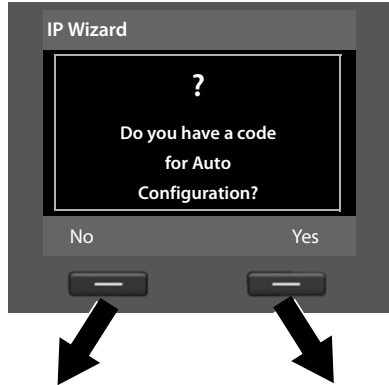

Your VoIP provider has supplied you with an **authentication name/password** and, where applicable, a user name:

- ▶ Press the key below **No** on the display screen.
- ▶ For further information, please see "Downloading VoIP provider data" on page 23.

You have received an **auto configuration code** (Activation Code) from your VoIP provider:

- ▶ Press the key below **Yes** on the display screen.
- ▶ For further information, please see "Entering the auto configuration code" on page 22.

## Entering the auto configuration code



- ▶ Using the keypad, enter the auto configuration code you received from the provider (max. 32 characters).
- ▶ Press the key below **OK** on the display screen.

All data necessary for VoIP telephony is loaded directly from the Internet to your phone.

When all the data has been successfully loaded onto your phone, **Your IP account is registered with your provider.** appears on the display.

- ▶ For further information, please see "3. Registration wizard" on page 26.



## Downloading VoIP provider data

The connection wizard establishes a connection with the Gigaset configuration server on the Internet. Various profiles with general access data for different VoIP providers can be downloaded here.

After a brief period you will see the following display:

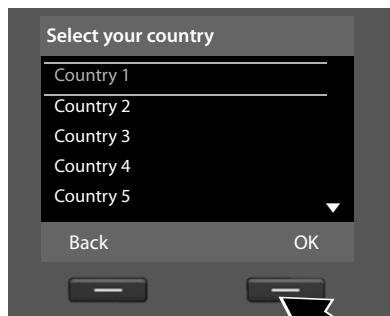

A list of countries is loaded.

- ▶ Press up or down on the control key repeatedly until the country in which you wish to use the phone is selected in the display.

- ▶ Press the key below **OK** on the display screen to confirm your selection.

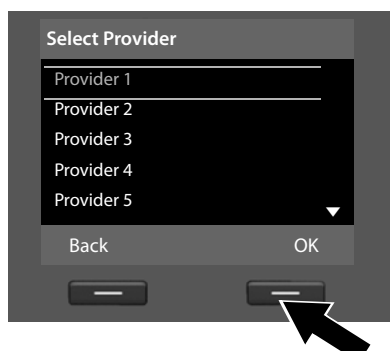

A list of the VoIP providers for which a profile with the general access data is available on the configuration server is displayed.

- ▶ Press up or down on the control key  repeatedly until your VoIP provider is selected in the display.

- ▶ Press the key below **OK** on the display screen to confirm your selection.

The general access data for your VoIP provider will be downloaded and saved on the phone.

### You have not been able to download your provider's data

If your VoIP provider does not appear in the list, i.e., its general data is not provided for download, you must cancel the VoIP wizard:

- ▶ Briefly press the red end key  repeatedly until **Start IP installation wizard?** appears in the display again, and then press the display key **No**.

You can perform the following steps of the installation wizard.

You must then make the required VoIP provider and IP account settings using the Web configurator. You will receive all the necessary provider data from your VoIP provider.

You can change the assignment of the VoIP connection as a send/receive connection at a later time via the telephone menu or the Web configurator.

### Entering user data for your VoIP account

You will now be prompted to enter your personal access data for your VoIP account.

The following are provider-dependent:

◆ **User Name, Authentication Name, Authentication Password**

**Please note ...**

... when entering access data, it is case sensitive.

To switch between upper and lower case and digits, press the **#\*\*** key (several times if necessary). You can see briefly in the display whether upper case, lower case or digit input is selected.

Characters entered incorrectly can be deleted using the left display key below **<C**. The character to the left of the cursor is deleted.

You can navigate within the input field using the control key **↔** (left/right).

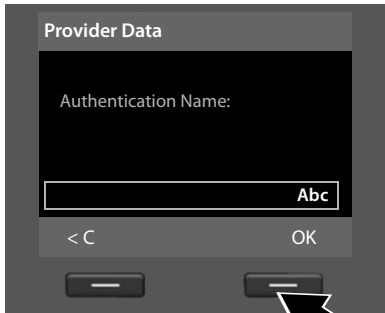

▶ Using the keypad, enter the authentication name that you received from your VoIP provider.

▶ Press the key under **OK** on the display screen.

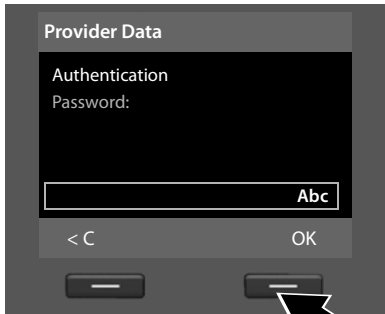

▶ Use the keypad to enter your password.

▶ Press the key under **OK** on the display screen.

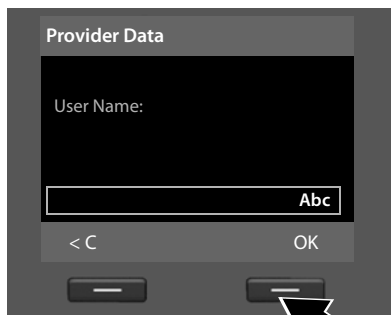

- ▶ Using the keypad, enter the user name that you received from your VoIP provider.
- ▶ Press the key under **OK** on the display screen.



Once you have made all the necessary entries, the VoIP wizard tries to register the base with the VoIP provider.

After successful registration, the message "**Your IP account is registered with your provider.**" appears in the display.

The registration wizard starts.

**Now you can make calls with your phone over the Internet as well as the fixed line or ISDN (dependent on the selected connection)! You can be reached via your VoIP number and your fixed line number or the MSN of your ISDN connection!**

### 3. Registration wizard

Is started on **Gigaset DX800A all-in-one** and **Gigaset DX600A ISDN**.

The registration wizard helps you register handsets to the base.



**Please note**  
Press the left display key **No**, if you do not wish to register any handsets. This closes the registration wizard and the connection wizard is started (→ page 27).

▶ Press the display key **Yes**. The base changes to registration mode.



▶ Start the registration **on the handset** within approx. **60 seconds** according to the handset's user guide.

**Info**  
Press the display key **Info** to display information about registering handsets.

If the handset has been successfully registered on the base, you will see the following display (for approx. three seconds):

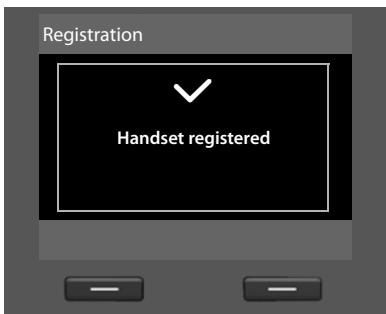

Once a Gigaset handset has been successfully registered, it will change to idle mode. The handset's internal name is shown on the display (**INT 2**, **INT 3** to **INT 7**).

Then "**Register a handset?**" is shown in the display again (see above/page 26).

- ▶ Press the display key **Yes** if you wish to register another handset and perform the steps listed above with this additional handset.  
Press **No** to close the registration wizard and start the connection wizard.

#### Please note

- ◆ By default, the base is assigned the internal name **INT 1** and the internal number 1.
- ◆ The base assigns the lowest free internal number to the handset (possible numbers: 2–7). The handset's internal name is shown in the display e.g., **INT 2**. This means that the handset has been assigned the internal number 2.
- ◆ The internal numbers and names can be changed.

## 4. Connection wizard

Is started on **Gigaset DX800A all-in-one** and **Gigaset DX600A ISDN**.

Using the connection wizard, you can assign the previously configured connections to the internal parties as receive or, if applicable, as send connections. Internal parties are the base, the registered handset, the answering machine of the base and the connected FAX device, if applicable.

- ◆ **Receive connections** are numbers on which you can be called. Incoming calls are only diverted to those internal parties (end devices) for whom the associated connection is assigned as a receive connection.
- ◆ **Send connections** are the numbers that are sent to the called party. The network provider calculates charges based on the send connections. You can assign each internal party a number or the associated connection as a send connection.
- ◆ Each connection (number) of your phone can be both a send as well as a receive connection. You can assign each connection to several internal parties as a send and/or receive connection. It may only be assigned to an answering machine as a receive connection.

### Standard assignment

All connections of the base are assigned as receive connections to the base, the registered handsets and the local answering machine 1 at registration/start-up.

When the phone is connected to the ISDN, the first MSN in the configuration (standard name **MSN1**) is assigned to the devices as a send connection. If no MSNs are configured, the main number of the ISDN connection is used.

If the Gigaset DX800A all in one is connected to the analogue fixed line, the fixed line number is assigned to the devices as a send connection.

### Starting the connection wizard

a.



- ▶ Press the display key **Yes**, if you wish to change the setting for the send and receive connection of the **base** (internal name **INT 1**).
- ▶ Press the display key **No**, if you do not wish to change the setting for the base.

b. (Display for ISDN connection)



The list of receive connections currently assigned is displayed.

Press down on the control key  to scroll through the list if necessary.

- ▶ Press the display key **Change**, if you wish to change the receive connection setting for the base.
- ▶ Press the display key **OK**, if you do not wish to change the setting.

Or:

(Display for fixed line connection)

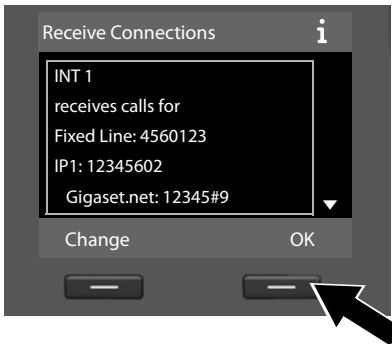

#### Note on DX800A all in one:

A Gigaset.net phone number is already assigned to the base on delivery. You can also assign the Gigaset.net number to all connected devices as a receive connection.

Press **OK** to skip the following steps. Continue from → e.

Press **Change** to display the following:

## C. (Display for ISDN connection)



If you do not want calls to MSN1 or your fixed line connection number signalled on the base:

- ▶ Press **right** on the control key  to set to **No**.



**Or:**

(Display for fixed line connection)

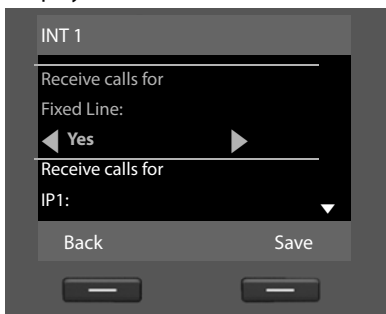

d. (Display for ISDN connection)



- ▶ Press **down** on the control key  to switch to the next phone number. Select either **Yes** or **No** as described above.
- ▶ Repeat the steps for each phone number.
- ▶ Press the display key **Save** once you have finished configuring the settings for the base.

Or:

(Display for fixed line connection)

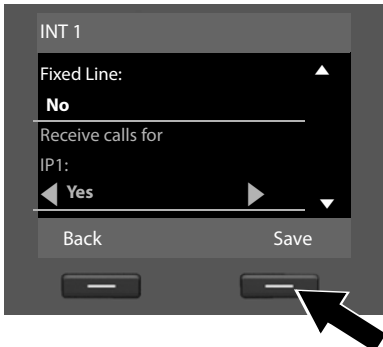

The updated list of receive connections is displayed one more time for you to check.

Press the display key **OK** to confirm the assignment.

e.

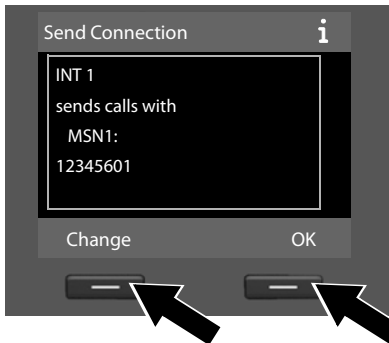

The send connection currently set for the base is displayed: **MSN1** for connection to the ISDN and **Fixed Line** for connection of the Gigaset DX800A all in one to the analogue fixed line.

- ▶ Press the display key **OK**, if you do not wish to change the setting. The following step is skipped.
- ▶ To change the setting, press the display key **Change**.



f.



If the base is to make calls via a different connection/phone number:

- ▶ Press **right** on the control key  repeatedly, until the required connection is displayed.

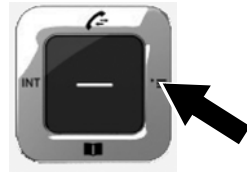

- ▶ Press the display key **Save** to save the settings.

If handsets are already registered to the base, you are requested to assign send and receive connections for the handsets. The following is shown in the display:

#### Assign connections to handset INT ...?

- ▶ Perform steps a. to f. for each registered handset.

Subsequently, you are requested to assign the receive connections to the three answering machines on the base. "Assign connections to answering machine ?" is shown in the display.

- ▶ Perform steps a. to d. for each answering machine.

**Please note:** Each connection may only be assigned to one of the three local answering machines as a receive connection. If you assign a receive connection to an answering machine and this connection is already assigned to another answering machine, the "old" assignment is deleted.

After successfully configuring the settings, you will briefly see the following display:

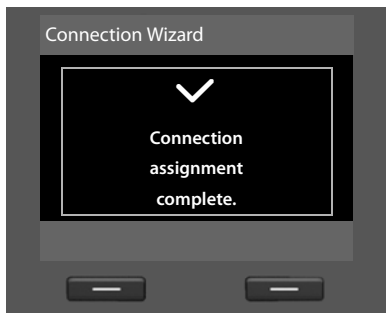

## Completing the installation

This completes the installation. The following is shown in the display:

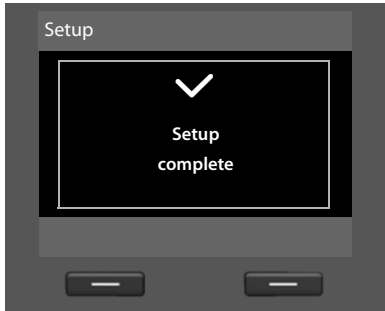

Afterwards, the base changes to idle status (for an example of the display in idle status → page 4).

The answering machines of the base to which you assigned a receive connection are activated and switched on in answer and record mode with a standard announcement (→ page 42).

## Date/time

To ensure you have the correct time for incoming calls and to use the alarm clock and calendar, the date and time must be set.

There are various methods of setting the date and time:

◆ Gigaset DX800A all in one

For an ISDN connection, the base updates the date and time from the ISDN network the first time you make an outgoing, external call.

For an analogue fixed line connection, you must manually enter the date and time (see below).

You can also configure your base so that the date and time is transferred from a time server on the Internet (at regular intervals).

◆ Gigaset DX600A ISDN

The base updates the date and time from the ISDN network the first time you make an outgoing, external call.

You can also configure your base so that the date and time is transferred from a time server on the Internet (at regular intervals).

Or you set the date and time manually on the base (see below).

◆ Gigaset DL500A

By default, your base is configured so that the date and time are transferred from a time server on the Internet, provided it is connected to the Internet. You can also set the date and time manually via the base menu or one of the registered handsets (see below).

You can activate/deactivate the synchronisation with a time server via the Web configurator. Refer to the Web configurator's user guide on the enclosed CD.

## Setting the date and time manually

If the date and time have not been set, the time will flash in the base's idle display (00:00) and **Time** is displayed above the right display key.



- ▶ Press the key under **Time** on the display screen.  
Enter day, month and year as an 8-digit number via the keypad, e.g.,  for 04/09/2010. The displayed date is overwritten.
- ▶ Press down on the control key  to scroll to the time entry line.
- ▶ Enter the hours and minutes in 4-digit format via the keypad, e.g.,  for 07:15 am.
- ▶ Press the display key **Save** to save the settings.

## Guide

Now you have successfully set up your base, you will certainly want to adapt it to your personal requirements. Use the following guide to quickly locate the most important subjects.

This user guide only briefly describes a few functions of your phone. You can find a detailed description of the entire range of functions of your phone in the **detailed user guide** on the enclosed CD. The presentation of procedures used in the following are also described here.

Users who are unfamiliar with menu-driven devices such as other Gigaset phones can read the detailed user guide to find out how to operate the base.

You will also find a user guide for the **Web configurator** of your telephone on the enclosed CD. You can use it to make settings for your phone on the PC.

Information on ...	... is located here.
Making external calls and accepting calls	▶ page 35
Setting the ringer and volume	▶ page 50
Setting the receiver volume	▶ page 49
Assigning function keys on the base	▶ page 48
Using the local directory and online directories on the Internet	▶ page 38
Transferring directory entries from existing Gigaset handsets to the base	▶ page 38
Writing, sending, receiving SMS messages	▶ page 41
Registering Bluetooth devices, using "Link2mobile"	▶ page 46

If you have any questions about using your phone, please read the tips on troubleshooting in the phone's long user guide or contact our Customer Care team.

## Making calls

If the display backlight is deactivated (→ page 49), it can be reactivated by pressing any key.

### Making an external call

External calls are calls made via the public telephone network (fixed line, mobile phone network) or via the Internet (VoIP).

#### Please note



##### Gigaset DL500A:

For this device, the following send and receive connections mentioned, as well as the connection selection, are only relevant if you use the Link2mobile function (→ page 47), i.e., if you wish to make a call from your base via the GSM connection of your mobile phone.



In general, the fixed line connection is your send and receive connection.

#### Prerequisite:

A specific connection is assigned to the base as a send connection.

  Enter the number and pick up the receiver.



Or:

  Pick up the receiver and enter the number.

Instead of picking up the receiver, you can also press the handsfree key  or the **Headset** (→ page 48) function key to make a call using the handsfree function or headset.

### Connection selection at each call

**Prerequisite:** "Select at each call" is assigned to the base (→ page 27).

  Enter the number and pick up the receiver. The list of available connections is displayed.



 Select connection.

 **Dial** Press the display key.

## Making an internal call

Internal calls using registered handsets are free of charge.

### Calling a specific handset

-  Initiate internal call.
-  Select the internal party.
-  Lift the receiver.



If the internal party cannot be reached (e.g., outside of range), does not answer or if there are already three internal connections, the busy tone sounds.

### Calling all internal parties ("group call")

-  Press and hold left on the control key.

All handsets are called.

## Ending a call

-  Replace the receiver or press the red end key .

If you make a call with a headset:

- ▶ Press the **Headset** function key or red end key  on the base.

## Accepting a call

An incoming call is indicated in three ways: by ringing, by a display on the screen and by the flashing handsfree key .

#### Please note

Only calls to the receive connections assigned to the base are signalled.

Accept the call by:

- ▶ Picking up the receiver.
- ▶ Pressing the handsfree key .
- ▶ Pressing the display key **Accept**.
- ▶ You can also divert the call to the answering machine (→ page 44).

To deactivate the ringer, press the **Silence** display key. You can accept the call as long as it is displayed on the screen.

## Activating/deactivating handsfree/open listening mode

---

- ▶ Press the handsfree key  to activate/deactivate open listening in receiver mode and when listening to the answering machine.

### Activating handsfree mode while dialling



Enter the number and press the handsfree key.

Ending the call:



Press red end key.

### Switching from receiver to handsfree mode

**Prerequisite:** You are making a call via the receiver or via the receiver with open listening mode activated.



Press and hold the handsfree key until you have put the receiver down.





If the handsfree key does not light up, press the key again.

### Switching from handsfree to receiver mode



Pick up receiver. The speaker on the base is deactivated.

#### Please note

In handsfree mode, you can adjust the handsfree volume with the  and  keys.

## Muting the base

---

Using the mute key  you can switch the microphone of the receiver, the base (handsfree mode) and a connected headset off or on again during an external call (also during a conference call or call swapping). If the microphone is deactivated, **Microphone is off** is displayed.

## Making calls using network services

---

Network services are functions that your network provider makes available to you, such as:

- ◆ Diverting calls to another telephone connection
- ◆ Anonymous calling
- ◆ Making consultation calls during a call
- ◆ Swapping between two callers
- ◆ Setting up a conference
- ◆ Transferring calls to another phone
- ◆ Initiating a ringback when busy/no reply

The long user guide on the enclosed CD describes in detail how to use these network services on your base.

## Using lists

---

The options are:



- ◆ Redial list
- ◆ Incoming message list
- ◆ Call lists
- ◆ Missed alarms list
- ◆ Answering machine list

### Redial list



---

The redial list contains the 20 numbers last dialed with the base (max. 32 digits).

#### Manual redial

-  Open the redial list.
-  Select an entry.
-  / **Dial** Lift the receiver or (a line is already in use) press the display key **Dial**.

#### Automatic redial

-  In idle status: press key.
-  Select an entry.
- Options** → **Automatic Redial**  
Select and press **OK**.

The number is automatically dialed at fixed intervals. "Open listening" is activated, the microphone is deactivated.

- ▶ If the party answers:  
Lift receiver .
- ▶ To cancel the redial:  
Press any key.

## Call lists





---

**Prerequisite:** Calling Line Identification Presentation (CLIP)

The options are:

- ◆ Accepted calls list
- ◆ Outgoing calls list
- ◆ Missed calls list
- ◆ List of all calls

#### Opening call lists:

- ▶ In idle status: Press  or  → 
- ▶ Select list using  and press **OK**.

To call a number from the list:

- ▶ Select an entry. Lift receiver .

To copy the number to the directory:

- ▶ Select an entry.  
**Options** → Copy to Directory **OK**.

### Opening lists with the message key

---

Use the message key  to open the following lists:

- ◆ Answering machine list or network mailbox, if your network provider supports this function and quick dial is set for the network mailbox
- ◆ Using the incoming message list
- ◆ Missed calls list
- ◆ Missed alarms list

An advisory tone sounds as soon as a **new entry** appears on a list. The message key  flashes. In **idle status**, icons are shown on the display to indicate new messages (→ page 4).

After pressing the message key , you can see all lists containing messages and the network mailbox list.

To open the list:

Press the  key. Select list.

## Using directories

---

The options are:

- ◆ (Local) directory (→ page 38)
- ◆ Public online directory/classified directory on the Internet (→ page 39)
- ◆ (dependent on provider) Personal online directory on the Internet
- ◆ On the Gigaset DX800A all in one: Gigaset.net directory (→ page 40)

## Using the local base directory

---

Not only can you create a personalised directory for your base, but you can send entries from it to handsets too (→ page 38).

### Opening the directory

- ▶ In idle status or during an external call: press down on the control key .

### Saving number(s)

---

 → <New Entry>

- ▶ You can enter data in the following fields:

#### First Name:/Surname:

Enter first name and/or surname.

#### Phone (Home):/Phone (Office):/

#### Phone (Mobile):

Enter a number in at least one of the three fields.

#### E-Mail: (optional)

Enter e-mail address.

#### Anniversary: (optional)

Select **On** or **Off**.

With setting **On**:

Enter **Anniversary (Date)** and **Anniversary (Time)** and select reminder type: **Anniversary (Signal)**.



#### Caller Melody (VIP):/

#### Caller Picture: (optional)

Label the entry as **VIP**. Recognize VIP calls by the ringer. Select a ringer and picture, if required. **Prerequisite:** Calling Line Identification

**Save** Press the display key.

### Editing entries



 →  (Select entry).

**View Edit** Press the display keys one after the other.

- ▶ Perform changes and save.

### Dialling with the directory

---

 →  (Select entry).

 Pick up the receiver.

Or during a call:

**Dial** Press the display key.

If the entry contains several numbers, the icons for the numbers stored are displayed:

 / /.

 Select a number.



**Dial** Press the display key.

### Exchanging directory/entries with handsets

---

**Prerequisites:** The handset is registered on the base and supports this function. The base is in idle status.

#### Sending

 →  (Select entry) → **Options**  
→ **Copy Entry/Copy List** → **to Internal**

 Select the handset from the internal list and press **OK**.

#### Receiving

- ▶ Start the transfer on the handset.

The transfer appears in the base display.

#### Please note

- ◆ Incoming external calls interrupt the transfer.
- ◆ Entries with identical numbers are not overwritten.
- ◆ Anniversary reminders, pictures and sounds are not transferred.





## Using online telephone directories

---

You can use public online directories (= online directories and classified directories e.g., "Yellow Pages") depending on your provider. You can set the online telephone directory using the Web configurator.

When the base is in idle status:

-  Press and **hold**.
-  Select an online telephone directory and press **OK**.

### Searching for an entry

- ▶ Enter name/business type **and** place or number. Start the search with **Search**.
- ▶ If several towns/cities are listed with the same name, select the town/city and continue the search.
- ▶ If the hit list is too long, start a detailed search using **Refine** or **Options** → **Refine search** and refine or expand the search criteria (e.g., with street name).
- ▶ If no party is found, you can start a new search using **New**.

### Calling parties

- ▶ Select an entry in the hit list and pick up the receiver .

If the entry contains several phone numbers, these are displayed in a list.

- ▶ Using , select a number and press the display key **Dial**.



## Using the private net directory

---

Some providers offer users the option of creating and managing a private net directory on the Internet.

- ▶ You can create your private net directory using your PC's Web browser.

In idle status:

-  Press and **hold**.
-  Select the private net directory and press **OK**.

### Calling an entry

- ▶ Select an entry and pick up the receiver .

If the entry contains several phone numbers, these are displayed in a list.

- ▶ Using , select a number and press the display key **Dial**.

## Using the Gigaset.net directory (Gigaset DX800A)

Using **Gigaset.net** (a VoIP-Service of Gigaset Communications GmbH) you can **directly** (without an account or other settings) call other Gigaset.net users free of charge over the Internet. Every Gigaset VoIP device is therefore assigned a Gigaset.net phone number by default.

### Opening the Gigaset.net directory

The base is in idle status.



Press and **hold**.



If necessary, select **Gigaset.net** and press **OK**.

When you open the Gigaset.net directory for the first time, you are requested to enter a nickname for your connection. You are entered into the Gigaset.net directory under this name.

### Data protection note

When you enter your nickname, this is saved on a central Gigaset server. The nickname appears in the Gigaset.net directory, and other subscribers that use the Gigaset.net service can call you using this nickname.

**By entering your data, you agree to having your data saved.** If you do not want this, you can cancel the operation.

Further information about the Gigaset.net service data saved can be found at

[www.gigaset.net/privacy-policy](http://www.gigaset.net/privacy-policy)

### Searching for subscribers

- ▶ Enter nickname or part of a nickname (max. 25 characters) and press **Search**.
- ▶ If the hit list is too long, start a detailed search using **Refine**.
- ▶ If no subscriber is found, you can start a new search using **New**.

### Calling subscribers



Select the subscriber from the hit list and pick up the receiver.

## Sending SMS (text messages)

---

Your base is delivered ready to send SMS messages as soon as the phone is connected to the fixed line/ISDN.



### Prerequisites:

- ◆ Calling Line Identification is enabled.
- ◆ Your network provider supports the SMS service (information on this is available from your network provider).
- ◆ To receive SMS messages, you must be registered with your SMS service provider. This happens automatically when you send the first SMS via the provider's service centre.

### Gigaset DX800A all in one/DX600A ISDN:

If you wish to receive SMS messages via several connections, you must register each connection separately with your service provider.

Define the connection via which you want to send SMS (**Send via**) as follows:

 →  **Messaging** → **SMS** → **Settings** → **Service Centres**

## Writing/sending SMS

---

An SMS can be up to 612 characters. If there are more than 160 characters, the SMS is sent as a **linked** SMS (up to 4 SMS messages).

 →  **Messaging** → **SMS**

**New SMS** Select and press **OK**.



 Write SMS.

**Options** Press the display key.

**Either:**

**Send** Select and press **OK**.

**SMS** Select and press **OK**.

 /  Select the number with the area code (even if you are in that area) from the directory or enter it directly.

**Send** Press the display key. The SMS is sent.

**Or:**



**Save** Select and press **OK**. The message is saved in the draft list. You can edit and send it later.

If you are interrupted by an external call while writing an SMS, the text is automatically saved in the draft message list.



## Receiving an SMS

---

All received SMS messages are saved in the incoming list. Linked SMS messages are displayed as **one** message. If this is too long or is not transferred completely, it is split into individual messages.



New SMS messages are indicated by the  icon in the display, the  message key flashing and an advisory tone sounding.

You can open the incoming message list with the message key  or via:

 →  **Messaging** → **SMS** → **Incoming**.

## Reading SMS, managing lists

---

 →  **Messaging** → **SMS** → **Incoming/Draft**

 Select SMS.

**Read** Press the display key.

**Options** gives you access to functions including the following:

- ◆ **Delete Entry:** Delete SMS.
- ◆ **Send:** Send/forward SMS.
- ◆ **Edit:** Edit and send SMS.
- ◆ **Reply** (Incoming message list): Write a new SMS to the sender.

## Operating the base answering machine

---

You can operate the answering machine that is integrated into the base using the keys on the base (→ page 3), the phone menu, via a registered Gigaset SL78H, SL400H or S79H handset or by remote operation (other phone/mobile phone). You can only record your own announcement message or advisory message via the base or a handset.

 →  → **Announcements**

### Gigaset DX800A all in one, DX600A ISDN

Each of the devices has three answering machines (AM1, AM2, AM3), which can be activated and used independently of each other.

Once the base has been set up, AM1 is activated and all base connections are assigned to it as receive connections. AM2 and AM3 are available once you have assigned at least one receive connection to them (→ page 27).

Each answering machine only receives calls that are directed to its receive connections. Each answering machine can only be operated via the end devices (base/handsets) to which at least one of the machine's receive connections is assigned.

## Operating via the base

---

The speaker activates **automatically** if you receive an acoustic prompt or message while operating. You can deactivate the handsfree mode by picking up the receiver.

Operation via the menu on the base is the same as operation via a registered Gigaset SL78H, SL400H or S79H handset.

## Activating/deactivating and setting answering machine mode

---

You can choose between **Answer & Record**, **Answer only** and **Alternating**. By using the **Alternating** setting, you can activate answer and record mode for a set period of time; outside this period the caller will only hear the announcement.

 →  → **Activation** (✓ = on)

 If necessary, select an answering machine.

**Change** Press the display key.

► You can enter data in the following fields:

### Activation:

Select **On** or **Off** to activate/deactivate the answering machine.

### Mode:

Select **Answer & Record**, **Answer only** or **Alternating**.

For **Alternating**:

### Record from:/Record until:

Enter the start and end of the period in 4-digit format (time **must** be set).

Enter hours/minutes for the end of the period in 4-digit format.



**Save** Press the display key.

## Activating the answering machine via the key on the base

Gigaset DX800A all in one, DX600A ISDN:

- ▶ Press the  key to activate or deactivate all answering machines that share a receive connection with the base.



If several answering machines are assigned to the base and these are not all deactivated, proceed as follows:

1. Press the  key: All answering machines assigned to the base are deactivated.
2. Press the  key: All answering machines are activated.

Gigaset DL500A



- ▶ Press the  key to activate or deactivate the answering machine.

## Playing back messages

New messages that have not yet been played back are indicated by the  icon in the second display line and by the  key flashing.

-  Press the message key.
- ▶ Select an answering machine and press **OK**.

Or:





-  Press the play key.
-  If necessary, select an answering machine and press **OK**.

If there are new messages, playback then begins with the first new message.



If there are no new messages, the old messages are played back.



## Stopping and controlling playback



During message playback:

-  /  Stop playback. Press  /  again to resume **or**

- Options** Press the display key. To continue select **Continue** and press **OK**.

-  (press and hold) or  During time stamp playback: Skip to previous message. During message playback: Skip to the start of the current message.

-  (press briefly) or  During time stamp playback: Skip to previous message. During message playback: Repeat the last five seconds of the current message.

-  or  Go to the next message.

If playback is interrupted for over a minute, the answering machine returns to idle status.

## Deleting messages

You can either delete all old messages together or individually. You can only delete new messages once the time stamp has been played back along with the first few seconds of the message.

### Deleting all old messages

During playback or pause:

- Options** → **Delete Old List OK**
- Yes** Confirm prompt.



### Deleting individual messages

During playback or pause:

- Delete** / 

### Accepting a call from the answering machine

---

▶ While recording a call:  / **Accept** / 

Recording stops and you can speak to the caller.

### Diverting an external call to the answering machine

---

You can divert an incoming external call to the answering machine.

#### Prerequisites:

- ◆ Gigaset DX800A all in one, DX600A ISDN:  
The call comes in on a receive connection that is assigned to an answering machine.
- ◆ The answering machine is activated and not in use.

For calls to your analogue fixed line:

 Press the display key.

For calls to your ISDN connection or one of your VoIP connections:

**Options** Open the menu.

#### Divert to AM

Select and press **OK**.

The answering machine starts immediately in answer and record mode.

### Activating/deactivating two-way record

---

You can record an **external** call with the answering machine.

#### Prerequisite:

You are conducting an external call:

- ▶ Inform the caller that the call is being recorded.

**Options** → **Two-Way Record**  
Select and press **OK**.



**End** End two-way record.

### Activating/deactivating call screening

---

While recording a message, you can screen a call via the speaker on the base or on the registered handsets.

#### Permanently activating/deactivating call screening

 →  → **Call Screening**  
→ **Desktop Phone / Handset** ( = on)

**Change** Activate/deactivate call screening.



#### Deactivating call screening for the current recording

You can deactivate the function during the recording.

On the base:

**Silence** Press the display key.

#### Answering a call

 /  Press the handsfree key or pick up the receiver.

### Operating when on the move (remote operation)

---

You can check and activate your answering machine from any other telephone (hotel, pay phone etc.).

#### Prerequisites:

- ◆ You have set a system PIN other than 0000 (→ page 51).
- ◆ The phone you are using for remote operation has tone dialling (DTMF) i.e., you hear different tones when you press the keys.
- ◆ The connection via which you call is assigned to the answering machine as a receive connection.

## Calling the answering machine and playing messages

---



Dial your own number.



When you hear your announcement, press **9** and enter the system PIN.

The answering machine will tell you whether you have any new messages. The messages are now played back. You can now operate the answering machine with the keypad.

You use the following keys:

- 1** During time stamp playback:  
Skip to previous message.  
During message playback: Skip to the start of the current message.
- 2** Stop playback. Press again to resume.
- 3** Go to the next message.
- 4** Repeat the last five seconds of the message.
- 0** During message playback:  
Delete current message.
- \*** Change the status of a previously played back message to "new".

## Cancelling remote operation

- ▶ Press the end call key or replace the receiver.

## Activating the answering machine

- ▶ Phone home and let the phone ring until you hear: "Please enter PIN" (approx. 50 seconds).
- ▶ Enter the system PIN.

Your answering machine is activated.  
The messages are now played back.

# Registering Bluetooth devices

Via Bluetooth™ your base can communicate with other Bluetooth devices wirelessly (range approx. 10 m). You must activate Bluetooth on the base and register the Bluetooth devices.

 → **Bluetooth** → **Activation**  
Select and press **Change**,  
( = activated).

If Bluetooth is activated, the  icon appears in the idle display (→ page 4).

You can register the following devices via Bluetooth:

- ◆ A Bluetooth headset
- ◆ Up to five Bluetooth GSM mobile phones or data devices (PC, PDA)

## Registering devices – recording them in the list of trusted devices

The activated Bluetooth device is in range.

 → **Bluetooth** → **Search for Headset** / **Search for Mobile** / **Search for Data Device**

The Bluetooth names/addresses of the devices found are displayed in a list (if necessary, abbreviated). In the list:

 Select the device to be registered.

**Options** Press the display key.

### Trust Device

Select and press **OK**.

If five data devices/mobile phones are already registered, the message **Select device to be replaced and trust again** is displayed:

**Yes** Confirm.



 Select the registered device to be overwritten and press **OK**.

 If necessary, enter a PIN of your choice or the PIN of the Bluetooth device **to be registered** and press **OK**.

Generally you can enter a PIN of your choice for a data device/GSM mobile telephone. You must also enter this PIN in the data device/mobile phone (handshake).

For a headset, you only need to enter a PIN if the headset transmits a PIN not equal to 0000. A previously registered headset is automatically de-registered.

In addition to the device names, various icons with the following meaning are displayed:

Icon	Meaning
	Bluetooth headset
	Bluetooth data device
	Bluetooth mobile phone

## Using a Bluetooth headset

### Recommendation

We recommend you assign the **Headset** function to one of the function keys of the base (→ page 48) and use this to transfer/accept calls to/on the headset, even if your headset has a push-to-talk key.

## Accepting/transferring calls on the headset

**Prerequisite:** Bluetooth is activated. The headset is registered and in range.

You are making a call on the base or a call is signalled on the base.

- ▶ Press the **Headset** function key on the base to accept the call on the headset.

## Making calls

- ▶ Enter the phone number on the base and press the **Headset** function key on the base.



## Using GSM mobile phones – Link2mobile

---

You can make a call on your base and/or a registered handset via the GSM connection of your Bluetooth GSM mobile phone.



### Prerequisites:

- ◆ Bluetooth is activated on the base.
- ◆ The mobile phone is connected to the base ("activated"). Only one registered GSM mobile phone can be activated/connected at a time.
- ◆ The mobile phone is in range of the base (less than 10 m).
- ◆ The mobile phone network connection is assigned to the base as a send and receive connection.

You can change the assignment via:

 →  **Settings** → **Telephony**  
→ **Send Connections/**  
**Receive Connections**

### Activating registered mobile phones

 →  **Bluetooth** → **Known Devices**

 Select a mobile phone.  
(✓ = activated))

**Options** Press the display key.

### Connect Mobile

Select and press **OK**.

When you register another mobile phone, it is automatically activated. The previously activated mobile phone is deactivated at the same time.

### Establishing a connection

A connection is automatically established between the base and an activated mobile phone in range:

- ◆ If a call comes in on the GSM connection of the mobile phone
- ◆ If you try to make a call on the base via the GSM connection (select GSM connection as send connection)

### Making calls via the GSM connection

If the prerequisites are fulfilled, you can make calls on your base via the GSM connection as described in the "Making calls" chapter on page 35.

## Setting up the base

---

Your base is preconfigured but you can change the settings to suit your individual requirements.

### Accessing functions and numbers quickly

---

You can program the six function keys on the right-hand side of the base and the display keys (in idle status). You can assign a phone number (quick dial) or a base function to each of these keys and change the assignment.

The number is then dialled or the function started by simply pressing a key.

### Changing key assignments

---

In idle status:

- ▶ Press and **hold** the display/function key until a list of possible key assignments is displayed.
- ▶ Select a function or **More Functions...** (provides additional functions) and press **OK**.

Function key assignment: You can make a note of the key assignment on the insert strip next to the respective key ( → page 69).

### Starting the function, dialling the number

---

When the base is in idle status:

- ▶ **Briefly** press the function or display key.

## Setting the display

---

### Setting the screensaver/slide show

---

You can display a screensaver when the base is in idle status. It will conceal the calendar, date, time and name.

If a screensaver is activated, the **Screensaver** menu option is marked with .

 →  **Settings** → **Display**  
→ **Screensaver**

The current setting is displayed.

- ▶ You can enter data in the following fields:

#### Activation:

Select **On** or **Off**.

#### Selection:

Select screensaver with .

**Save** Press the display key.

The screensaver is activated approx. 10 seconds after the display has changed to idle status.

If the screensaver conceals the display, **briefly** press the red end key  to show the idle display.

## Setting the brightness and time control for the display backlight

You can set the brightness of the display on your base and specify a timeframe during which the display on the base is completely deactivated e.g., at night (reactivates as soon as a key is pressed).

 →  **Settings** → **Display**  
→ **Backlight**

The current setting is displayed.

- ▶ You can enter data in the following fields:

### Time Control

**Prerequisite:** The date and time have already been set.

Select **On** or **Off**.

For **Time Control = On:**

**Display off from:**

Enter time in 4-digit format.

**Display off until:**

Enter time in 4-digit format.

### Brightness:



Set the brightness of the display backlight with . You can select from five brightness levels.

- ▶ Press the display key **Save**.

## Changing the handsfree/receiver volume

You can set the handsfree volume and the receiver volume, as well as the volume of a connected wire-bound headset to five different levels.

### In idle status

 →  **Settings** → **Audio Settings**  
→ **Call Volume**

You will hear a test tone.



Set the receiver volume.



Scroll to the Speaker line.





Set the handsfree volume.

**Save**

Press the display key to save the setting.

### During a call

- ▶ Set the volume using the  and  keys.
- ▶ Press **Save** if necessary to permanently save the setting.

## Setting ringers



---

### Setting the volume

---

You can choose between five volumes and the "crescendo" ringer.

You can set different volumes for the following functions:

 →  **Settings** → **Audio Settings**  
→ **Ringer Settings** → **Volume**

 If necessary, set the volume for internal calls and appointment notification.

 Scroll to the next line.

 If necessary, set the volume for external calls.



**Save** To save the setting.

### Setting the ringer melody

---



You can select various ringers, melodies or any sound from the resource directory.

In idle status:

 →  **Settings** → **Audio Settings**  
→ **Ringer Settings** → **Melodies**

 **Internal calls**, **For external calls** or select a receive connection.

 Select a melody.

  Where necessary, select the next connection and set a melody etc.

**Save** To save the settings.

**Or:**  
(Gigaset DX600A isdn, DX800A-all-in-one)

 Select **All calls**.

 Select a melody.

**Save** Press the display key.

**Yes** To confirm the settings.

The setting for all calls will not work as soon as you change the setting for an individual connection.

## Setting time control for external calls

---

You can specify a time period when you do not want the base to signal external calls e.g., during the night.

**Prerequisite:** The date and time have already been set.

 →  → **Audio Settings**  
→ **Ringer Settings** → **Time Control**

▶ You can enter data in the following fields:

**For external calls:**  
Select **On** or **Off**.

For **For external calls = On:**

**Suspend ring. from:/Suspend ring. until:**  
Enter the start and end of the period in 4-digit format.



**Save** To save the setting.

### Please note

During this period, you will continue to receive calls on the base from numbers to which you have assigned a personalised melody in the directory (VIP).

## Silencing the ringer for anonymous calls

---

 →  **Settings** → **Audio Settings**  
→ **Ringer Settings** → **Anon. Call Silencing**  
( = on)

## Activating/deactivating the ringer

---

### Deactivating the ringer permanently

 Press and **hold** the star key.

The  icon appears in the display.

### Reactivating the ringer

 Press and **hold** the star key.



### Deactivating the ringer for the current call

**Silence** Press the display key.

## Activating/deactivating advisory tones

---

In idle status:

 →  **Settings** → **Audio Settings**  
→ **Advisory Tones**

▶ You can enter data in the following fields:

**Key Tones:**

Select **On** or **Off**.

**Confirmation:**

Select **On** or **Off**.

 Save setting.

## Changing the system PIN

---

 →  **Settings** → **System**  
→ **System PIN**



If necessary, enter the current system PIN of the base and press **OK**.



Enter your new system PIN and press **OK**.

## Setting your own area code

---

You should save your own country and area code in the base, particularly if you want to make calls with the base via the GSM connection of your Bluetooth mobile phone (Link2mobile). Some of these numbers are already preconfigured.

 →  **Settings** → **Telephony**  
→ **Area Codes**

▶ Add missing numbers or replace numbers in the rows **International code** and **Local area code** and press .

## Service (Customer Care)

---

You have questions? As a Gigaset customer, you can take advantage of our comprehensive service offerings. You can find help quickly in this User Manual and in the service pages of our Gigaset online portal.

Please register your phone right after purchase.

This enables us to provide you with even better service regarding questions or a warranty claim. Your personal user account enables you to directly contact our customer service by email.

Our representatives are available on the telephone hotlines for more advanced questions or immediate consultation.

### **United Kingdom**

[www.gigaset.com/uk/service](http://www.gigaset.com/uk/service)

**Service Hotline: 0845 367 0812**

(local call cost charge)

### **Ireland**

[www.gigaset.com/ie/service](http://www.gigaset.com/ie/service)

**Service Hotline: 1850 777 277**

(6.6561 Ct./Call)

Please note that if the Gigaset product is not sold by authorised dealers in the national territory the product may not be fully compatible with the national telephone network. It is clearly specified on the box near the CE mark as well as on the bottom of the base station for which country/countries the equipment has been developed. If the equipment is used in a manner inconsistent with this advice or with the instructions of the manual and on the product itself, this may have implications on the conditions for warranty or guarantee claims (repair or exchange of product).

In order to make use of the warranty, the product purchaser is asked to submit a receipt which proves the date of purchase (date from which the warranty period starts) and the type of goods that have been purchased.

For questions about VoIP access, please contact the respective service provider.

## Questions and answers

---

If you have any questions about the use of your base, visit our website at

[www.gigaset.com/service](http://www.gigaset.com/service)

for assistance 24/7. You will find a list of common problems and possible solutions in the long user guide on the enclosed CD.

## Zulassung

---

**DL500A:** This device is intended for analogue phone lines in the UK and on the Irish network.

**DX600A:** This device is intended for the ISDN telephone connection in the UK and on the Irish network.

**DX800A:** This device is intended for analogue phone lines or ISDN telephone connection in the UK and on the Irish network. Voice over IP telephony is possible via the LAN interface if an additional modem has been connected.

Country-specific requirements have been taken into consideration.

We, Gigaset Communications GmbH, declare that this device meets the essential requirements and other relevant regulations laid down in Directive 1999/5/EC.

A copy of the 1999/5/EC Declaration of Conformity is available at this Internet address:

[www.gigaset.com/docs](http://www.gigaset.com/docs)

**CE 0682**





# Menu overview Gigaset DX800A all in one

**Please note**

Your base menu displays, different functions depending on the connection type (Internet and analogue fixed line or Internet and ISDN).  
 Functions that are only displayed if the telephone is connected with the analogue fixed line additionally say "**only for fixed line connection**". Correspondingly, the ISDN-specific functions say "**only for ISDN connection**".

To open the main menu: press  when the base is in **idle mode**.

 **Select Services**

Next Call	Withhold Number	Only for ISDN connection
	Keypad Control	Only for ISDN connection
Withhold No. Next Call		Only for fixed line connection
Call Divert	Internal	Only for ISDN connection
	Fixed Line	Only for fixed line connection
	MSN1	MSN1 to MSN10 only with an ISDN connection
	MSN2	
	:	
	MSN10	
	IP1	IP1 to IP6 only with an ISDN connection
	IP2	
	:	
IP6		
Call Waiting		
Withhold # All Calls		
Busy on Busy		
Transfer (ECT)		
Ringback Off		



**Bluetooth**

→ page 46

Activation
Search for Headset
Search for Mobile
Search for Data Device
Known Devices
Own Device



**Additional Features**

Info Centre
Resource Directory

Screensavers
Caller Pictures
Sounds
Capacity



**Call Lists**

→ page 37

All Calls
Outgoing Calls
Accepted Calls
Missed Calls



**Messaging**

→ page 41

SMS
E-mail

New SMS
Incoming
Draft
Settings

Service Centres
Notification



**Answering Machine**

→ page 42

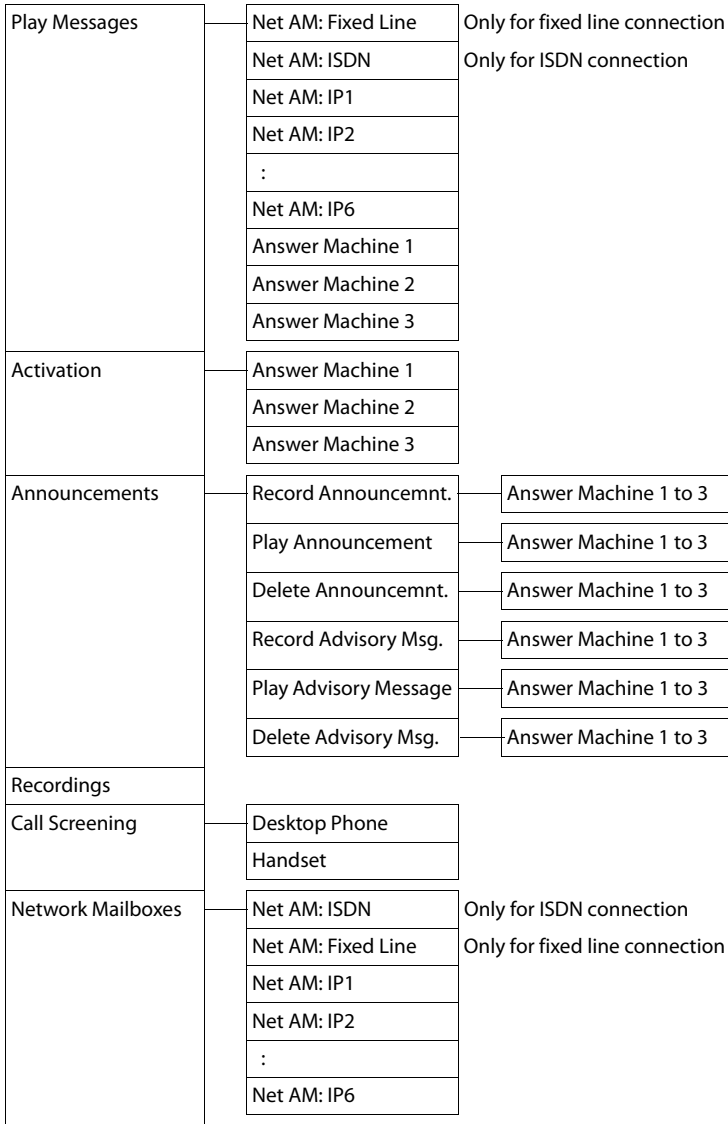

→ page 42

→ page 42

→ page 44

→ page 44

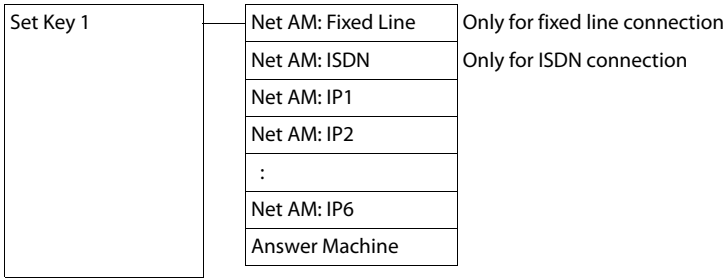

**Organizer**

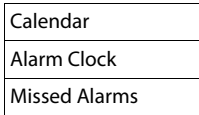

**Contacts**

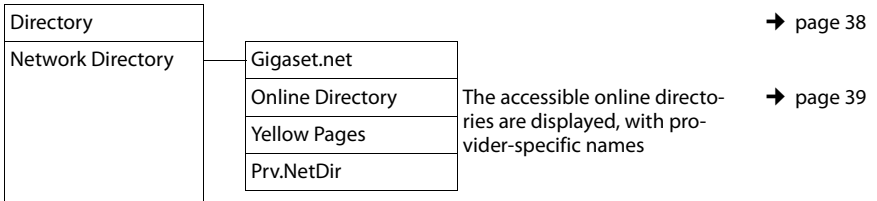

**Settings**

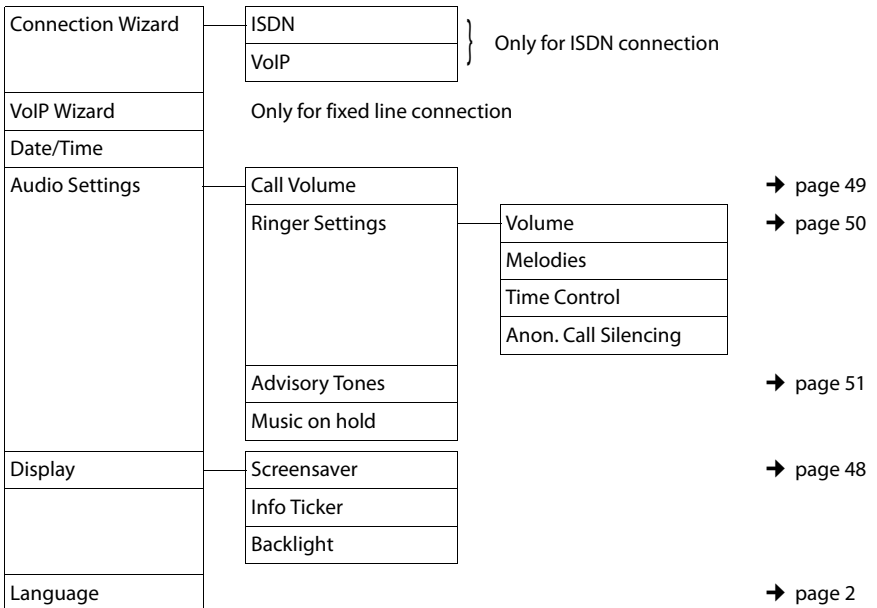

# Menu overview Gigaset DX800A all in one

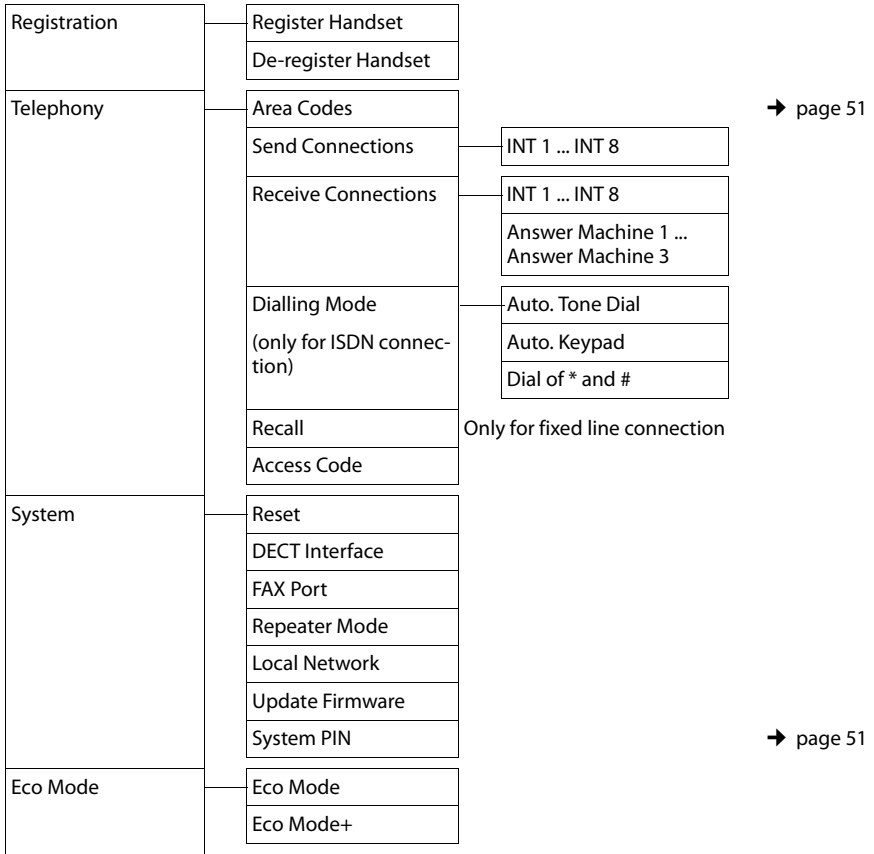

## Please note

This quick user guide only describes a small proportion of your base's functions. A detailed description of all functions in the menu tree can be found in the long user guide for your Gigaset DX800A all in one on the enclosed CD.

# Menu overview Gigaset DX600A ISDN

To open the main menu: press  when the base is in idle mode.

## Select Services

Next Call	Withhold Number
	Keypad Control
Call Divert	Internal
	MSN1
	MSN2
	:
	MSN10
Call Waiting	
Withhold # All Calls	
Busy on Busy	
Transfer (ECT)	
Ringback Off	

## Bluetooth

→ page 46

Activation
Search for Headset
Search for Mobile
Search for Data Device
Known Devices
Own Device

## Additional Features

Info Centre	
Resource Directory	Screensavers
	Caller Pictures
	Sounds
	Capacity



**Call Lists**

→ page 37

All Calls
Outgoing Calls
Accepted Calls
Missed Calls



**Messaging**

→ page 41

SMS	New SMS	Service Centres
	Incoming	
	Draft	
	Settings	
E-mail	Notification	



**Answering Machine**

→ page 42

Play Messages	Network Mailbox	
	Answer Machine 1	
	Answer Machine 2	
	Answer Machine 3	
Activation	Answer Machine 1	→ page 42
	Answer Machine 2	
	Answer Machine 3	
Announcements	Record Announcemnt.	Answer Machine 1 to 3
	Play Announcement	Answer Machine 1 to 3
	Delete Announcemnt.	Answer Machine 1 to 3
	Record Advisory Msg.	Answer Machine 1 to 3
	Play Advisory Message	Answer Machine 1 to 3
	Delete Advisory Msg.	Answer Machine 1 to 3
	Recordings	
Call Screening	Desktop Phone	
	Handset	→ page 44
Network Mailbox		
Set Key 1	Network Mailbox	
	Answering Machine	



**Organizer**

Calendar
Alarm Clock
Missed Alarms



**Contacts**

Directory
Network Directory

Online Directory
Yellow Pages
Prv.NetDir

The accessible online directories are displayed, with provider-specific names

- page 38
- page 39



**Settings**

ISDN Wizard
Date/Time
Audio Settings
Display
Language
Registration
Telephony

Call Volume
Ringer Settings
Advisory Tones
Music on hold

Volume
Melodies
Time Control
Anon. Call Silencing

- page 49
- page 50

Screensaver
Info Ticker
Backlight

- page 51

- page 48

Register Handset
De-register Handset

- page 2

Area Codes
Send Connections
Receive Connections
Dialling Mode
Access Code

INT 1 ... INT 8
-----------------

- page 51

INT 1 ... INT 8
Answer Machine 1 ...
Answer Machine 3

Auto. Tone Dial
Auto. Keypad
Dial of * and #



## Menu overview Gigaset DX600A ISDN

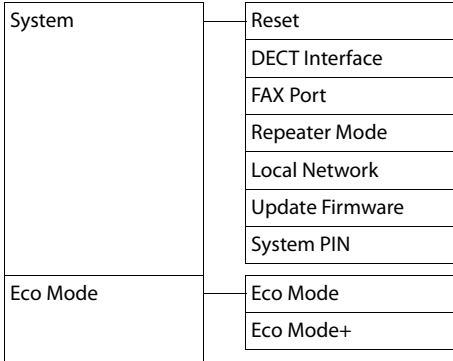

### **Please note**

This quick user guide only describes a small proportion of your base's functions. A detailed description of all functions in the menu tree can be found in the long user guide for your Gigaset DX600A ISDN on the enclosed CD.

# Menu overview Gigaset DL500A

---

To open the main menu: press  when the base is in idle mode.

## Select Services

Withhold No. Next Call	
Call Divert	Fixed Line
Call Waiting	
Withhold # All Calls	
Ringback Off	

## Bluetooth

→ page 46

Activation
Search for Headset
Search for Mobile
Search for Data Device
Known Devices
Own Device

## Additional Features

Info Centre	
Resource Directory	Screensavers
	Caller Pictures
	Sounds
	Capacity

## Call Lists

→ page 37

All Calls
Outgoing Calls
Accepted Calls
Missed Calls

# Menu overview Gigaset DL500A

## Messaging

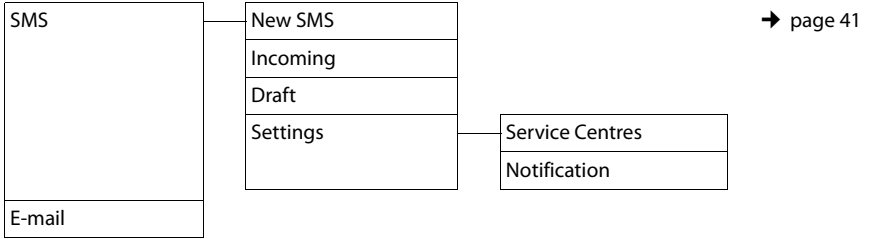

## Answering Machine

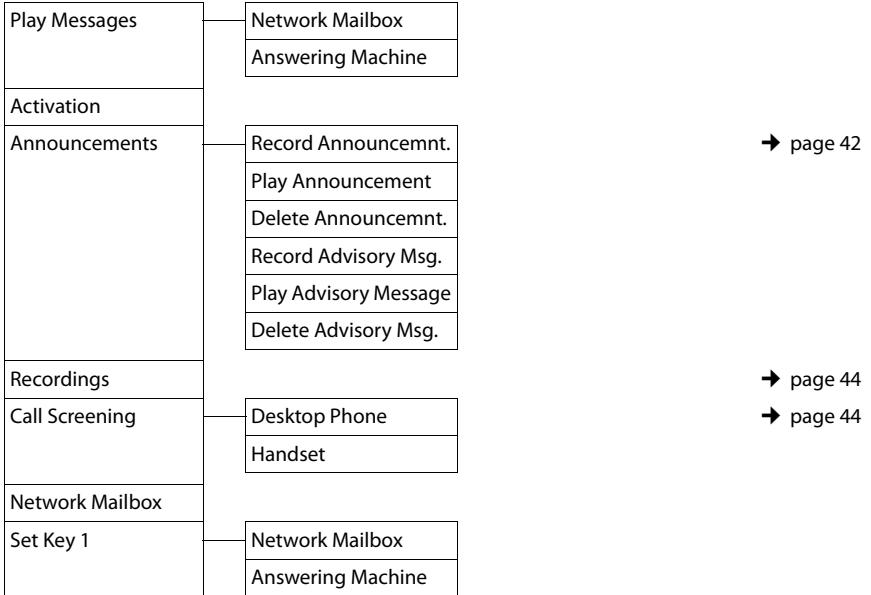

## Organizer

Calendar
Alarm Clock
Missed Alarms

## Contacts

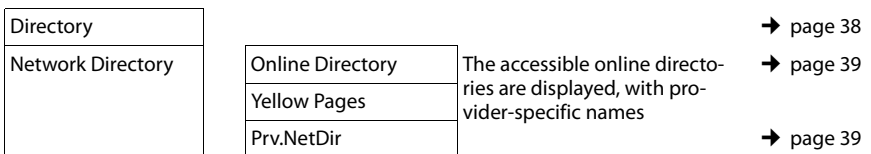



**Settings**

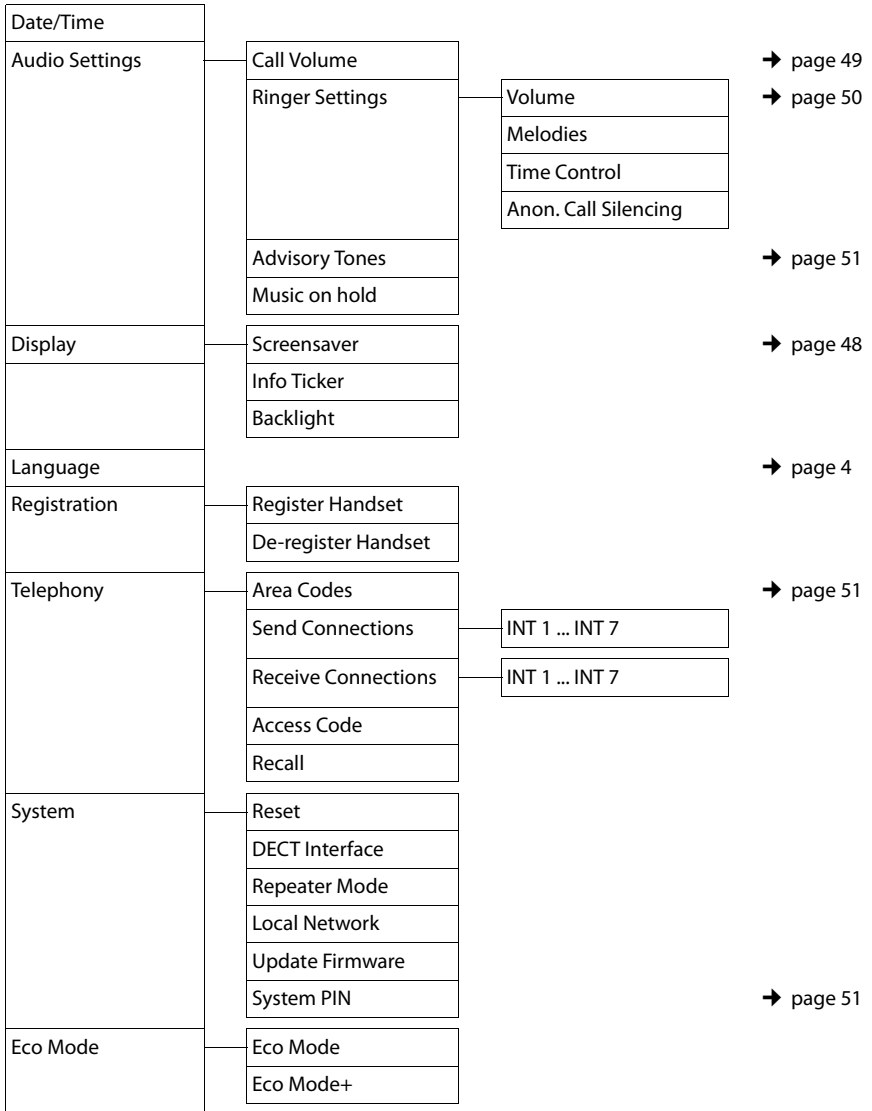

**Please note**

This quick user guide only describes a small proportion of your base's functions. A detailed description of all functions in the menu tree can be found in the long user guide for your Gigaset DL500A on the enclosed CD.

# Index

---

## A

- Activating
  - advisory tones ..... 51
  - answering machine ..... 42
  - answering machine
    - (remote operation)..... 45
  - two-way recording ..... 44
- Answering machine ..... 42
  - activating/deactivating ..... 42
  - deleting messages ..... 43
  - list ..... 37
  - playing back messages ..... 43
  - remote operation ..... 44
  - skipping back ..... 43
  - skipping forward ..... 43
- Area code
  - setting own area code ..... 51
- Assigning
  - function keys ..... 48
  - key ..... 48
  - number key ..... 48
- Authorisation ..... 53
- Auto configuration code ..... 20
- Automatic redial ..... 37

## B

- Base
  - connecting with router ..... 14
  - setting up ..... 9, 10
  - system PIN ..... 51
- Birthday, see Anniversary
- Bluetooth
  - registering devices ..... 46
  - setting own area code ..... 51
  - using GSM mobile phones ..... 47
- Bluetooth headset
  - using ..... 46
- Brightness
  - display backlight ..... 49

## C

- Call
  - accepting ..... 35
  - ending ..... 35
  - ending on headset ..... 35
  - internal ..... 35
  - picking up from answering machine .. 44
  - two-way recording ..... 44
- Call lists ..... 37
- Call screening during recording ..... 44
- Calling
  - from classified directory ..... 39
  - from online directory ..... 39
  - Gigaset.net ..... 40
  - internal ..... 35
- Changing
  - handsfree volume ..... 49
  - receiver volume ..... 49
  - ringer ..... 50
  - system PIN ..... 51
- CLIP picture ..... 38
- Connection wizard
  - starting (getting started) ..... 21
- Customer Care ..... 52
- Customer Service & Assistance ..... 52

## D

- Deactivating
  - advisory tones ..... 51
  - answering machine ..... 42
  - two-way recording ..... 44
- Deleting messages ..... 43
- Dialling
  - directory ..... 38
  - from online directory ..... 39
- Directory ..... 38
  - Gigaset.net ..... 40
  - saving entry ..... 38
  - searching for an entry ..... 39
  - sending entry/list to handset ..... 38
- Display
  - backlight ..... 49
  - screensaver ..... 48
  - setting ..... 48
- Display backlight
  - brightness of the display backlight ... 49
  - time control ..... 49
- Display keys
  - assigning ..... 48
- Documentation ..... 2

- E**
- Ending a call ..... 35
  - Entering user data (VoIP)
    - with handset ..... 24
  - External call
    - diverting to answering machine..... 44
- F**
- Firmware updates .....9
- G**
- General troubleshooting..... 53
  - Gigaset.net ..... 40
    - calling subscriber ..... 40
    - directory ..... 40
    - searching for subscribers ..... 40
  - Group call ..... 35
  - GSM connection
    - using via Bluetooth ..... 47
  - GSM mobile phones..... 47
- H**
- Handsfree volume..... 49
  - Headset
    - connecting (with cord) ..... 10
    - ending call ..... 35
  - Help ..... 53
- I**
- Icon
    - answering machine ..... 42
    - new message ..... 43
    - new SMS ..... 41
    - ringer ..... 50
  - Idle status
    - display in the (example) ..... 4
  - Incoming list (SMS) ..... 41
  - Installation wizard..... 16
  - Internal
    - call ..... 35
    - making calls ..... 35
  - ISDN wizard ..... 17
- L**
- Link2mobile ..... 47
  - Linking, see SMS
  - List
    - answering machine ..... 37
    - call lists ..... 37
    - missed calls ..... 37
    - network mailbox..... 37
    - SMS list ..... 37
- M**
- Making calls
    - accepting a call ..... 35
    - external ..... 35
    - internal ..... 35
  - Manual redial ..... 37
  - Medical equipment .....7
  - Message key
    - opening list ..... 41
    - opening lists..... 37
  - Messages
    - deleting..... 43
    - new message icon ..... 43
    - playing back..... 43
  - Microphone
    - muting..... 36
  - Missed call..... 37
  - Mobile phone
    - connecting (Bluetooth)..... 47
  - Muting the phone..... 36
- N**
- Number
    - saving in the directory..... 38
- O**
- Online directory
    - Gigaset.net ..... 40
  - Operating remotely ..... 44
  - Operation (setting up the phone)..... 8
- P**
- Package contents .....8
  - Phone, setting up .....8
  - Picture
    - caller..... 38
  - Playing back
    - message (answering machine) ..... 43
  - Power adapter .....7

## Index

### Q

Questions and answers ..... 53

### R

Receiver volume ..... 49

Recording

two-way recording ..... 44

Redial ..... 37

Registration password

VoIP account ..... 24

Ringer

changing ..... 50

setting volume ..... 50

time control ..... 50

Router

connecting base ..... 14

### S

Scope of delivery ..... 8

Screensaver ..... 48

Searching for subscribers on

Gigaset.net ..... 40

Sending

directory entry to handset ..... 38

Setting

date ..... 32, 33

screensaver ..... 48

time ..... 32, 33

Setting up the base ..... 9, 10

Signal tone, see Advisory tones

SMS ..... 41

deleting ..... 41

linked ..... 41

reading ..... 41

receiving ..... 41

SMS list ..... 37

Sound, see Ringer

### T

Text message, see SMS

Time control ..... 49

display backlight ..... 49

ringer ..... 50

### U

User guide ..... 2

Using handsfree mode ..... 36

### V

VIP (directory entry) ..... 38

VoIP

configuring account (first) ..... 24

loading provider data ..... 23

starting connection wizard ..... 20

VoIP provider

downloading data ..... 23

selecting ..... 23

VoIP user data

entering (connection wizard) ..... 24

Volume

handsfree ..... 49

receiver ..... 49

receiver/handsfree ..... 49

ringer ..... 50

setting ..... 50

### W

Warning tone, see Advisory tones

Writing (SMS) ..... 41

## Insert strip – labelling function keys

### On the telephone:

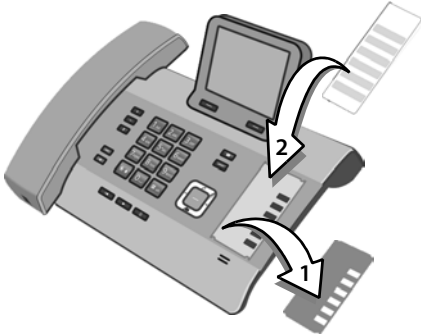

- ▶ Remove the protective film from the indented area next to the function keys (1).
- ▶ Place the insert strip into the indented area (2) next to the function keys. Slide it under the plastic tabs at the edge of the indented area.

### Indented area on the housing including function keys

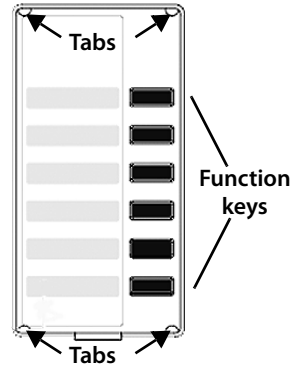

- ▶ Place the protective film back into the indented area so that the function keys fit into the recesses of the protective film. Then slide the protective film under the plastic tabs.

To find the insertstrips in original please see as well the back page of your cover.

A file containing additional insert strips that you can also directly edit on your PC is provided on the enclosed CD.



Issued by

Gigaset Communications GmbH  
Frankenstr. 2a, D-46395 Bocholt

© Gigaset Communications GmbH 2011

All rights reserved. Subject to availability.

Rights of modification reserved.

[www.gigaset.com](http://www.gigaset.com)



A31008- N3101- L101- 2- 7643