

Gigaset

SL910-SL910A

Congratulations

By purchasing a Gigaset, you have chosen a brand that is fully committed to sustainability. This product's packaging is eco-friendly!

To learn more, visit www.gigaset.com.



GIGASET. INSPIRING CONVERSATION.
MADE IN GERMANY

Gigaset SL910/SL910A – with the special "touch"

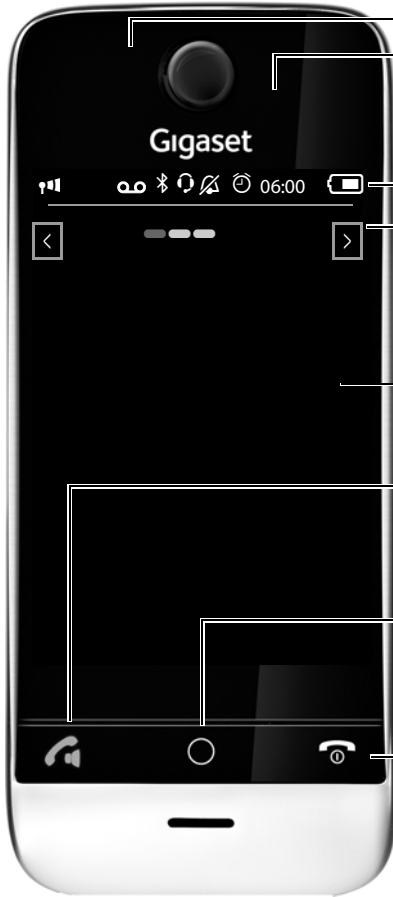

Message LED (→ page 20)

Proximity sensor (→ page 24)

Touchscreen/display

Status bar (→ page 22)

Icons (→ page 72) show the telephone's current settings and operating status. Touch the status bar to open the → status page, page 22.

Navigation area

Page position marker ,
Change page .

Idle displays or menu (→ page 17)

Handset keys

Talk key

Press **briefly**: Dial displayed number, accept call, switch between earpiece and handsfree mode, open the redial list
Press and **hold**: assign a line

Menu key

Press **briefly**: open main menus (→ page 23)
Press and **hold**: activate/deactivate (→ page 24) keypad and display lock

End call/end key

Press **briefly**: end call/paging, reject internal call, switch off ring tone for external call, return to idle status
Press and **hold**: switch handset on/off

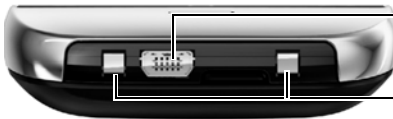

Mini USB connection socket

Connect wire-bound headset or handset to your PC (Gigaset QuickSync)

Charging contacts

Gigaset SL910/SL910A – with the special "touch"

The **base of the Gigaset SL910/SL910A** is supplied in **two variants**. The functionality and features of both variants are **identical**.

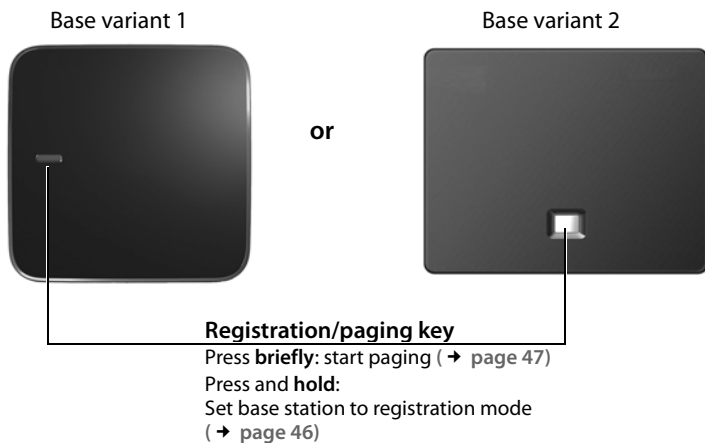

Contents

| | |
|---|----|
| Gigaset SL910/SL910A – with the special "touch" | 1 |
| Safety precautions | 4 |
| Getting started | 5 |
| Understanding the operating steps | 16 |
| Display pages | 17 |
| Using the telephone | 24 |
| Making calls | 29 |
| Changing phone settings | 34 |
| ECO DECT | 39 |
| Answering machine (Gigaset SL910A) | 41 |
| Network mailbox | 45 |
| Multiple handsets | 46 |
| Bluetooth devices | 50 |
| Contacts (address book) | 53 |
| Calls list | 58 |
| Calendar | 59 |
| Alarm | 61 |
| Baby phone call | 62 |
| Screensaver, caller pictures and sounds | 63 |
| SMS (text messages) | 64 |
| Synchronising with your PC (Gigaset QuickSync) | 68 |
| Connecting the base station to the PABX | 69 |
| Display icons | 71 |
| Setting options | 73 |
| Customer service & product warranty – Australia and New Zealand | 78 |
| Environment | 82 |
| Appendix | 83 |
| Accessories | 86 |
| Open Source software | 89 |
| Index | 97 |

Safety precautions

Warning

Read the safety precautions and the user guide before use.
Explain their content and the potential hazards associated with using the device to your children.



Use only the power adapter indicated on the device.



Use only **rechargeable batteries** that correspond to the **specification** (see "Technical Data"). Never use a conventional (non-rechargeable) battery or other battery types as this could result in significant health risks and personal injury. Rechargeable batteries, which are noticeably damaged, must be replaced.



Using your telephone may affect nearby medical equipment. Be aware of the technical conditions in your particular environment, e.g., doctor's surgery.
If you use a medical device (e.g., a pacemaker), please contact the device manufacturer. They will be able to advise you regarding the susceptibility of the device to external sources of high frequency energy (for the specifications of your Gigaset product see "Technical Data").



Do not hold the rear of the handset to your ear when it is ringing or when speaker mode is activated. Otherwise you risk serious and permanent damage to your hearing.
Your Gigaset is compatible with the majority of digital hearing aids on the market. However, perfect function with all hearing aids cannot be guaranteed.
The phone may cause interference in analogue hearing aids (humming or whistling) or cause them to overload. If you require assistance, please contact the hearing aid supplier.



The devices are not splashproof. For this reason do not install them in a damp environment such as bathrooms or shower rooms.



Do not use the devices in environments with a potential explosion hazard (e.g., paint shops).



If you give your Gigaset to a third party, make sure you also give them the user guide.



Remove faulty devices from use or have them repaired by our Service team, as these could interfere with other wireless services.

Please note

- ◆ The device cannot be used in the event of a power failure. It is also **not** possible to transmit **emergency calls**.
- ◆ Emergency numbers cannot be dialled if the keypad lock is activated!

Getting started

Checking the package contents

- ◆ One **base** Gigaset **SL910/SL910A** (variant 1 or variant 2)
- ◆ One base cover stand (only with base variant 1)
- ◆ One power adapter for the base
- ◆ One phone cable (flattened)
- ◆ One Gigaset **handset**
- ◆ One battery cover (rear cover for the handset)
- ◆ One battery
- ◆ One **charger cradle**
- ◆ One power adapter for the charger cradle
- ◆ One poster, one user guide

Installing the base and charger cradle

The base and charger cradle are designed for use in dry rooms in a temperature range of +5°C to +45°C.

- ▶ Set up the base on a level, non-slip surface at a central point in the building or mount the base on the wall (→ [page 7](#)).

Please note

Pay attention to the range of the base. In buildings this is up to 50 m, outdoors up to 300 m. The range is reduced when ECO DECT (→ [page 39](#)) is activated.

The phone's feet do not usually leave any marks on surfaces. However, due to the multitude of different varnishes and polishes used on today's furnishings, the occurrence of marks on the surfaces cannot be completely ruled out.

Please note:

- ◆ Never expose the telephone to the effects of heat sources, direct sunlight or other electrical devices.
- ◆ Protect your Gigaset from moisture, dust, corrosive liquids and fumes.

Connecting the base with the phone network and the mains power supply

Base variant 1

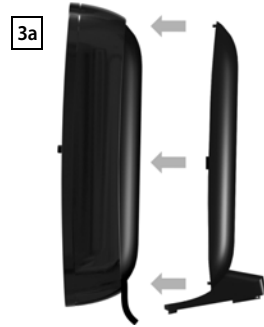
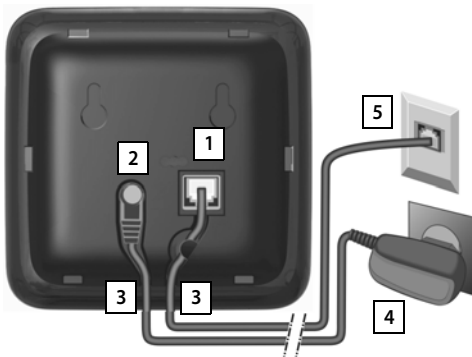

Base variant 2

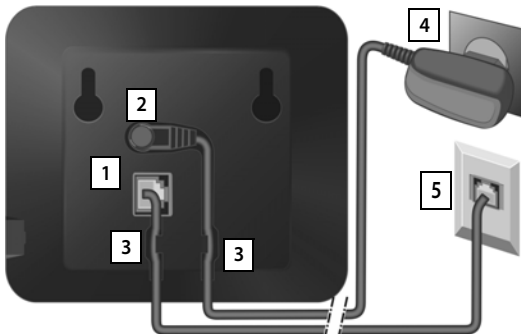

- ▶ Insert the phone cable (cable slightly flattened) into the right/lower connection socket **1** at the rear of the base until it clicks into place.
- ▶ Insert the power cable for the power adapter into the left/upper connection socket **2**.
- ▶ Insert both cables into the appropriate cable channels **3**.
- ▶ Base variant 1: Place the cover in the notches on the back of the base and click into place **3a** (not if mounting on the wall).
- ▶ First connect the power adapter **4** and then connect the telephone jack **5**

Please note:

- ◆ The power adapter must **always be connected**, as the phone will not operate without a power supply.
- ◆ Use only the power adapter and phone cord **supplied**. Pin connections on telephone cables can vary (pin connections, → page 85).

Wall mounting the base (optional)

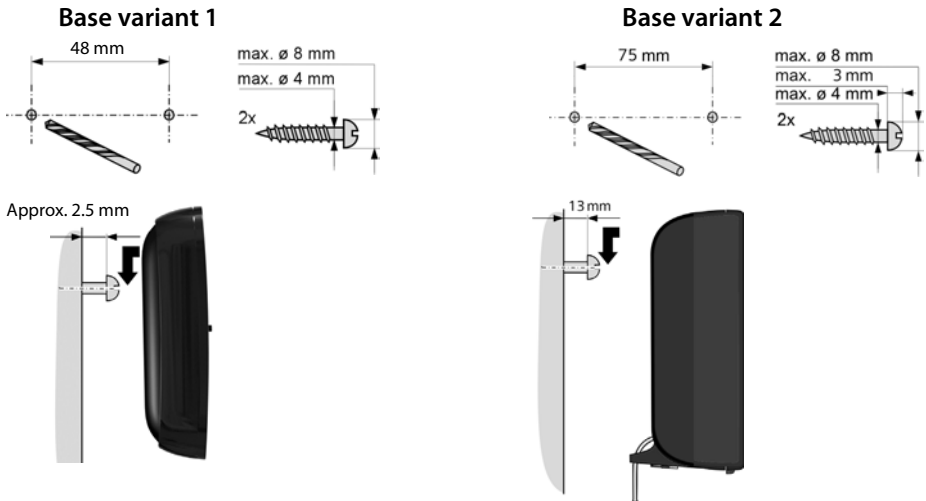

Connecting the charger cradle

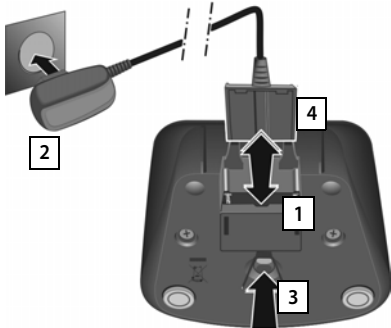

- ▶ Connect the flat plug to the power adapter **1**.
- ▶ Plug the power adapter into the plug socket **2**.

If you have to remove the plug from the charger cradle again:

- ▶ First disconnect the power adapter from the mains power supply.
- ▶ Then press the release button **3** and disconnect the plug **4**.

Setting up the handset for use

The handset's display and keys are covered with a protective film. **Please remove the protective film.**

Handsets contained in the package have already been registered to the base. If, however, a handset has not been registered (display "**Handset not registered to any base**"), please register it manually (→ page 46).



Getting started

Caution

Please do **not** use any touchscreen styli to operate the handset.

Do not use protective cover/film from other manufacturers. This can restrict operability of your handset.

Inserting the battery and closing the battery cover

Caution

Use only rechargeable batteries (→ [page 84](#)) recommended by Gigaset Communications GmbH, as doing otherwise could result in significant health risks and personal injury. For example, the outer casing of the battery could be destroyed or the battery could explode. The phone could also malfunction or be damaged as a result of using batteries that are not of the recommended type.

- ▶ First, insert battery with the contact surface facing down **1**.
- ▶ Then press the battery downwards **2** until it clicks into place.

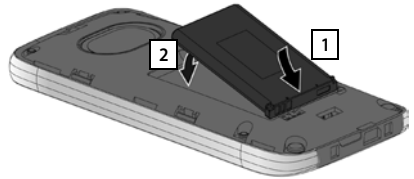

- ▶ First, align the protrusions on the side of the battery cover with the notches on the inside of the casing.
- ▶ Then press the cover until it clicks into place.

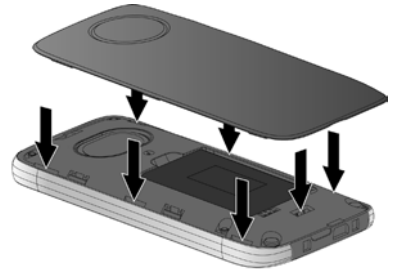

To **reopen the battery cover** to replace the battery:

- ▶ Insert your fingernail into the notch on the bottom of the battery cover and pull the battery cover upwards.

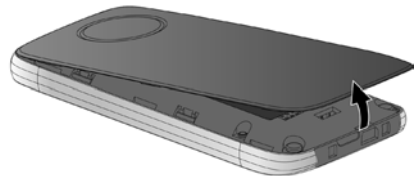

Charging the battery

The battery is supplied with a partial charge. Please charge it completely before use.

- ▶ Charge the handset in the charger cradle for **5 hours**.



Please note

- ◆ The handset must only be placed in the designated charger cradle.
- ◆ The battery is also charged if the handset is connected via a USB connection to a PC with a power supply of 500 mA
- ◆ The battery may heat up during charging. This is not dangerous.
- ◆ After a time, the charge capacity of the battery will decrease for technical reasons.

Setting up the base and handset — installation wizard

Caution

If you select the **Use with restrictions** option, important functions on your phone will not be available. If you want to complete the firmware update at a later date, you must first reset the base; this action will reset all the base settings and all handsets will be de-registered.

To reset the base: ▶ Remove the power cable from the base ▶ Press and hold the registration/paging key on the base and at the same time reconnect the power cable to the base
▶ Press and hold the registration/paging key until it begins to flash (approx. 10 seconds).

Once the handset has been registered again successfully, the message above is displayed again.

Once the battery has been inserted, the time and date symbols flash. The installation wizard starts automatically as soon as you touch one of the flashing symbols. It helps you to configure the following key settings on the handset and base. These keys are required for operation:

- ◆ Time and date
- ◆ Display language
- ◆ Country in which the phone will be used
- ◆ Your own area code

Getting started

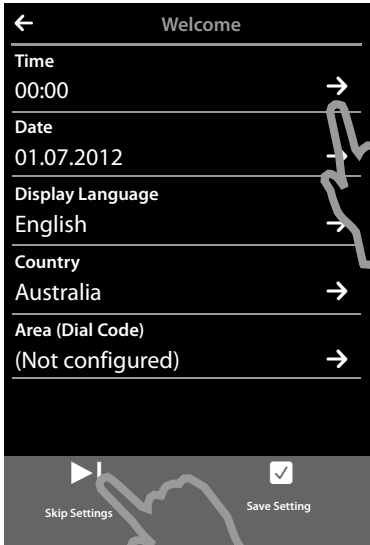

If you want to adjust the settings at a later date:

- ▶ Touch the [▶ **Skip Settings**] option at the bottom of the display.

The handset then switches to idle status.

You can configure the settings at any time using the **Settings** menu on your handset.

If you want to configure the settings:

- ▶ Touch the [➔] icon next to the time to set the time.

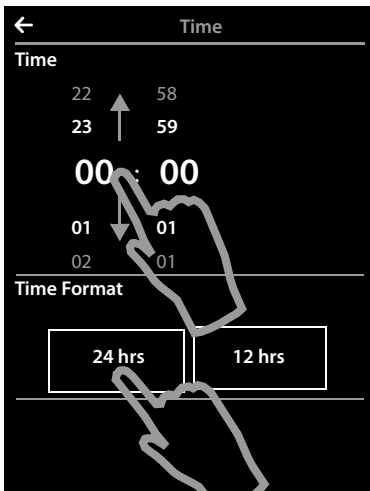

- ▶ Use the left-hand number wheel to select the current hour by touching the number wheel with a finger and moving it upwards or downwards. The number wheel will follow your movements.
- ▶ Operate the right-hand number wheel in the same way to select the minutes.
- ▶ Specify whether you wish the time to be displayed in **12 hrs** or **24 hrs** mode. To do this, touch the corresponding area under **Time Format**. The current setting is highlighted.
- ▶ Touch the [←] icon (at the top left of the display) to save the settings and return to the **Welcome** page.

Note: If you set the **12 hrs** mode, **am/pm** is shown next to the number wheels.



- ▶ Touch the [➔] icon next to **Date** to set the date.





- ▶ Use the three number wheels to set the current date. The procedure is the same as for setting the time.

The current mode for displaying the date is displayed under **Date Order** (here: **Day Month Year**). If you want to change the mode:

- ▶ Touch the  icon.



The date order setting is indicated by .

- ▶ Touch the  icon to switch between **Day Month Year**/**Month Day Year**
- ▶ Keep touching the  icon until the **Welcome** page appears.



The current language is displayed under **Display Language**.

If you want to change the setting:

- ▶ Touch the  icon next to the displayed language.

Getting started

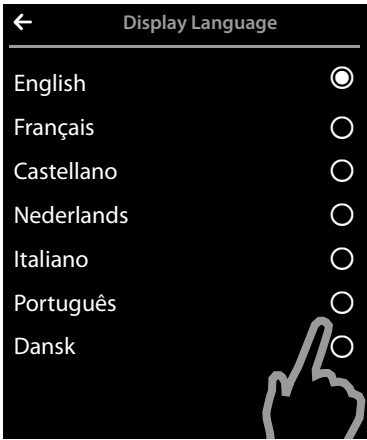

This brings up a list containing all the available languages.

The current language is marked with .

► Touch the  icon next to the required language.

If your language is not displayed, the list may be "longer" than the display. You must then scroll through the list.

► To do this, put a finger on the display and move it slowly upwards.

The lower section of the list is then displayed and you can select a language.

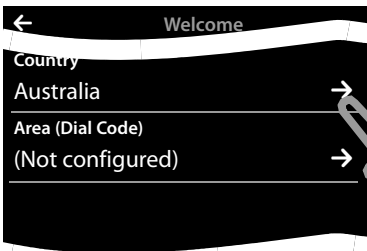

Under **Country** enter the country in which you will operate the phone and for which it is authorised. If the setting is not correct:

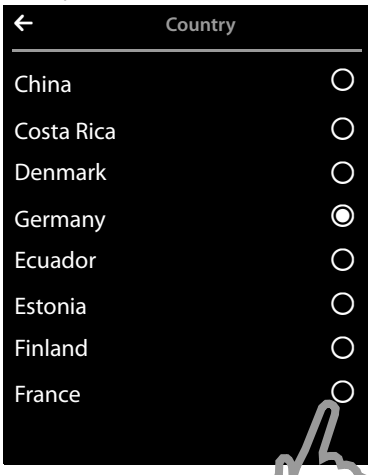

► Touch the  icon next to **Country**.

(Example)



A list of countries is displayed.

The current country is marked with .

► If necessary, as mentioned before, you must scroll through the list to find your country. Touch the  icon next to your country. The  mark moves to this country.

► Touch the  icon to save the change and to return to the **Welcome** page.

Please note

If you have selected **Other Country** instead of a country, the **Welcome** page will also show the **Country (Dial Code)** entry.

- ▶ Touch  next to **Country (Dial Code)** and enter the **International Prefix** and **International Area Code** for the international country code, as described below for the area (dial code).

Proceed as described below.

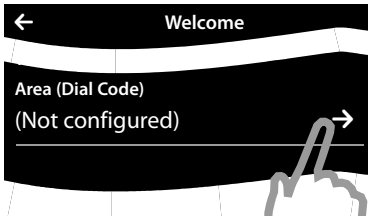



Finally, you have to enter your area code:

- ▶ Next to **Area (Dial Code)** touch 



The **Local Prefix** is the country-specific area code that precedes the **Local Area Code** when the country code is not dialled. In Australia, the "0" **Local Area Code** is then e.g., 3 for Melbourne.

- ▶ On the keypad displayed, enter the **Local Prefix** for your country in the first field (maximum 4 characters, "0" in the example). The field is already populated for the selected country.
- ▶ Briefly touch the second input field and enter the **Local Area Code** (maximum 8 characters, "3" in the example)
You can correct incorrect entries using .
- ▶ Touch  after entering the numbers to complete the entry.

Getting started

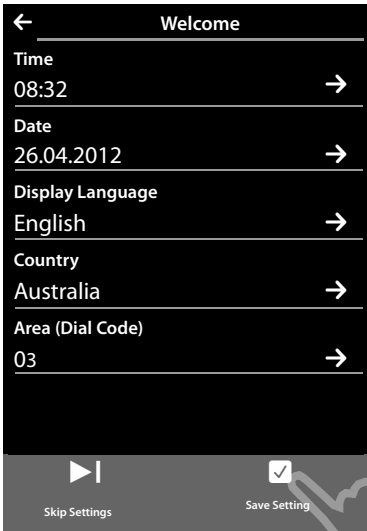

The **Welcome** page is displayed again.

- ▶ Touch the [**Save Setting**] option to save your settings.

Once you have configured all the necessary settings, your handset switches to idle status.

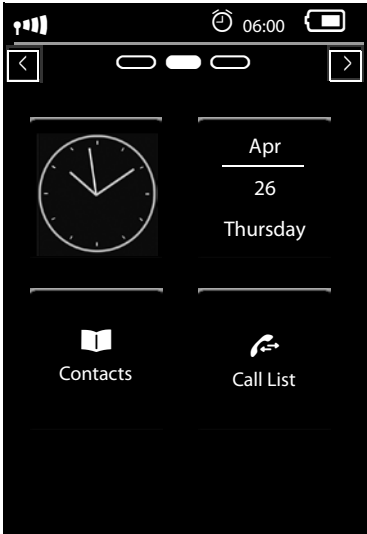

Your phone is now ready for use.

What would you like to do next?

After successfully setting up the phone, you can make calls straight away, customise your Gigaset according to your requirements or firstly familiarise yourself with the operating features (→ [Using the telephone](#), → [page 24](#)).

Creating your own idle display page

Use your (own) configurable idle display page to collate important functions and phone numbers that you want to start or dial via the touch display (→ [page 18](#)).

Synchronising with contacts in Google or Outlook

Synchronise your handset's Contacts list using your PC and our Gigaset QuickSync software (→ [page 68](#)).

For the free download and more information, see www.gigaset.com/gigaset910.

Setting ring tones and silent alert

Assign specific tunes to internal and external calls, reminders, wake-up calls and to certain callers. Use time control for calls (→ [page 35](#)).

Setting up the answering machine

Record your own announcements and set your recording parameters (→ [page 41](#)).

Registering existing Gigaset handsets to the base

Continue using these handsets to make calls from your new base. Transfer Contacts entries from these handsets to your new handset (→ [page 46](#)/ → [page 55](#)).

For further information see the user guides for these handsets.

Making ECO DECT settings

Reduce the transmission power (emissions) of your phone (→ [page 39](#)).

Download your personal ring tones and images to your handset.

Connect your handset to your PC via Bluetooth/USB and download ring tones and images to your handset with the help of our **Gigaset QuickSync** software (→ [page 50](#)/ → [page 68](#)).

For the free download and more information, see www.gigaset.com/gigaset910.

Operating the telephone on a PABX

If necessary, adjust pause times and dialling modes on the PABX (→ [page 69](#)).

If you have any questions about using your phone, please read the tips on troubleshooting (→ [page 80](#)) or contact our Service team (→ [page 78](#)).

Understanding the operating steps

The following images are used in the operating instructions:

Example 1:

Menu key  ▶ [ Room Monitor]

- ▶ Press the  menu key in idle status.
The **Applications** menu page is displayed.

- ▶ Touch the  icon.

Example 2:

Menu key  ▶ Menu page **Settings** ▶ [ Language + Location] ▶ **Area (Dial Code)**

- ▶ Press the  menu key.
- ▶ Drag your finger horizontally across the display to switch to the menu page **Settings**.

- ▶ Touch the  icon.

- ▶ Touch the **Area (Dial Code)** menu entry or the  icon next to the menu entry.



Display pages

Idle display

The idle display comprises three pages:

- ◆ The dial page (see below)
- ◆ The configurable page (→ page 18)
- ◆ The messages page (→ page 20)

Switch between the menu pages:

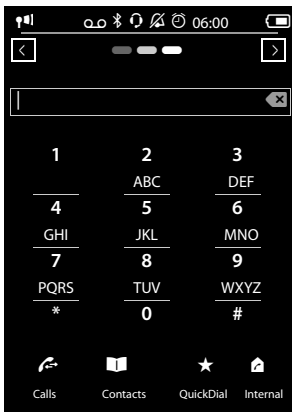

- ◆ Drag your finger horizontally across the display or
- ◆ In the navigation area, touch  or .

Dial page



Number field

Displays the numbers entered.

Touch  **briefly**: delete the last number entered
Press and **hold** : delete all numbers



Keypad



Numerical keypad for entering phone numbers. When you touch a number, it is displayed in the number field.

Options bar (→ page 25)

To dial from call lists, Contacts and speed dial list, as well as internal calls.



Configuring the keyboard/keypad individually

You can change the appearance and behaviour of the keypad shown in the display according to your needs. The settings do not correspond to the handset keys (  .

- ▶ Menu key  ▶ Menu page **Settings** ▶ [ **Display and Keypad**] ▶ Scroll to **Keypad**.

[ **Display and Keypad**] submenu:

You can configure the following:

- ◆ **Key Tones**: Every time you touch a digit, a confirmation tone is audible.
- ◆ **Key Vibration**: Every time you touch a digit on the keypad, the handset vibrates.
- ◆ **Keypad with R/P**: To insert
 - a line interruption (flash, R): **Press and hold** ().
 - a dialling pause (P): **Press and hold** (.
- ◆ **Keypad w. Letters**: For dialling with letters — sometimes used for entering service numbers, for example.

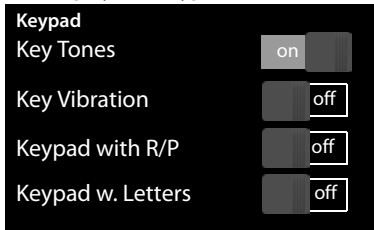

Display pages

- ▶ You can use the switch on the right to activate or deactivate the relevant function directly. Change (activate/deactivate) switching: **Briefly** touch the switch.

Configurable (personal) page

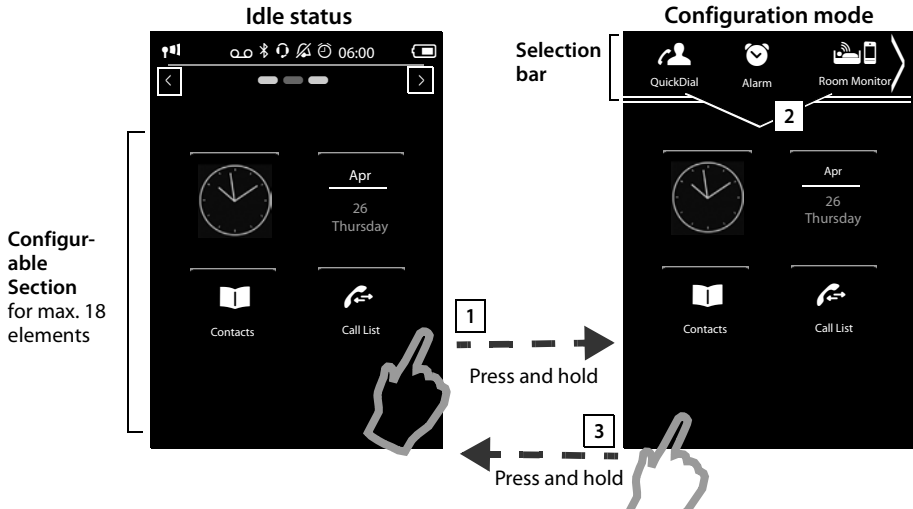

You can **customise the configurable page** to suit your needs. Bring together the important applications and numbers, which you can start up or call directly from idle status with a single touch. By default, the date and time are displayed and quick access to call lists and contacts is possible.



1 Starting the configuration process

- ▶ Switch to the configurable page.
- ▶ Press and **hold** (approx. 2 seconds) any position on the configurable area on the display.

2 Compile application/function

A pick list with the available functions/applications is displayed at the top edge of the display. The  (arrow) icon to the right of the pick list shows that you can move the pick list horizontally to display additional selection options. To do this, place a finger on the pick list and move it in the opposite direction to the  arrow. Additional functions are displayed.

- ▶ **Insert application/function:** Drag the function/application using drag&drop from the selection list into the configurable area.

Please note

With the exception of QuickDial, each function can exist in the configurable area only once. You can collate a maximum of 18 functions, applications or QuickDials.

- ▶ **Remove application/function:** Drag the icon for the application/function back to the selection list using drag&drop.

Please note

A QuickDial is deleted. The related entry in Contacts remains unchanged. The settings for all other functions (e.g., wake-up time) remain unchanged.

3 Completing the configuration process

- ▶ **Press and hold** any position on the configurable area on the display, or
- ▶ **Press**  briefly.

The settings are saved.

You can now start/select your desired applications/telephone numbers by briefly touching the corresponding icon.

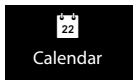
Selectable applications and functions

Calendar

Date display
Open calendar (→ page 59)



Time

Time display
Set time (→ page 10)

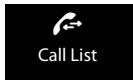

Call List

Open call lists (→ page 58)



Room Monitor

Set baby phone call
(→ page 62)



Alarm

Set alarm clock (→ page 61)

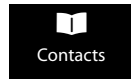

Contacts

Open Contacts (→ page 53)



QuickDial

Speed dial (→ page 57):
Dialling a number







Write Message

Write an SMS (→ page 64)

Messages page

You can use the messages page to access the following message lists:

- ◆  Answering machine list (Gigaset SL910A only)
- ◆  Network mailbox, if your network provider supports this function and the number of the network mailbox is stored in your telephone
- ◆  SMS inbox
- ◆  Missed calls list (→ [Calls list, page 58](#))
- ◆  Missed appointments list (→ [page 60](#))

Messages page (example)

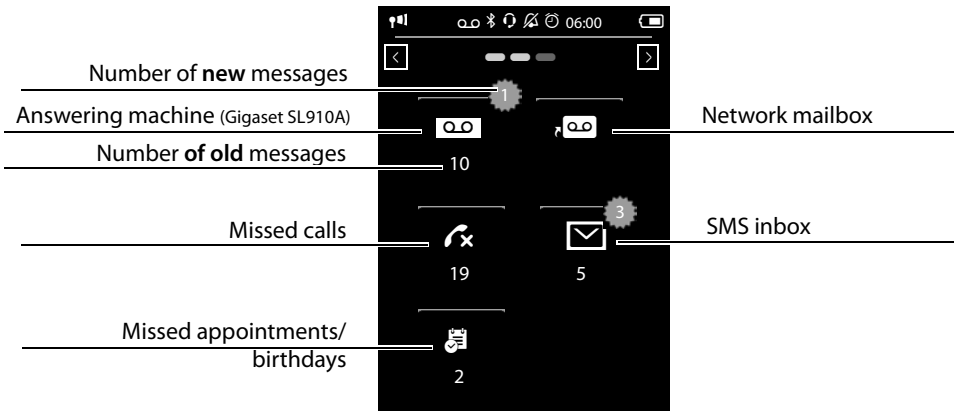

The missed calls list and answering machine list (Gigaset SL910A) are always displayed, even if the lists are empty. The icon for the network mailbox is displayed, provided the number is stored in the telephone. The other lists are only displayed if they contain messages.



- ▶ Touch an icon to open the corresponding list.

Exception: If you touch the icon for the **network mailbox**, your telephone will dial the number for the network mailbox (→ [page 45](#)). No list will open on the display.

Message pop-up

An advisory tone sounds as soon as a **new entry** arrives in a list. If activated (→ [page 35](#)) the message LED on the left next to the earpiece also flashes and the message pop-up is displayed. The pop-up may partly conceal the dial page and the configurable page. New messages are displayed on the message page as described above.

The number of new messages in each list is displayed beneath the icons.

- ▶ **Close the pop-up:** Touch  (top right).
- ▶ **Open the list:** Touch the corresponding list icon.
If the network mailbox has been configured: Touching  opens the message page with the corresponding icons rather than a list.

If there are more new messages in other lists, the display will show the message page (but not the pop-up) when you return to the idle display.

The messages LED flashes (if activated, → [page 35](#)) until you have opened all new messages.



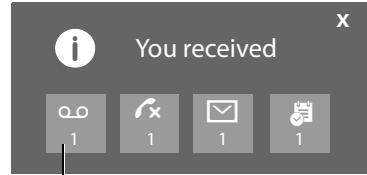



Messages pop-up (example):



Answering machine (Gigaset SL910A depending on the base) and/or network mailbox

List entry

The following information is displayed in the list entries:

- ◆ The list type (in the header)
- ◆ Icon for the type of entry.
 - **Call list:**  (Missed),  (Accepted),  (Outgoing),  (call on answering machine, Gigaset SL910A only)
 - **SMS list:**  (unread)  (read)
 - **Answering machine list:**  (message on the answering machine)

The icon is red for new (unread) entries.

- ◆ Caller's number. If the caller's number is stored in Contacts, the caller's name and number type (**Home, Office, Mobile**) is displayed instead. For missed calls, the number of calls from this number is also shown in square brackets.
- ◆ Date and time of call (if set).

You have the following options:

- ▶ **Call back a caller:** Briefly touch the list entry.
- ▶ **Open the detail view:** Next to the entry, touch 

The display shows all the available information. The message is played back in the answering machine list. The SMS text is displayed in the SMS incoming message list.

In the detail view, you can delete the entry or add the number of the entry to Contacts (→ [page 56](#)).

Call list (example):

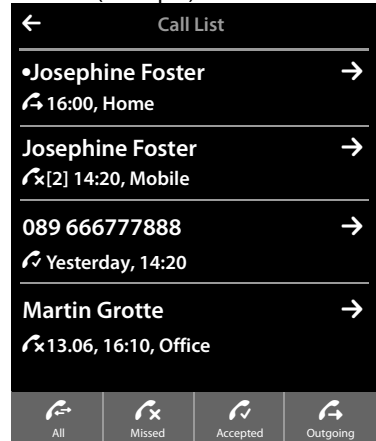



Display pages

Please note

If you press the  key after you have opened a list, the number for the entry marked by a green dot will be dialled immediately.

Deleting lists

You can delete the entire contents of the individual lists:

- ▶ Menu key  Menu page **Settings** ▶ [ **System**]
 - ▶ (Scroll down if necessary) **Clean-up List**
- ▶ Touch  next to the list to be deleted ▶ Confirm with **Yes**.



Status bar and status page

The top line in the idle display is called the status bar. It shows the phone's current settings and operating state (meaning of the icons, → [page 72](#)).



Status page

You can use the status page to change the settings of the adjacent components.

- ▶ Briefly touch the status bar to open the status page.
- ▶ Briefly touch the switch next to a component to activate/deactivate it ( = activated).
- ▶ If you touch a list entry, e.g., **Alarm**, a page (the submenu) will open where you can adjust the component's settings.
- ▶ Touch the **Show Service Info** button to display the service information for your handset. You may need the service information when you contact our hotline.
- ▶ Press  or touch  in the top display line to return to the idle display.

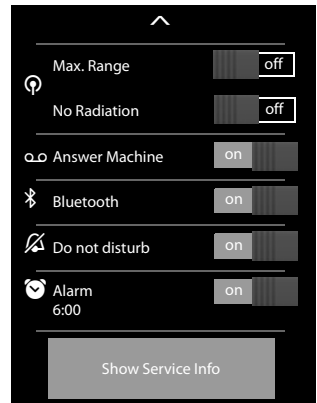

Please note

If multiple handsets are registered, the internal number of the handset is displayed in the display status bar (e.g., **INT 1**)

Menu pages *

Menu page "Applications"

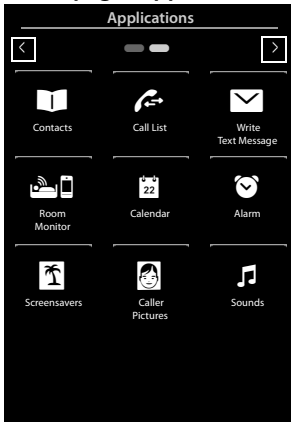

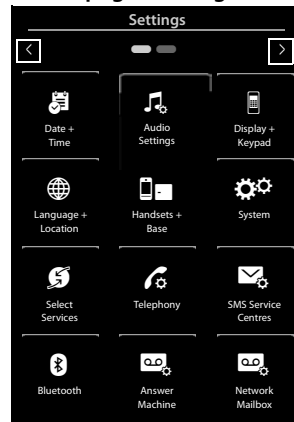

Menu page "Settings"



Switching from an idle display to the Applications menu page:

- ▶ Briefly press the  menu key

Switch between the menu pages:

- ◆ Drag your finger horizontally across the display or
- ◆ In the navigation area, touch  or .



Returning to the idle display from anywhere in the menu:

- ▶ Press the  key briefly.

*Please note: Applications/settings that are currently unavailable (e.g., because the handset is outside the range of the base) will not be displayed.

Using the telephone

Switching the handset on/off

- ▶ **To switch off:** In idle status, **press and hold** the end call key .
 - ▶ **To switch on:**
 - Press and **hold** the end call key .
- Or:
- Place the handset in the charger cradle. It will switch on after approximately 35 seconds.

Returning to idle status

- ▶ **Briefly** press end call key .
- Or:
- ▶ If you do not press any key and do not touch the display, the display **automatically** reverts to idle status after approximately three minutes.

Keypad and display lock

The keypad and display lock prevents the phone being operated unintentionally. If you touch the display when the lock is activated, nothing happens. A corresponding message will appear if you press a key.

Activating/deactivating the keypad and display lock

When the handset is in idle status:

- ▶ Press and **hold** the  menu key to activate or deactivate the lock.

If a call is signalled on the handset, the keypad/display lock automatically deactivates and you can accept the call. The key and display lock activates again once the call has finished.

Please note

When the keypad lock is active, you cannot call emergency numbers.

Automatic display lock

During a call, the display is automatically locked with the aid of a proximity sensor if you hold the handset to your ear (display backlight disappears). This lock is deactivated again when you remove the handset from your ear.

The sensor is located on the right next to the earpiece (→ [page 1](#)). If you cover it accidentally with your finger during a call, the display will also be locked.

Operating the touchscreen

You operate the handset mainly via the display.

Icons, list entries, switches and selection areas shown on the display are sensitive areas. You can set up and activate functions, enter or dial phone numbers and navigate between the various display screens (pages) by touching these areas and dragging them across the display.

Selecting functions/list entries

Touch a list entry or the corresponding icon to select the list item (Contacts, submenu, call lists) or to activate/deactivate a function.

Scrolling in lists and menus (scrolling vertically)

- ▶ Drag the display in a vertical direction.

If there are more list entries than can be displayed all at once, a drop shadow at the bottom or top edge of the display indicates the direction in which you have to scroll to view more of the list.

As soon as you scroll in a list, a scroll bar appears on the right side of the display. This shows the size and position of the visible section of the list.



Scrolling through lists is not continuous, i.e., you have to scroll back to return to the top from the end of the list.

Options, option slider

Many displays have an **options bar** at the bottom. This displays all the actions that you can apply in the current context (icons used, → [page 71](#)). There are single-row (e.g., in Contacts) and double-row option sliders (e.g., during an external call).

- ▶ Touch an option to execute the corresponding action.

If there are more options available than can be displayed in an options bar at the same time, these additional options are provided as follows:

- ◆ With a one-line options bar, the arrow on the right  and/or left  next to the options (see image) indicates that further options are available.
 - ▶ Touch the option slider and drag it in the direction of the arrow in order to move the additional options into the display (scroll horizontally).

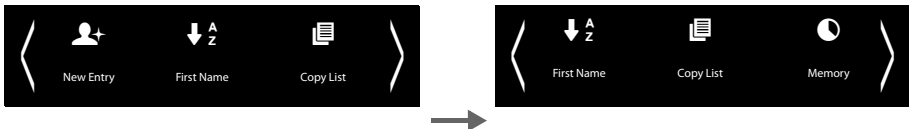

- ◆ With a two-row option slider, the icon  below the option slider indicates that further options are available.

Using the telephone

- ▶ Touch  to display a further option slider that conceals the original option slider.

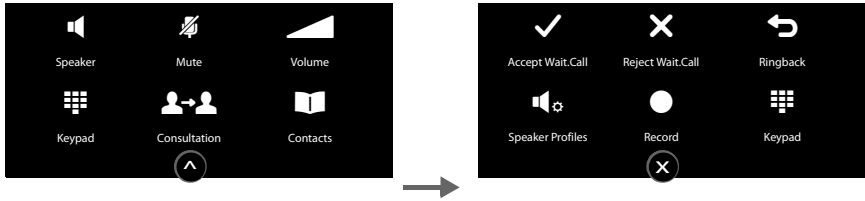

- ▶ Touch  to hide the additional options again.

Changing the settings

Touch an icon on one of the menu pages to open the corresponding application/function. The display shows the configurable parameters and user interface elements as well as their current settings (orange in the display).

Examples:

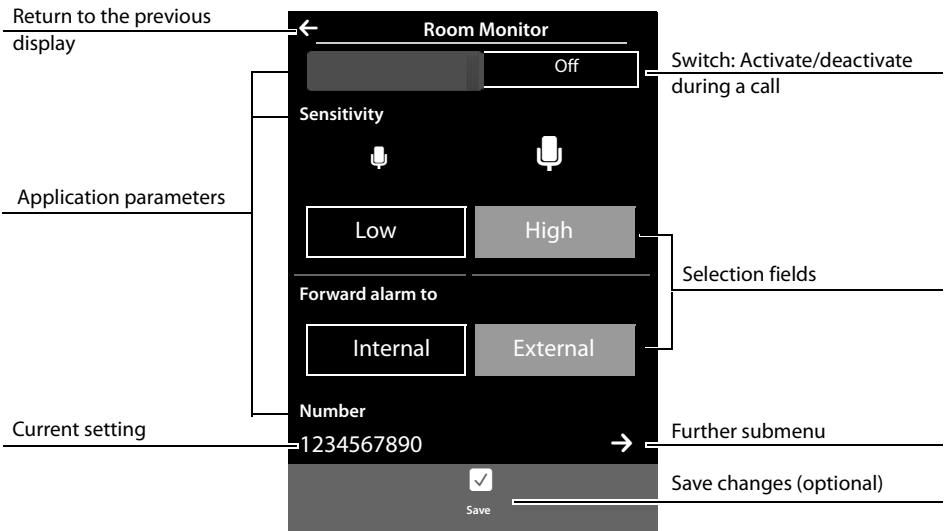

Switch: Activating/deactivating functions

- ▶ **Briefly** touch the switch to activate/deactivate functions such as baby-phone call or answering machine.

The function is activated/deactivated if the orange-coloured area (**On / on**) is visible.



Selection fields

If two or three alternative settings are available for one parameter, these alternatives are displayed in the form of selection fields. The current setting appears in orange.

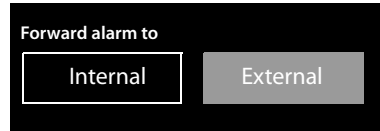

- ▶ To change it, briefly touch the selection field you require.

Opening the submenu to set a parameter

The  icon indicates that another submenu is available.

- ▶ Briefly touch  to open this submenu.

Return to the previous display

- ▶ You go back to the previous display (step by step) by touching  (in the top left of the display).

Entering numbers and text

Touch a character on the display to enlarge it. Keep your finger on the display until you see the desired character enlarged. As soon as you remove your finger from the display, the character is copied to the text field in which the cursor is blinking.

When numerous number and/or text fields are displayed (e.g., first name and surname in a Contacts entry), the first field is automatically activated. You need to touch any subsequent fields to activate them. A field is activated when the flashing cursor appears in the field.



Using the telephone































Correcting incorrect entries

Briefly touch : The last character you entered is deleted.













Press and **hold** : The entire content of the number or text field is deleted.

Entering text





- ▶ Touch  (Shift): Switch between lower and upper case.
Upper case is only activated for the next character.
In Contacts, the first letter and each letter following a space is automatically in upper case.
- ▶ Touch : Enter a digit/a special character.
 - ▶ Touch **More...** to display additional special characters, and touch **Back** to return to the previous display
 - ▶ Touch  to return to entering normal characters.
- ▶ You enter special characters (diacritical characters, e.g., umlauts) by pressing and **holding** the corresponding initial letter and selecting the required character from the list displayed.
Latin (default) character set:

a         c  e     i    
l  n  o      s  u    
y  z 



Greek character set:

α  ε  η  ι    ο  σ  υ    ω 

Cyrillic character set:

е  и  р  б 

Due to the larger space requirement of the Cyrillic character set, you can also access the following letters by pressing and **holding** the bold characters shown below. Touch the required character.

ц  х  ж 

- ▶ Touch  (if necessary several times): switch character set/keyboard assignment. The options are:
 - Latin (default) character set with the keypad layouts QWERTZ, for Central Europe, QUERTY (American default) and AZERTY, for the French-speaking area
 - Greek character set
 - Cyrillic character set

Making calls

Making an external call

- ▶ Switch to the dial page ▶ Enter the number ▶ **Briefly** press .

Or:

- ▶ In idle mode, press and **hold**  ▶ Enter the number.

You can cancel dialling by pressing .

Dialling with the redial list

- ▶ In idle mode, **briefly** press  to open the redial list.

You have the following options:

- ▶ Press . The number with the green dot is dialled.

Or:

- ▶ Touch an entry in the list. This selects the number displayed in the entry.

Or:

- ▶ Next to an entry, touch  The detail view is opened.

- Contacts entry exists:

All numbers for the Contacts entry are displayed:

- ▶ Press . The preferred number of the Contacts entry which is marked with a green dot (→ page 53) is dialled.

Or:

- ▶ Touch the desired number.

- No Contacts entry exists: Press .

Redial list (example):



Please note

The redial list contains the last twenty numbers dialled with this handset. You can manage them in the same way as the message lists on your telephone:

- ▶ **Open the detail view:** Next to the entry, touch  The display shows all the available information. In the detail view, you can delete the entry or add the number of the entry to Contacts (→ page 56).

Dialling from a call list

- ▶ Switch to the message page ▶ Touch .

You have the following options:

- ▶ Press . The number of the entry marked with the green dot is dialled.

Or:



- ▶ **Briefly** touch an entry in the list. This selects the number displayed in the entry.

Or:

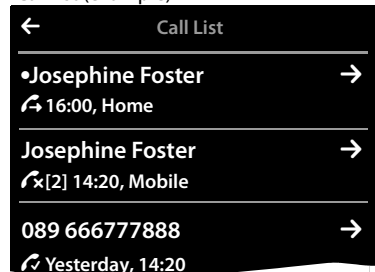
Call list (example)



Making calls

- ▶ Next to an entry, touch  The detail view is opened.
 - ▶ Press . This selects the number displayed in the entry.
- Or:
 - ▶ Contacts entry exists: Touch  All numbers for the Contacts entry are displayed. Touch the desired number.

Detail view of an entry (example)



Dialling with Contacts

- ▶ **Open Contacts:** On the dial page, touch [ **Contacts**]. The list of Contacts entries is displayed.
- ▶ Scroll through the list to the desired entry.

You have the following options:

- ▶ Press . The preferred number (→ [page 53](#)) of the entry marked with the green dot is dialled.

Or:



- ▶ Touch the name in the entry. The preferred number of the entry is dialled.

Or:

- ▶ Touch  next to the entry and then touch the required number in the detail view.

Accepting a call

You have the following options

- ▶ Press .
- ▶ If **Auto Answer** is activated (→ [page 35](#)), remove the handset from the charging cradle.
- ▶ Gigaset SL910A: Touch [ **Divert**] to divert the call to the answering machine (→ [page 43](#)).
- ▶ **Accept a call on a Bluetooth headset:** → [page 52](#)
- ▶ **Accept a call on a wire-bound headset:** Press the talk key (push-to-talk key) on the headset. The headset must be connected to the handset (→ [page 1](#)).
- ▶ **Accept a call on the Gigaset L410 handsfree clip** → [page 87](#): Press the talk key. The Gigaset L410 must be registered with the base station. Further information is available in the operating instructions for the Gigaset L410.

Call display

For calling line identification

The caller's phone number is displayed. The display will also show the number type and the name of the caller if the caller's number is stored in your Contacts. If you have assigned a picture to the caller's number (→ [page 53](#)), it also appears on the display.

No calling line identification

Instead of name and number, the following is displayed:

- ◆ **External:** No number is transferred.
- ◆ **Withheld:** Caller has withheld calling line identification.
- ◆ **Unavailable:** Caller has not requested calling line identification.

Notes on phone number display (CLIP)

(CLIP = Calling Line Identification Presentation)

The default setting on your phone is set to display the caller's number, → page 81 or

→ www.gigaset.com/service

Speaker

If you are going to let someone listen in, you should tell the other party that this is happening.

Activating handsfree mode while dialling

- ▶ Enter the number, press  twice.

Switching between earpiece and handsfree mode

During a call, when establishing the connection and when listening to the answering machine (Gigaset SL910A only):



- ▶ Press  or touch [ Speaker].

Place the handset in the charging cradle during a call:

- ▶ Press and hold the  key while placing the handset in the charging cradle and hold for a further 2 seconds.

Changing the earpiece, handsfree and headset volume

You adjust the volume for the current mode (handsfree, earpiece, headset) during a call:

- ▶ Touch [ Volume] ▶ Adjust the volume with \oplus / \ominus .
- ▶ If a headset is connected: To adjust the **Microphone Sensitivity** touch \oplus / \ominus in the second row several times if necessary.
- ▶ Touch [] at the bottom of the display to save the settings.
Or: The setting is saved automatically after approximately 2 seconds.

Activating/deactivating the microphone (muting)

If you turn the microphone off during a call, your caller can no longer hear you.

- ▶ To activate/deactivate the microphone, touch [ Mute].

Deactivating the ring tone/silent alert for the current call

A call is signalled on the handset:

- ▶ Touch [ Silence].

Security check

The handset detects unsecured connections to the base, which third parties could use to listen in.

When establishing an external call or during an external call:



- ▶ Press and **hold** any position on the status bar.

If **Secure connection to base** is displayed, the connection is secure.



If **No secure connection to base** is displayed, you should end the call.

Using provider-specific functions (network services)

You have to request these services from your network provider (there may be additional charges). Network services fall into two distinct groups:

- ◆ Network services that are activated outside of a call for the next call or all subsequent calls (e.g., "Divert calls to a different phone connection", "Withhold number (no calling line identification)"). You can activate/deactivate these network services via the submenu [ **Select Services**] on the menu page **Settings**.
- ◆ Network services that are activated during an external call, e.g., "Consultation call", "Swap between two callers", "Set up conference calls". These services are provided to you during an external call in the option slider (e.g., [ **Consultation**]).

Please note

- ◆ To activate/deactivate the following services, a code is generally sent to the telephone network.
 - ▶ After a confirmation tone from the telephone network, press .
- ◆ All of the functions that you can activate under the [ **Select Services**] menu item are services provided by your network provider. If you require assistance, please contact your network provider.
- ◆ It is not possible to reprogram the network services.

Network services during an external call

Consultation call

Making another external call **during** an external call. The first call is placed on hold.

- ▶ Touch [ **Consultation**] and then **External**
- ▶ Enter the number of the second participant.

The previous call is placed on hold. The second number is dialled.

- ▶ The person you have dialled does not answer: Touch  at the bottom of the display.

Or:

- ▶ The person you have dialled answers: Speak with the person you have called.

Ending a consultation call:

- ▶ Touch  next to the consultation call. You are reconnected to the first call participant.

Or:

- ▶ Press . You receive a recall from the first participant.

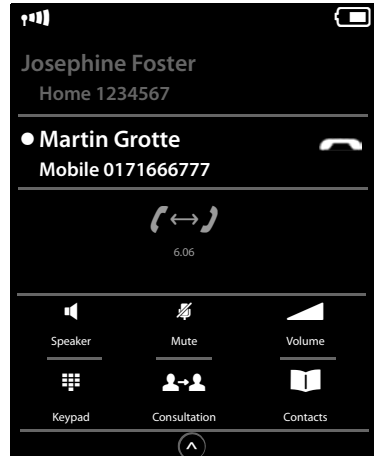

Changing phone settings

The handset and base are preconfigured, but you can change the settings to suit your individual requirements.

You can change settings either during a call or in idle status via the **Settings** menu page.

Changing the display language

- ▶ Menu key ▶ Menu page **Settings** ▶ [**Language + Location**].
- ▶ Next to **Display Language** touch ▶ Next to the selected language, touch (= selected) ▶ Confirm with ▶ Return with .

Setting the country and your own area code

- ▶ Menu key ▶ Menu page **Settings** ▶ [**Language + Location**] ▶ Continue → page 12.

Setting the display

Setting the screensaver/Slideshow

You can define a screensaver for the display's idle status. The options are **Analogue Clock/Digital Clock/Slideshow**/pictures. You can load pictures onto your handset using the **Gigaset QuickSync** (→ page 68) software.

To show the idle display again, **briefly** press or touch the display.

- ▶ Menu key ▶ Menu page **Settings** ▶ [**Display + Keypad**].
- ▶ Use the switch to activate/deactivate the screensaver.
 - ▶ Next to **Selection** touch ▶ Drag your finger horizontally across the display to scroll through the selection ▶ Touch [**Select**] to select the current display, or touch to go back without saving.

[**Display + Keypad**] submenu

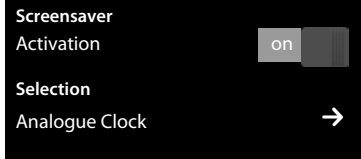

Setting the display backlight

The display backlight switches itself on as soon as the handset is moved or you press a key.

You can specify the period of time in idle status after which the display backlight is switched off. If no period is set, the display is permanently dimmed.

- ▶ Menu key ▶ Menu page **Settings** ▶ [**Display + Keypad**].
- ▶ Using the switch, activate/deactivate the display backlight in the charger cradle or outside the charger cradle.
- ▶ Next to **Timeout** touch ▶ Select the off time. Save and go back with .

[**Display + Keypad**] submenu

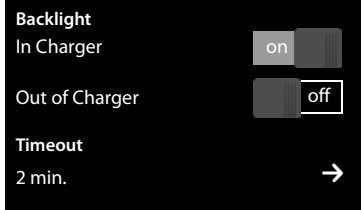



Please note

The handset's standby time can be significantly reduced if the display backlight is activated.

Switching off the message pop-up and the flashing message LED

Specify whether or not a message pop-up appears, or whether the message LED on the handset should flash to signal the receipt of new messages.

In idle status:

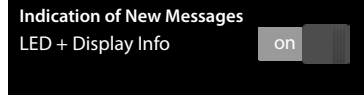

- ▶ Menu key  Menu page **Settings**
 - ▶ [ **Display and Keypad**]
- ▶ Activate/deactivate the message display with the switch next to **LED + Display Info**.

[ **Display and Keypad**] submenu



Activating/deactivating auto answer

When auto answer is activated the handset accepts an incoming call as soon as you take it from the charger cradle.

- ▶ Menu key  Menu page **Settings** ▶ [ **Telephony**].
- ▶ Activate/deactivate the function with the switch next to **Auto Answer**.

The connection is terminated as soon as you return the handset to the charger cradle, regardless of the **Auto Answer** setting. Exception: you press  when returning the handset to the charger cradle and hold it for two more seconds when it is in place.

Setting a speaker profile

You can set various speaker profiles to optimally adapt your phone to your environment. Try them out to see which profile you prefer.

The default is **Profile 1**.

During an external call in speaker mode:

- ▶ In the option slider, touch  and then [ **Speaker Profiles**] ▶ Select a profile. The setting is adjusted immediately.

Setting ring tones

Setting volume, melody

- ▶ Menu key  Menu page **Settings** ▶ [ **Audio Settings**] ▶ **Ringtones**

Changing phone settings

Ring tone volume for all calls

- ▶ Touch \oplus / \ominus , several times if necessary, to adjust the volume.

Or

- ▶ Activate/deactivate the crescendo ring tone (increasing volume) with the switch next to **Crescendo**.

The activated crescendo only applies to ring tone volume. It does not affect how a melody is played back.

Setting the ring tone for external/internal calls

- ▶ Next to **Int. Calls** / **Ext. Calls** touch \rightarrow ▶ Select a ringer melody ▶ Save and return with \leftarrow .

You can load additional ring tones onto your handset using the **Gigaset QuickSync** (\rightarrow page 68) software.

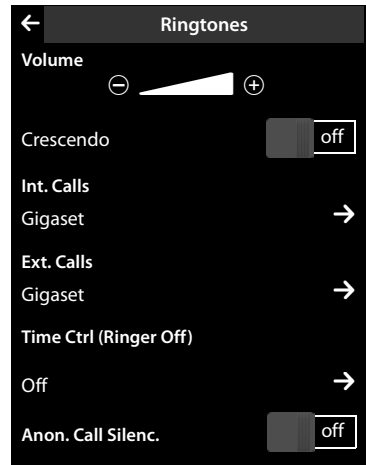

Activating/deactivating silent alert.

- ▶ Menu key \bigcirc ▶ Menu page **Settings** ▶ [\mathbb{A} **Audio Settings**] ▶ Activate/deactivate silent alert using the switch next to **Silent Alert**.

An activated vibration alert signals each internal/external call, appointment, birthday and each wake-up call, without differentiating between them.

The silent alert is deactivated as long as the handset is in the charger cradle or is connected to your PC via USB.

Permanently activating/deactivating the ring tone

You can permanently activate/deactivate the ring tone.

- ▶ Open the status page ▶ Activate/deactivate the ring tone with the switch next to **Do not disturb**. This setting has no effect on the silent alert.

The \mathbb{A} icon in the status bar indicates that the ring tone is deactivated.

Activating/deactivating advisory tones

Your handset uses advisory tones to tell you about different activities and statuses. These advisory tones can be activated/deactivated independently of each other.

- ▶ Menu key \bigcirc ▶ Menu page **Settings** ▶ [\mathbb{A} **Audio Settings**].

You can activate/deactivate the following functions with the switches to the right:

- **Confirmations:**

Confirmation/error tone after input; advisory tone on receipt of a new message.

- **Battery Warning:**

Warning tone when the battery charge is less than 10% (every 60 seconds). The battery warning tone does not sound when the baby phone call is activated.

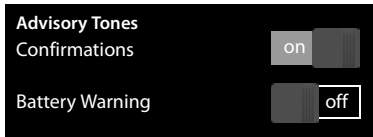

In the [\mathbb{A} **Audio Settings**] submenu:



Protection from undesired calls

Setting time control for external calls

You can specify a time period when you do not want the telephone to ring.

- ▶ Menu key  ▶ Menu page **Settings** ▶ [ **Audio Settings**] ▶ **Ringtones**
- ▶ Next to **Time Ctrl (Ringer Off)** touch  ▶ Touch **Switch off ringtones from** ▶ Set the start of the time period ▶ Save and return with  ▶ Repeat the process for **until**, set the end of this time period ▶ Activate/deactivate the time control with the switch next to **Activation** ▶ Go back with .



You have to set this function individually on each handset.

Please note

During this period, you will continue to receive calls from numbers to which you have assigned a personalised ring tone in Contacts (VIP).

Protection from anonymous callers

You can set the telephone in such a way that it does not ring for anonymous calls (when the caller has suppressed Calling Line Identification), but only shows these in the display.

- ▶ Menu key  ▶ Menu page **Settings** ▶ [ **Audio Settings**] ▶ **Ringtones**
- ▶ You can activate/deactivate this function using the switch next to **Anon. Call Silenc.** (on = ring tone deactivated).

This setting is now valid for all registered handsets.

Activating/deactivating music on hold

You can activate/deactivate the music on hold for external callers with an internal consultation call and call divert.

- ▶ Menu key  ▶ Menu page **Settings** ▶ [ **Audio Settings**].
- ▶ If necessary, scroll to **Music on Hold** ▶ Activate/deactivate the music on hold with the switch.

Activating/deactivating repeater

You can increase the range and signal strength of the base using a repeater. To do so, you must activate repeater operation. During activation, calls currently taking place via the base are cancelled.





- ▶ Menu key  ▶ Menu page **Settings** ▶ [ **System**].
- ▶ Activate/deactivate the repeater operation with the switch next to **Repeater Mode**.

After activating or deactivating the repeater, switch your handset off and on again (→ page 24).

Please note

- ◆ If you are using a repeater, ECO DECT settings are not available.
- ◆ You can connect up to six Gigaset repeaters to your base station.

Changing the system PIN

- ▶ Menu key  ▶ Menu page **Settings** ▶ [ **System**].
- ▶ Next to **System PIN** touch  ▶ Enter the current PIN (default: **0000**) and confirm with 
 - ▶ Enter the new system PIN (4 digits; 0 – 9) and confirm with .

Resetting the system PIN

If you have forgotten your system PIN, you can reset it to **0000**. If you do this, **all the base settings** are reset and **all the handsets** are deregistered!

- ▶ Remove the power cable from the base ▶ Press and hold the registration/paging key on the base and at the same time reconnect the power cable to the base ▶ Press and hold the registration/paging key until it begins to flash (approx. 10 seconds).

Restoring the phone to factory settings

You can reset individual changes to the base and handset separately.



The following are **not** affected by the reset:

- ◆ Date and time
- ◆ Registration of handsets to the base or registration of one handset to multiple bases, and the current base selection,
- ◆ System PIN
- ◆ Entries in the calendar and in Contacts
- ◆ Redial list and the content of the media pool
- ◆ Stored external and internal destination numbers for the baby phone call (**Forward alarm to** is reset to **External**)
- ◆ Destination number for call divert.

Resetting the handset (**Handset Reset**) deletes your settings for the configurable page (→ [page 18](#)) and your audio and display settings.

Resetting the base (**Base Reset**) resets the settings for ECO DECT, SMS, answering machine, system settings and the internal names of handsets, and also deletes call /answering machine lists.

Resetting the handset/base

- ▶ Menu key  ▶ Menu page **Settings** ▶ [ **System**].
- ▶ Touch **Handset Reset** or **Base Reset** ▶ With **Base Reset**: Enter the system PIN and confirm with 
 - ▶ Answer the security prompt with **Yes**.

In the [ **System**] submenu:



ECO DECT indicates low energy consumption and reduced transmission power.

Reduced transmission power (radiation)

In normal operation mode (factory setting):

On delivery, the device is set to maximum range. This guarantees optimised wireless management. The handset does not emit a signal in idle status (no radiation). Only the base ensures contact with the handset is maintained through low-strength wireless signals. During a call the strength of the wireless signal is adapted automatically to the distance between the handset and base. The smaller the distance between the handset and base, the lower the transmission power.

You can further reduce the transmission power as follows:

1) Reduce the range to decrease transmission power by up to 80%

Many apartments, business premises, offices, etc., do not need the maximum range. If you deactivate the **Max. Range** setting, transmission power during a call is reduced to 80% at half the range.

▶ Menu key  ▶ Menu page **Settings** ▶ [ **System**] ▶ Activate/deactivate it using the switch next to **Max. Range**.

Or:

▶ Open the status page (→ page 22) ▶ Activate/deactivate this using the switch next to  **Max. Range**.

Display icon for reduced range → page 72.

2) Deactivating the DECT wireless module in idle status (Eco mode+)

You can deactivate the wireless signal output from the base completely in idle status via the **No Radiation** setting.



▶ Menu key  ▶ Menu page **Settings** ▶ [ **System**] ▶ Use the switch next to **No Radiation** to activate/deactivate the function (**on**= transmission power deactivated).

Or:

▶ Open the status page (→ page 22) ▶ Activate/deactivate this using the switch next to  **No Radiation**.

When the wireless module is deactivated the idle display shows the  icon instead of the signal strength icon.

Please note

- ◆ To benefit from **Eco mode+**, all registered handsets must support this function.
- ◆ The wireless connection is established automatically for incoming or outgoing calls only. This causes a connection delay of approx. 2 seconds.
- ◆ Handsets need to "listen in" to the base, i.e., scan the surrounding area, on a regular basis to enable them to establish a connection to the base quickly in the event of an incoming call. This increases power consumption and therefore reduces the handset's standby time and talktime.
- ◆ When **Eco mode+** is activated (no radiation) the handset does not display a range indicator/range warning. You can check availability by calling a line: Press and hold the talk key . You hear the dial tone.
- ◆ If a handset registered on a base in **Eco mode+** does not support this feature, **Eco mode+** is automatically deactivated (range indicator  is activated on handsets and the switch turns to **off**). As soon as the incompatible handset is de-registered again, **Eco mode+** is reactivated automatically.

Answering machine (Gigaset SL910A)

Open the submenu for setting and operating the answering machine:

- ▶ Menu key **O** ▶ Menu page **Settings** ▶ [**☰**] **Answer Machine**

Or:

- ▶ Open the status page (→ page 22) ▶ Touch **☰** **Answer Machine**.

Activating/deactivating the answering machine

- ▶ Activate/deactivate the answering machine with the switch next to **Activation**.

Setting up the answering machine

Define Mode

- ▶ Touch the corresponding area (activated mode is highlighted).
 - **Announcement:** The caller can leave messages.
 - **Advisory Message:** The caller only hears a recorded message.
 - **Time Control:**
 - ▶ Next to **Announcement from/ Advisory Message from** touch **➔** ▶ Enter the times when the relevant mode should be activated
 - ▶ Save and return with **⬅**



Recording a personal announcement/ advisory message

Recording a new announcement deletes the announcement previously saved.

- ▶ Scroll to **Announcement** or **Advisory Message** and touch the relevant **➔**
- ▶ Touch [**●** **Record own**] / [**●** **Re-Record**] ▶ Record an announcement after the ready tone (minimum 3 seconds up to a maximum of 180 seconds).
- ▶ Touch [**■** **End**] to complete and save the recording.

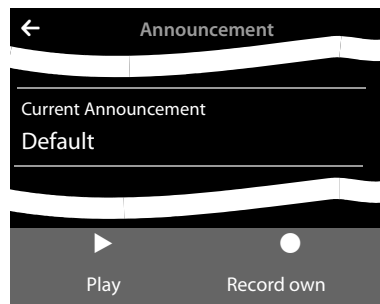

Cancel a recording: Briefly press the end call key **☎** or touch **⬅** while recording.

After recording you can:



- ▶ **Listen to the announcement:** Touch [**▶** **Play**].
- ▶ **Repeat your recording:** During playback, touch [**●** **New**].
- ▶ **Delete the recording:** Touch [**🗑** **Delete**] and confirm with **Yes**.

Please note

- ◆ Recording ends if there is a pause lasting longer than 3 seconds.
- ◆ If you cancel the recording, the default announcement is used.
- ◆ If the answering machine's memory is full, it switches to **Advisory Message** mode. After old messages have been deleted, it switches back into **Announcement** mode.

Additional setting options

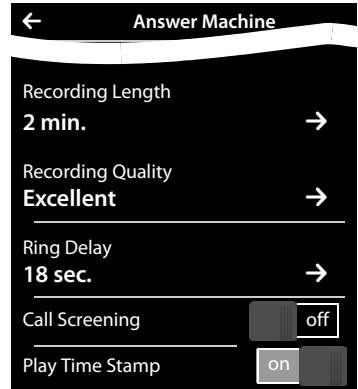

◆ Setting the recording parameters:

- ▶ Scroll until you reach the desired recording parameter:
- **Recording Length:** 1 min., 2 min., 3 min. or **Maximum**.
- **Recording Quality:** Excellent or Long Play.
- **Ring Delay:** No Delay, 10 sec., 18 sec., 30 sec. or **Automatic** (10 seconds if there are new messages, otherwise 18 seconds).
- ▶ Next to the relevant recording parameter, touch 
 - ▶ Touch the desired setting ( = selected)
 - ▶ Save and return with 





◆ Switching call screening on/off on the handset:

- ▶ Touch the switch next to **Call Screening**.





Deactivating call screening for the current recording: ▶ Touch [ **Silence**] or press .

◆ Activating/deactivating playback of the recording time: ▶ Activate/deactivate playback with the switch next to **Play Time Stamp**.

Playing/deleting messages

- ▶ Switch to the message page ▶ Touch the  icon.
 - ▶ **Listen to all new messages:** Touch [ **Play all new**].
 - ▶ **Listen to individual messages:** Touch list entry.
 - ▶ **Call the caller of the entry marked with the green dot:** Press .

The following options are available during message playback:

- ◆ Adjust the playback volume: [ **Volume**],
- ◆ Repeat the last 5 seconds of playback: [ **5 sec.**],
- ◆ Copy the caller's number to contacts: [ **Copy Number**],
- ◆ Delete message: [ **Delete**].

Deleting all messages

- ▶ Menu key  ▶ Menu page **Settings** ▶ [ **System**] ▶ (Scroll if necessary) ▶ Next to **Clean-up List** touch  ▶ Touch  next to **Answer Machine** ▶ Confirm with **Yes**.

More answering machine functions

◆ Pick up call during answering machine recording

- ▶ Press  or touch [✓ Accept].

◆ Divert call to answering machine:

If the answering machine is switched on and the handset is displaying an external call

- ▶ Touch [ Divert]. The answering machine starts immediately in **Announcement** mode.

◆ Two-way recording of external call: ▶ In the options bar, touch ▶ Touch [● Record] to start and end the two-way recording.

Tell the other party that the call is being recorded.

During a two-way recording, all options apart from [● End Recording] are greyed out. You cannot initiate a consultation call, nor accept nor reject a waiting call.

Operating when on the move (remote operation)

Check or activate the answering machine from another telephone (e.g., from a hotel, mobile phone).

Prerequisites: The current system PIN is set to something other than 0000 (→ page 38) and the other telephone has tone dialling (DTMF). Alternatively, you can use a code transmitter (available from retailers).

Activating the answering machine

Prerequisite: The answering machine is deactivated.

- ▶ Call your phone line and let it ring until you are prompted to enter the system PIN.
- ▶ Enter the system PIN for your phone within 10 seconds.

Calling the answering machine and playing back messages

Prerequisite: The answering machine is activated.

- ▶ Call your phone line ▶ When you hear your announcement: Press  ▶ Enter your telephone's system PIN.

You can operate the answering machine with the following keys.

- 1** During the time stamp playback:
Go to the previous message.
During message playback:
Go to the start of the current message.
- 2** Stop playback. Press again to resume.
After a pause of approx. 60 seconds, the connection is ended.
- 3** Go to the next message.
- 4** Skip back five seconds in the current message.
- 0** Delete current message.
- *** Change the status of a previously played back message to "new".

Answering machine (Gigaset SL910A)

Cancelling remote operation

- ▶ Press the end call key or replace the earpiece.





Please note

The answering machine will terminate the connection under the following circumstances:

- ◆ An incorrect system PIN has been entered.
- ◆ There are no messages on the answering machine.
- ◆ After the remaining memory has been specified.

Network mailbox

You can only use the network mailbox if you have **requested** it from your provider and saved the network mailbox number in your phone.

- ▶ Menu key  ▶ Menu page **Settings** ▶ [ **Network Mailbox**].
- ▶ Enter the network mailbox number: Next to **Access Number** touch  ▶ Enter number ▶ Confirm and save with .
- ▶ Activate/deactivate network mailboxes (if your network provider supports this function): Touch **On/Off**
 - ▶ After the confirmation tone from the telephone network, press .

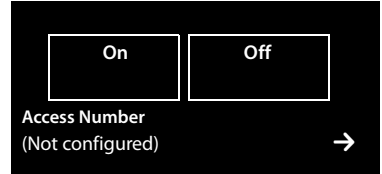

After saving the phone number, the following icon is displayed on the message page:



There are new messages
(if your network provider supports this function)

Playing back network mailbox messages

- ▶ Switch to the message page ▶ Touch the  icon.

Your network mailbox is called directly. The handsfree mode is activated on the handset. You can listen to the messages.

Multiple handsets

Registering handsets

You can register up to six handsets to your base. You must initiate registration of the handset on **both** the base **and** on the handset. Both must occur **within 60 seconds**.

- ▶ **On the base:** Press and **hold** (at least 3 seconds) the registration/paging key.
- ▶ **On the SL910H handset** (for other handsets see "Notes"):

- ▶ Touch **Register**

or

- ▶ Menu key  ▶ Menu page **Settings** ▶ [ **Handsets + Base**]
 - ▶ Touch **Register**.

This creates a connection to the base, but it may take some time.

- ▶ If necessary, enter the system PIN (default: **0000**) ▶ Confirm the PIN with .

Successful registration is shown on the display. Adjust the handset's setting using the **Settings** menu (→ page 9).

Please note

- ◆ If six handsets are already registered with the base (all internal numbers occupied) then the most recently registered handset (e.g., INT 6) is replaced by the new handset. If this attempt is not successful, e.g., because this handset does not have a connection to the base, the message **No free internal number** is displayed. In this case, de-register another handset that is no longer required and repeat the registration procedure.
- ◆ You should start the registration procedure for **other Gigaset handsets** and handsets of other GAP-enabled devices in accordance with the respective operating instructions.



Using the handset on multiple bases

Your handset can be registered on up to four bases.

The active base is the last one your handset was registered with. The other bases are stored in the list of available bases.

You can change the allocation to a base **manually at any time**.

Alternatively, you can set the handset so that it selects the base with the best reception (**Best Base**) as soon as the connection to the current base is lost.

- ▶ Menu key  ▶ Menu page **Settings** ▶ [ **Handsets + Base**].
- ▶ Touch **Connected to Base**  ▶ Select the desired base or select **Best Base** ( = selected).

Deregistering handsets

- ▶ Menu key ▶ Menu page **Settings** ▶ [**Handsets + Base**].
- ◆ You want to deregister the handset currently being used:
 - ▶ Touch **De-register** ▶ If necessary, enter the system PIN (default: **0000**) ▶ Confirm the PIN with ▶ Confirm the deregistration with **Yes**.

If the handset is still registered to other bases, it switches to the base with the best reception (**Best Base**; → page 46).
- ◆ You want to deregister another handset:
 - ▶ Touch **Registered Handsets** ▶ [**De-register**] ▶ Touch next to the appropriate handset ▶ [**De-register**] ▶ If necessary, enter the system PIN ▶ Confirm with **Yes**.

Locating a handset ("paging")

- ▶ Press the registration/paging key on the base station (→ page 2) **briefly**.

All the handsets ring simultaneously ("Paging"), even if the ring tones are deactivated (**Exception**: Handsets where baby phone call is activated).

Ending the search

- ▶ **On the base**: Press the registration/paging key **briefly**, or
- ▶ **On the handset**: Press or or touch [**Silence**], or
- ▶ **No action**: After approx. 3 minutes, the paging call ends **automatically**.

Changing the handset name

When you register multiple handsets the names **INT 1**, **INT 2** and so on are automatically assigned. To change the name:

- ▶ In the **Settings** menu, touch [**Handsets + Base**].
- ▶ Touch **Registered Handsets** ▶ Select handset.
- ▶ Delete the old name with and enter the new name (max. 10 alphanumerical characters)
 - ▶ Confirm with .

Making internal calls

Internal calls to other handsets registered to the same base are free of charge.

- ▶ Switch to the dial page ▶ Touch [**Internal!**] ▶ If necessary, select a handset from the list or touch **All Handsets (group call)**.

After opening the list, press to initiate a group call to all handsets.

Multiple handsets

Internal consultation/internal transfer

You are speaking with an **external** participant and want to consult an **internal** participant or transfer the call to him.

- ▶ Touch [ **Consultation**] and then **Internal**.
- ▶ If more than two handsets are registered to the base, select one handset or **All**.

Consulting: You consult the internal participant and return to the external call:

- ▶ Touch [ **End Consultation**].

Transferring the external call: you have two options to transfer the external call:

- ▶ You wait until the participant answers your call and then you hang up.
Press .

or

- ▶ You hang up before the participant answers your call: Press .

If the other participant does not answer your call, cancel the consultation call with [ **End Consultation**].

Please note

This equipment may not provide for the effective handover of a call to another device connected to the same line.

Call Waiting

Many Telecommunication providers in Australia offer a Call Waiting service on your home phone line. Please speak to your service provider to check if your home phone line is activated for this service (charges may apply).

Telstra (Australia):

The SL910 handset you have purchased has been preconfigured to work seamlessly with the Telstra network.

When you receive a second call whilst you are on the phone you will hear a beep. You are able to see what number is calling on the display (providing you have the caller ID function on your line). There will be a button on the screen to either accept or reject the call.

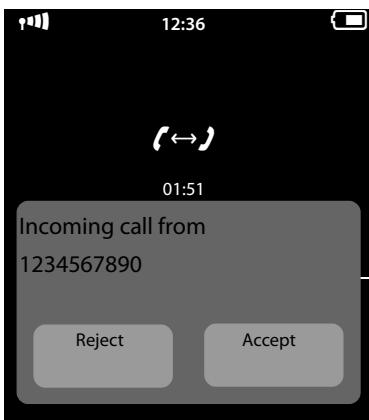

Number of caller

Prerequisite: activated CallerID function

Optus (Australia):

The SL910 handset you have purchased has the required information to work seamlessly with the Optus network in Australia. However there are some settings that need to be changed before these settings are activated.

To activate the SL910 Call Waiting feature for use on these networks please perform the following steps.

Changing the recall value:

Different provider uses different recall values.

Recall value for Australia 80ms to 120ms (100ms in delivery state)

Recall value for New Zealand 300 ms to 800 ms (600 ms in delivery state).

Please consider that the recall value is set to 100ms after a base reset. For other providers other recall values are possible

The most common providers instructions for Call Waiting are as follows.

Please note

These processes depend on the network provider and are subject to change.

Call waiting Telecom (New Zealand)

If you are in a call you will hear four call waiting tones.

Please consider, that no CLIP-information is available.

To accept the second call

- ▶ press keypad on the screen of the phone.
- ▶ press the recall key on your phone.

To return to the first caller

- ▶ press the recall key again and you will be able to continue your first conversation.

For more information please contact Telecom NZ.

Listening in to an external call

You are conducting an external call. An internal participant can listen in on this call and take part in the conversation (conference).

Prerequisite: The **Listening In** function must be activated.

Internal listening in

The line is engaged with an external call. Your screen will display information to that effect. You can listen in to the external call.

- ▶ Press and hold . All participants hear a signal tone. Call waiting is not displayed.

Ending listening in

- ▶ Press . All participants hear a signal tone.

Bluetooth devices

You can register up to five data devices (PC, PDA, mobile phones) and one Bluetooth headset. You must activate Bluetooth on the handset, ensure the devices are visible if necessary and then register the handset.

You can exchange entries in Contacts using the data devices and load ring tones and pictures to the handset using the **Gigaset QuickSync** software (→ page 68).

Please note

- ◆ A headset must have the **headset** or **handsfree profile**. The handsfree profile is preferred.
- ◆ Establishing a connection to a headset can take up to 5 seconds.

Activating/deactivating Bluetooth mode

You can activate/deactivate Bluetooth mode using the status page (→ page 22) or as follows:

- ▶ Menu key **O** ▶ Menu page **Settings** ▶ [**Bluetooth**] ▶ Activate/deactivate Bluetooth using the switch next to **Activation**.

If Bluetooth is activated:

- ◆ **Bluetooth** is displayed in the status bar (→ page 71).
- ◆ The handset can communicate with all devices in the **Known Devices** list.
- ◆ The handset is visible to Bluetooth devices within its range.
- ◆ If the known devices include a headset, the handset establishes a connection to this headset.
- ◆ The handset searches for Bluetooth devices within range.

Finding and registering (trusting) Bluetooth devices

The distance between the handset and the activated Bluetooth device should be a maximum of 10 m.

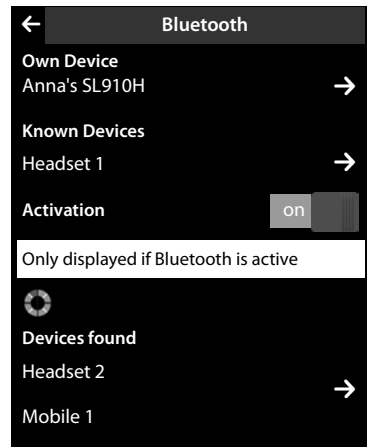

Please note

- ◆ If you register a headset, any previously registered headset is overwritten.
- ◆ If a headset is already registered to another device, please **deactivate** this connection before starting the registration process.

Starting the search

The search starts as soon as the Bluetooth page is opened and Bluetooth has been activated. The handset searches for Bluetooth devices within its range. Located devices are added to the **Devices found** list.

Pairing the device — adding the device to the known devices list

- ▶ Next to the list **Devices found** touch  (see image above).
- ▶ In the **Devices found** list, select device ▶ Touch [ **Trust Device**] ▶ If necessary, enter the PIN of the device to be registered ▶ Confirm with .

PIN for a **data device**: Enter any PIN on the handset and then also on the data device (0 – 16 digits).

PIN for a **headset**: **0000** is generally preset. Therefore, you only need to enter the PIN in exceptional cases.

If **Known Devices** already contains six entries, the last entry is overwritten.

Exception: a headset only overwrites a headset.

Ending the search

- ▶ Touch  to close the submenu **Bluetooth**, or deactivate Bluetooth.



Editing the list of paired (trusted) devices

Opening the list

- ▶ In the submenu **Bluetooth** next to **Known Devices** touch .

A  next to the device name in the list indicates a headset and  indicates a data device.

De-registering the device

- ▶ Open **Known Devices** list ▶ Touch [ **Delete**] ▶ Select one or more devices – next to the relevant devices, touch  ▶ Touch [ **Delete**] ▶ Touch **Yes**.

Changing the name of a device

- ▶ Open the **Known Devices** list ▶ Select device ▶ If necessary, delete the previous name with  ▶ Enter name (max. 16 characters) ▶ Confirm with .

Rejecting/accepting an unregistered Bluetooth device



If an unknown Bluetooth device tries to establish a connection, you will be asked to enter the device's PIN (bonding).

- ▶ **Reject**: Touch  or press .

Or:

- ▶ **Accept**: Enter the device PIN ▶ Confirm with .
 - ▶ Touch **Yes**: Add to the **Known Devices** list, or
 - ▶ Touch **No**: Temporarily use device.

Changing the handset's Bluetooth name

- ▶ In the **Bluetooth** submenu, touch **Own Device Own Device**. Activates Bluetooth if it is deactivated ▶ If necessary, delete the previous name with  ▶ Enter the new name ▶ Confirm with .

Continuing a handset call on the Bluetooth headset

Prerequisite: Bluetooth is activated; the Bluetooth headset and the handset are connected.

- ▶ Press the talk key on the headset.

It may take up to 5 seconds to establish a connection to the handset.

Use [ Volume] Headset Volume/Microphone Sensitivity to adjust.

For further details about your headset, see the accompanying user guide.

Please note

If a wire-bound headset and a Bluetooth headset are connected at the same time, you are unable to use the wire-bound headset.

Accepting a call on a Bluetooth headset

Prerequisite: Bluetooth is activated; the Bluetooth headset and the handset are connected.

Only press the talk key on the headset when the headset rings.

For further details about your headset, see the accompanying user guide.

Contacts (address book)

You can save up to eight numbers, together with the first name and surname, birthdays/anniversaries with signalling, VIP ring tone and caller picture in each **Contacts entry**. You can synchronise Contacts with the Outlook contacts in your PC address book and upload ring tones and pictures to your handset (→ [page 68](#)).

You can create a Contacts list (with up to 500 entries) individually for each of your handsets. You can also send lists/entries to other handsets (→ [page 55](#)). You can use your PC and the free Gigaset QuickSync software (→ [page 68](#)) to compare the Contacts list with your Google and Outlook contacts (→ [page 68](#)).

Please note

To quickly access a number from Contacts, you can place the number on the configurable page in the idle display (→ [page 18](#)).

Length of the entries

8 numbers: Max. 32 digits each
 First name and surname: Max. 16 characters each

Managing entries in Contacts

Opening Contacts

- ▶ Menu key ▶ [Contacts] or
- ▶ Touch [Contacts] on the dial page or during a call.

Creating a new entry

- ▶ Open Contacts ▶ Touch [New Entry].
- ▶ Enter the components of each entry via the individual fields (name, number, VIP ring tone, birthday). To do this, next to the relevant component, touch ▶ If available, confirm a component with or [Select].
 To create an entry, you must enter at least one number.
- ▶ **Add caller picture:** Touch []. Select picture with ▶ / and then touch [Select].
- ▶ **Define a preferred number for an entry:** The preferred number is automatically selected if you touch the entry in Contacts or press in the detail view. It is highlighted (in green).
 To change the setting: Press next to the desired number.

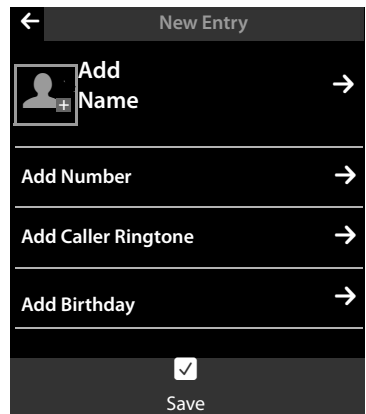

Saving a Contacts entry











- ▶ Touch [Save].

Viewing an entry (detail view)

- ▶ Open Contacts ▶ Next to the desired entry, touch 

All the information relating to the entry is displayed.





Editing entries

- ▶ Touch [ **Edit**] in the detail view.
 - Change/delete first name, surname, or number: ▶ Touch  ▶ If necessary, touch the corresponding field ▶ Enter/change name/number ▶ Confirm with .
 - Add number: Touch  next to **Add Number** ▶ Enter the number and confirm with .
 - Assign a VIP ring tone or delete a birthday: ▶ Next to **Add Caller Ringtone** / **Add Birthday** touch  ▶ Touch [ **No Ringtone**] / [ **No Birthday**].
 - Delete caller picture assignment: ▶ Touch the caller picture ▶ Touch [ **No Picture**].
 - Change preferred number: ▶ To activate a different preferred number, touch  next to this number.
- ▶ Touch [ **Save**].

Deleting an entry

- ▶ In the detail view: Touch [ **Delete**] ▶ Confirm with **Yes**.

Delete **all** entries in Contacts:



- ▶ Menu key  ▶ Menu page **Settings** ▶ [ **System**] ▶ (Scroll if necessary)
 - ▶ Next to **Clean-up List** touch  ▶ Next to **Contacts** touch  ▶ Confirm with **Yes**.

Displaying the number of entries that are still available in Contacts

- ▶ Open Contacts ▶ Touch [ **Memory**].

Defining the order of entries in Contacts

Define whether the entries are to be sorted by first name or surname.

- ▶ Open Contacts ▶ Touch [ **Surname**] or [ **First Name**]

If an entry does not contain a name, the preferred number (number marked with the green dot → [page 53](#)) is copied to the surname field. These entries appear at the beginning of the list, regardless of how the entries are sorted.

The sort order is as follows:

Space | Digits (0–9) | Letters (alphabetical) | Other characters.

Selecting a Contacts entry, navigating in Contacts

If there are more than seven entries in your Contacts list, a scroll bar appears on the right-hand side. You have the following options:

- ◆ Scroll to the name you are searching for.
- ◆ Touch the first letter in the index. The display jumps to the first name that begins with this letter. If necessary, scroll until you reach the desired entry. While you are scrolling, the index is temporarily covered by a scroll bar.

Transferring an entry/Contacts to another handset

Prerequisites:

- ◆ The sending and receiving handsets must both be registered to the same base.
- ◆ The other handset and the base can send and receive Contacts entries.

You can transfer the entire Contacts list, an individual entry or multiple individual entries.

Please note

- ◆ An external call will interrupt the transfer.
- ◆ Caller pictures and sounds are not transferred. For a birthday, only the date is transferred.
- ◆ When transferring an entry between two vCard handsets:
 - If the recipient does not yet have an entry with that name, a new entry is created.
 - If there is already an entry with that name, this entry is expanded with the new numbers. Where there are more than eight numbers in total, a second entry is created with the same name.
- ◆ If the recipient is not a vCard handset: an entry is created and sent for each number.
- ◆ Your handset receives entries from a non-vCard handset: entries with numbers already saved are rejected; otherwise a new entry is created.

Transferring individual entries

- ▶ Open the detail view of the entry (→ [page 54](#)) ▶ Touch [ Copy]
 - ▶ Respond to the prompt with **Internal Handset** ▶ Select the recipient handset.

After a successful transfer:

- ▶ Touch **Yes** if another entry should be sent. Otherwise touch **No**.





Transferring the entire Contacts list

- ▶ Open Contacts (→ [page 53](#)). Touch [ Copy List] ▶ Respond to the prompt with **Internal Handset** ▶ Select the recipient handset.

Cancel transmission

- ▶ Press .

Transferring Contacts as a vCard with Bluetooth

- ▶ Open Contacts (→ page 53).
 - ▶ **Send entire Contacts list:** Touch [ Copy List].
- Or:
 - ▶ **Send entry:** Next to the entry, touch  and then touch [ Copy].
- ▶ In the pop-up that is displayed, touch **BluetoothDevice**. Bluetooth is activated, if necessary.
- ▶ Select recipient:
 - ▶ Select the recipient from the list of known devices (→ page 51). The transfer starts. Or:
 - ▶ Touch [ Search] and select the recipient from the **Devices found** list ▶ Enter the recipient's PIN and touch .

Receiving a vCard with Bluetooth

Prerequisite: the handset is in idle status. Bluetooth is activated.



- ▶ If the sender is in the **Known Devices** (→ page 51) list, receipt occurs automatically.
- ▶ If the sender is not in the **Known Devices** list, enter the sender's device PIN and touch . Following the vCard transfer, state whether the device should be added () to the **Known Devices** list (**Yes**) or not (**No**).

Adding a displayed number to Contacts

You can copy numbers that are displayed in a list (e.g., call list, redial list, answering machine list, SMS inbox or drafts list) or in an SMS message, as well as numbers that you have just dialled or entered for dialling, to Contacts.

- ▶ On the dial page or in the detail view of a list entry, touch [ Copy Number] (you may have to scroll in the options bar).

Or:

- ▶ In the detail view of an SMS, touch the sender or recipient field, or touch a highlighted number in the SMS message. In the pop-up that is displayed, touch **Copy to Directory**.
- ◆ **Create new entry:** ▶ Touch [ New Entry]. The number is transferred as the first number of the entry with number type **Home** ▶ Extend the entry if necessary ▶ Touch [ Save].

Or:

◆ Add a number to an existing entry:



- ▶ Select entry ▶ Touch the **Add** switch.
- Number is entered with number type **Home** ▶ If necessary, extend or change the entry
- ▶ Touch [ Save].

Or:

- ▶ Select entry ▶ Select the number that you want to overwrite ▶ Touch **Yes**
- ▶ If necessary, extend or change the entry ▶ Touch [ Save].

Copying a number from Contacts

In certain operating situations you can open the Contacts list to copy a number, e.g., in the field **To** of an SMS text or when you are dialling (even after you have entered a suffix).

- ▶ Depending on the operating situation, open the Contacts list with [ **Contacts**] or .
 - ▶ Touch a Contacts entry to copy its preferred number.
- Or:
- ▶ Next to the entry, touch  and then touch the number to be copied.

Configuring QuickDial/QuickDial shortcuts

Prerequisite: There must be at least one number in Contacts.

You can provide numbers from Contacts for the QuickDial (QuickDial) in two ways:

- ◆ Create a symbol on the configurable (own) page for each number.
- ◆ Transfer a number to the QuickDial shortcuts.

Creating a QuickDial icon on the configurable page

- ▶ Switch to the configurable page and start the configuration (page 18).
- ▶ Drag icon  for the QuickDial from the pick list to the page ▶ Select the Contacts entry ▶ The detail view is displayed for an entry with several numbers: select the telephone number.

You can repeat this process several times with different numbers.

One of the icons on the right is created on the configurable page. The number is not entered into the QuickDial shortcuts.

Dial number: ▶ Touch the QuickDial shortcut icon on the configurable page.

Change QuickDial:

- ▶ Change the number in Contacts. The QuickDial on the configurable page changes accordingly.

Or:

- ▶ Delete the QuickDial on the configurable page and create a new QuickDial icon with the new number.

Delete QuickDial



- ▶ In configuration mode, drag the QuickDial icon to be deleted into the pick list. The Contacts entry does not change.

Or:

- ▶ Delete the number in Contacts. The QuickDial icon is automatically removed from the configurable page.

Transferring the telephone number to the QuickDial shortcuts

You can save up to 7 frequently dialled numbers from Contacts in the QuickDial list so you can access them quickly.

- ▶ Switch to the dial page ▶ Touch [ **QuickDial**] ▶ Touch [ **New Entry**] ▶ Select the Contacts entry ▶ The detail view is displayed for an entry with several numbers: select the telephone number.

Caller picture assigned:

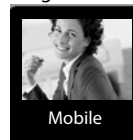

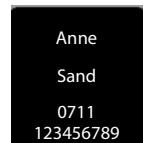

Otherwise:





Calls list

Dialling a number:

- ▶ Switch to the dial page ▶ Touch [ QuickDial] ▶ Select entry.
 - The number is dialled immediately if the number field on the dial page is empty.
 - If the number field already contains characters, the number behind this character is inserted in the number field.
 - ▶ If necessary, change the number in the number field ▶ Press .

Deleting entries:





- ▶ Touch [ Delete] ▶ Touch all the entries to be deleted in sequence and then touch [ Delete].

Please note





If you change/delete a number from Contacts, the same number is automatically deleted from the QuickDial list.

Calls list

Your telephone stores various types of calls:

- ◆  **All:** Full list (**Call List**) of all calls (missed, outgoing, incoming)
- ◆  **Missed:** List of missed (unaccepted) calls
- ◆  **Accepted:** List of accepted calls () and calls recorded by the answering machine (QQ, Gigaset SL910 A only)
- ◆  **Outgoing:** List of outgoing calls (dialled numbers)

The full list  displays up to 60 entries, the lists of the other call types shown the last 20 entries.

- ▶ If you open the call list via the messages page or the message pop-up (→ page 20), the **Missed Calls** is displayed.
- ▶ The full list of all calls is displayed when you open the call list via:
 - Menu key  ▶ [ Call List],
 - The option [ Calls] on the dial page
 - [ Call List] on the configurable page.

Switching between the lists of the different call types:

- ▶ At the bottom of the page, touch the icon for the desired call type.

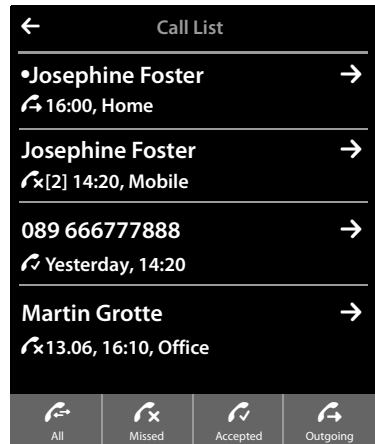

Calendar

You can remind yourself of up to **100 appointments**. Birthdays saved in Contacts are transferred to the calendar. The current day is highlighted in grey in the calendar. Days with appointments are marked with a coloured bar. When you select a day, it is highlighted in colour.

| Mo | Tu | We | Th | Fr | Sa | Su |
|----|----|----|----|----|----|----|
| 01 | 02 | 03 | 04 | 05 | 06 | 07 |
| 08 | 09 | 10 | 11 | 12 | 13 | 14 |
| 15 | 16 | 17 | 18 | 19 | 20 | 21 |

Saving appointments to the calendar

Prerequisite: The date and time have already been set (→ page 9).

- ▶ Menu key **O** ▶ [**22** Calendar] ▶ Touch **▶** / **◀** to set the month ▶ Touch the desired day and then touch [**New**].

The following information can be added:

- **Text:** Appointment name (e.g., dentist, cinema with Anna).
- **Time:** Time (hour and minutes) for the appointment.
- **Reminder:** You can also set a reminder in advance of the actual appointment. Use the slider to set a time between **15 min.** and **1 week**.
- **Sound:** Touch **🔔** / **🔕** to activate/deactivate the acoustic signal.

- ▶ Touch [**✔ Save**].

← 6 July 2010

Text

Appointment →

Time

22 58
23 59
00 : 00
01 01
02 01

Reminder

0 min. 15 min. 30 min. 1 hour 1 day 3 days 1 week

Sound: On

✔ Save

Setting the tones and volumes of the reminder signal

- ▶ Menu key **O** ▶ Menu page **Settings** ▶ [**🔊 Audio Settings**] ▶ Next to **Reminder Signal** touch **→**
- ▶ Set the volume using **⊕** / **⊖** or set increasing volume using the switch next to **Crescendo**
- ▶ Next to **Sound** touch **→** ▶ Select a ringer melody ▶ Save and return with **←**.

← Reminder Signal

Volume

⊖ ⊕

Crescendo off

Sound

Gigaset →

Signalling appointments and birthdays

An appointment/birthday is displayed in idle status and signalled for 60 seconds.

Deactivating the reminder signal and reacting with an SMS:

- ▶ Touch **Off** to acknowledge and end the reminder signal.

Or:

- ▶ Touch **Write Text Message**. The SMS editor is opened.

When you are on the phone, an appointment/birthday is indicated on the handset with a **single advisory tone**.

If the ring tone is deactivated, the reminder signal does not sound.

Displaying unacknowledged appointments/birthdays

The following appointments and birthdays are saved in the **Reminders / Events** list:

- ◆ You have not acknowledged the reminder for this appointment/birthday.
- ◆ The appointment/birthday was signalled during a phone call.
- ◆ The handset was deactivated at the time of the appointment/birthday.



The last 20 entries are displayed.

The **Reminders / Events** list is displayed on the messages page (→ **page 20**) with the icon next to it:

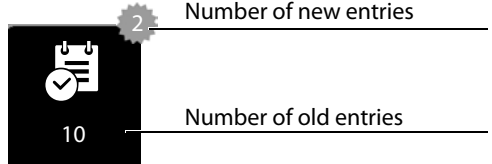
- ▶ **Open list:** Switch to the messages page and touch .



Deleting entries

- ▶ Open list ▶ Touch [ **Delete**] ▶ Touch all the entries to be deleted in sequence and then touch [ **Delete**].

Deleting all appointments from the list:





- ▶ Menu key  ▶ Menu page **Settings** ▶ [ **System**] ▶ **Clean-up List** (scroll if necessary)
 - ▶ Next to **All Past Appointments** touch  ▶ Confirm with **Yes**.

All expired appointments from the calendar and all entries from the **Reminders / Events** list are deleted.

Alarm

Prerequisite: The date and time have already been set (→ page 9).

You can activate/deactivate and set the alarm clock using the status page (→ page 22) or as follows:

- ▶ Menu key \circ ▶ [ **Alarm**] ▶ Activate/deactivate the alarm clock with the switch at the top of the display.
- ▶ Touch [ **Edit**] to change the settings for the alarm.
- ▶ Set the hour and minutes for the wake-up time (time setting → page 10).
- ▶ In the following line, touch the weekdays when the alarm clock should sound (orange = selected).
- ▶ Next to **Ringtone** touch  ▶ Select the ringer melody for the wake-up call ▶ Go back with .
- ▶ Touch [ **Save**].

A wake-up call is signalled in the display and with the selected ring tone for a maximum of 180 seconds. During a call, the wake-up call is only signalled by a short tone.

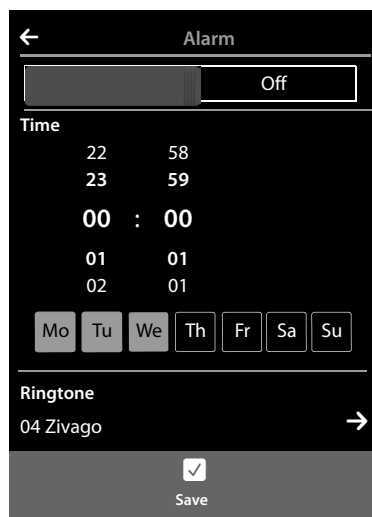

Please note

The wake-up call volume increases over time (fixed setting).

Deactivating the wake-up call/repeating after a pause (snooze mode)

Prerequisite: A wake-up call sounds on the handset.

- ▶ **Deactivate:** Touch **Off**.

Or:

- ▶ **Snooze mode:** Touch **Snooze**. The wake-up call is repeated after 5 minutes. After the second repetition the wake-up call is deactivated for at least 24 hours.

Baby phone call

When the baby phone is switched on, the stored (internal or external) destination number is called as soon as a defined noise level is exceeded in the vicinity of the handset.

A baby phone call to an external destination number is cancelled after approximately 90 seconds (= time for connection to be set up + duration of the connection). The baby phone call to an internal number is cancelled after approx. 3 minutes (depending on the base). During a baby phone call, the accept call and menu keys of the baby phone call handset are locked and the loudspeaker is deactivated.

Incoming calls are signalled only via the display, the lighting is reduced to 50%. Vibration alarm, ring tones, advisory tones and paging are switched off.





If you accept an incoming call, the baby phone call mode is suspended for the duration of the call, but the function **remains** activated.

The baby phone call is not deactivated by switching the handset off and on again.

Caution

- ◆ **Always check the function when switching on (noise sensitivity, connection to an external number). Please note that the baby phone call is only activated 20 seconds after being switched on.**
- ◆ Place the handset **in the charger** cradle so that the front with the microphone is facing the baby and the distance between the handset and the baby is no more than 1 to 2 metres.
- ◆ No answering machine may be activated at the destination number.

Changing the settings

- ▶ Menu key \bigcirc ▶ [ Room Monitor] ▶ Touch [ Edit] ▶ Select the sensitivity (**High** or **Low**) and destination of the babyphone call (**Internal** or **External**).
- ▶ Next to **Number** touch  ▶ Enter the destination number or select the internal participant.
- ▶ Confirm with  ▶ Touch [ Save].

Activating/deactivating the baby phone call

- ▶ **Switch on:** Menu key \bigcirc ▶ [ Room Monitor] ▶ Touch the key on the right.
- ▶ **Switch off:** On the handset on which the baby phone call is activated, touch the key on the left.

Cancelling the baby phone call

- ▶ During a baby phone call, touch .

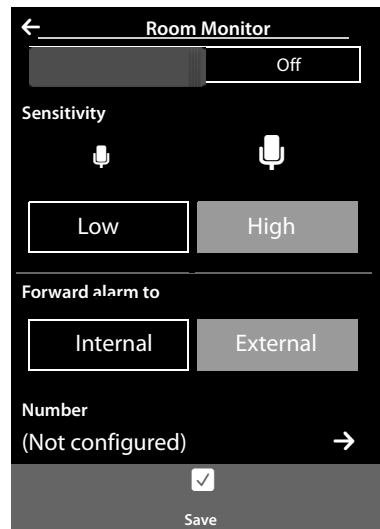



Accepting the baby phone call

- ▶ On the destination phone/handset of the alarm call, press the pick-up key  or pick up the receiver.

Deactivating the baby phone call remotely

Prerequisites: The destination of the baby phone call is an external number. The recipient's phone supports tone dialling (MFV).

- ▶ Accept the baby phone call and touch the   keys.

The call is ended. The baby phone call is deactivated and the handset is in idle mode.



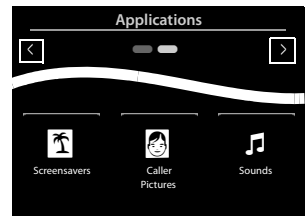

Screensaver, caller pictures and sounds

Mono/polyphonic sounds/ring tones and pictures are saved on the handset (and can be selected as screensavers or caller pictures). You can load additional pictures and sounds onto the handset from your PC (→ Gigaset QuickSync, page 68).

On the menu page **Applications** you will find the media pools **Screensavers**, **Caller Pictures** and **Sounds**, with which you can manage the pictures and sounds saved on your telephone.



Viewing/deleting pictures

- ▶ Menu key  ▶ [ Screensavers] / [ Caller Pictures] ▶ Drag your finger from right to left or left to right over the display to view the individual pictures.
- ▶ **Delete picture:** Scroll to the picture ▶ Touch [ Delete] ▶ Confirm with **Yes**.

Playing back sounds

- ▶ Menu key  ▶ Touch [ Sounds] ▶ Select a sound.

SMS (text messages)

The following prerequisites must be satisfied if you wish to use the SMS function.

Prerequisites:

- ◆ Calling Line Identification is enabled.
- ◆ Your network provider supports SMS within the fixed line network.
- ◆ You have entered the telephone number of at least one SMS centre (→ [page 66](#)).
- ◆ To receive SMS messages, you must be registered with your network provider.
This usually occurs automatically when you send your first text message.

Writing and sending text messages

Your system can send a **linked SMS** (made from up to four individual SMS messages) as one message. The messages are linked automatically.

- ▶ **Write SMS:** Menu key ▶ [**Write Text Message**] ▶ Touch the **To** field ▶ Enter recipient number **with prefix** ▶ Confirm with ▶ Touch the **Message** field ▶ Enter SMS text (enter text and special characters, → [page 28](#)) ▶ Confirm with .
- ▶ **Send SMS:** Touch [→ **Send**].

Please note

- ◆ If the SMS text can no longer be displayed in full, a scroll bar is displayed to the right of the text field with which you can scroll up and down within the text.
- ◆ Position the cursor within the text: touching the left half of a word will position the cursor and hence the new text in front of this word. Touching the right half of the word will position the cursor and hence the new text after this word.
- ◆ In the case of an external call, or if you interrupt writing by more than 3 minutes, the text is automatically saved in the draft message list. If the memory is full, the SMS is deleted.
- ◆ **Sending SMS messages can result in additional costs.** Please consult your provider.

Storing SMS messages temporarily (drafts list)

You can store SMS messages temporarily and then change and send them later.

- ▶ Touch to end text input ▶ Touch [**Save**].

Opening an SMS from the draft message list

- ▶ Menu key ▶ [**Write Text Message**] ▶ [**Drafts**] ▶ Touch the entry in the draft list.

You can delete the SMS ([**Delete**]) or continue writing ([**Edit**]).

Receiving an SMS

Incoming SMS messages are saved in the inbox; linked SMS messages are, in general, displayed as **one** SMS.

Activating/deactivating first ring tone muting

Every incoming SMS is signalled by a single ring of the ring tone. If you accept a "call" of this type, the SMS is lost. To prevent this, suppress the first ring for all external calls.

- ▶ Menu key ▶ Menu page **Settings** ▶ Enter the number code for the service functions (→ page 70).
- ▶ If the first ring is to be muted, enter: .
- ▶ If the first ring should **not** be muted, enter: .

SMS inbox

The inbox contains all the received SMS messages and any SMS messages that could not be sent due to an error.

If the SMS inbox contains messages (read or unread), the following icon appears on the message page (→ page 20):

- ▶ Touch the icon to open the SMS inbox.

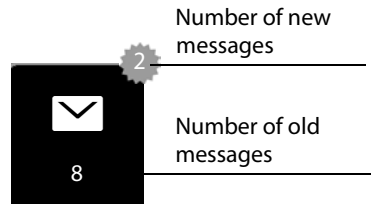

Reading and managing SMS messages

- ▶ **Open the detail view:** Next to the SMS entry, touch

You have the following options:

- ◆ Press : Call the sender of the SMS.
- ◆ [**Reply**]: Write and send an SMS to the sender.
- ◆ [**Edit**]: Change the SMS text and send back to the sender (→ page 64).
- ◆ [**Delete**]: Delete SMS.
- ◆ **Touch sender/number in the message text**

Call the number or save in Contacts (→ page 56).

The number cannot be divided by a space. If it contains a special character (+ - / etc.), it is regarded as two numbers. An attached mailbox identifier is added to Contacts.

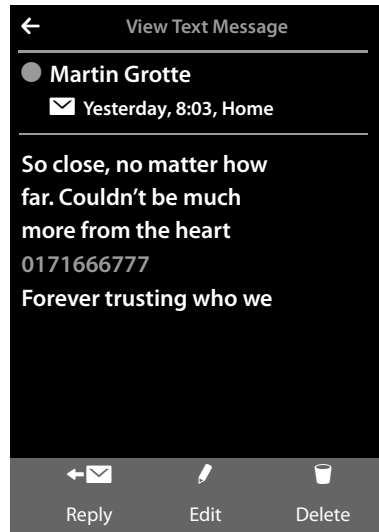

Delete the entire contents of SMS inbox and drafts list:

- ▶ Menu key ▶ Menu page **Settings**
 - ▶ [**System**] ▶ (Scroll if necessary) ▶ Next to **Clean-up List** touch ▶ Touch **Text Messages** next to ▶ Confirm with **Yes**.



Setting up the SMS centre





If you wish to use the SMS function, you must have saved the telephone number of at least one SMS centre in the device.

- ▶ Check **Active Send Centre**: ▶ Menu key  ▶ Menu page **Settings**
▶ [ **SMS Service Centres**]

Ask your service provider for the telephone number of an SMS centre.

SMS messages are received from **every** entered SMS centre as long as they are registered with their service provider. Your SMS messages are sent via the SMS service centre that is entered as the active send centre.

Entering/changing the SMS centre, setting the send centre

- ▶ Menu key  ▶ Menu page **Settings** ▶ [ **SMS Service Centres**] ▶ Next to an SMS centre, touch  ▶ Enter the telephone number of the SMS centre ▶ Confirm with .
- ▶ If necessary, repeat the procedure for the other SMS centres.
- ▶ **Specify Active Send Centre**: Touch the number of the SMS centre (1–4) you wish to use as the send centre at the top of the display. For the SMS centres 2 to 4, the setting only applies to the next SMS.

Please note

If you have agreed a flat fixed line network rate with your network operator, the chargeable numbers with dialling code 0900 are often blocked. If, in this case, you enter a 0900 number for the SMS service centre, you will not be able to send text messages from your phone.







SMS on a PABX

- ◆ **Calling line identification** must be forwarded to the extension of the PABX (**CLIP**).
- ◆ If necessary, the access code must be prefixed to the number of the SMS centre (depending on your PABX).
Test: Send an SMS to your own number, once with the access code and once without the access code.
- ◆ If the SMS is sent without the extension number, it will not be possible for the recipient to answer directly.

Sending and receiving SMS on ISDN PABXs is only possible via the MSN number assigned to your base.

Activating/deactivating SMS function

When you switch off your phone you cannot send or receive any further SMS messages. All the settings and the entries in the inbox and draft message list remain saved even after switching off.

- ▶ Menu key  ▶ Menu page **Settings** ▶ Enter the number code for the service functions (→ page 70).
- ▶ Deactivate the SMS function: Enter   .
- ▶ Reactivate the SMS function (default): Enter   .

SMS troubleshooting

| | |
|----|---|
| EO | Calling Line Identification permanently restricted (CLIR) or Calling Line Identification not activated. |
| FE | Error occurred during SMS transfer. |
| FD | Connection to SMS centre failed, see self-help. |

Self-help with errors

You cannot send messages.

1. You have not requested the CLIP service (Calling Line Identification Presentation).
 - ▶ Ask your network provider to enable the feature.
2. SMS transmission has been interrupted (e.g., by a call).
 - ▶ Resend the text message.
3. The network provider does not support this feature.
4. No number or an incorrect one has been entered for the send centre.
 - ▶ Enter the number (→ [page 66](#)).

You receive an incomplete SMS.

1. Your phone's memory is full.
 - ▶ Delete old SMS messages.
2. The network provider has not yet sent the rest of the message.

The SMS message is played back.

1. The "display call number" service is not activated.
 - ▶ Ask your network provider to enable this feature (there is a charge for this).
2. Your mobile phone operator and SMS service provider are not working together.
 - ▶ Obtain information from your SMS service provider.
3. The phone is not registered with the SMS service provider.
 - ▶ Send an SMS message to register your phone to receive SMS messages.

Synchronising with your PC (Gigaset QuickSync)

You can:

- ◆ Synchronise your handset's Contacts list with your Google contacts online via the cloud
- ◆ Synchronise the Contacts on your handset with your PC's Outlook directory.
- ◆ Load caller pictures to the handset from the PC.
- ◆ Download pictures as a screensaver from the PC to the handset.
- ◆ Download sounds (ring tones) from the PC to the handset.
- ◆ Make outgoing calls and accept incoming calls. The display on the handset behaves in the same way as if the call were being handled directly on the handset.
- ◆ Update the firmware of your Gigaset SL910 handset (via USB only).

You can save the following image and sound formats on your handset:

| Sound | Format | Picture | Format |
|-----------------------------------|---------------------------|-----------------------------------|---|
| - Ring tones - Imported sounds | Internal WMA, MP3, WAV | - Caller picture - Screensaver | BMP, JPG, GIF 320 x 225 pixels 320 x 480 pixels |

To enable your handset to communicate with a PC, the **"Gigaset QuickSync" program (Version 7 or higher)** must be installed on your PC (free download and more information at www.gigaset.com/gigasetSL910).

You can use this program to create a connection between PC and handset via Bluetooth (→ page 1) or USB (→ page 50).

Please note

- ◆ Firmware can only be updated via a USB connection.
- ◆ If the USB data cable is plugged in, a Bluetooth connection cannot be established. If it is plugged in during an existing Bluetooth connection, this is cancelled.

A detailed description can be found in the **Gigaset QuickSync** help file.

Connecting the base station to the PABX

To find out which settings are required for your PABX, please refer to the PABX user guide.

You cannot send or receive SMS messages on PABXs that do not support Calling Line Identification.

Recall

- ▶ Menu key ▶ Menu page **Settings** ▶ [**Telephony**].
- ▶ Next to **Recall** touch ▶ Select flashing time (= set value).

Saving an access code (outside line code)

If you have to enter an access code before any external number on your PABX, e.g., "0":

- ▶ Menu key ▶ Menu page **Settings** ▶ [**Telephony**] ▶ Next to **Access Code** touch
 - ▶ Enter the access code (max. 3-digit) and confirm with
- ▶ Next to **Use** touch ▶ Select one of the following values (= set value):
 - **Never:** Deactivate access code.
 - **Calls from Call Lists:** The access code should only be prefixed when dialling from a list (SMS, calls, answering machine (Gigaset SL910A)).
 - **All Calls:** The access code should be prefixed to every number.

Setting pauses

- ▶ Menu key ▶ Menu page **Settings** ▶ Enter the number code for the service functions (→ [page 70](#)) ▶ Then enter one of the following function-specific codes
 - **Pause after line seizure:**
 for 1 second, for 3 seconds or for 7 seconds.
 - **Pause after R key:**
 for 800 ms, for 1600 ms or for 3200 ms
 - **Dialling pause** (pause after access code):
 for 1 second, for 2 seconds, for 3 seconds or for 6 seconds.
- Add dial pause during dialling:**
 Press and hold for 2 seconds on the keypad. A P appears in the display.

Configuring service functions

Your telephone does not offer certain **service functions** (e.g., for connecting to a PABX) via the menu.

Start service function:

- ▶ Menu key **O** ▶ Menu page **Settings** ▶ Mentally assign the numbers 1 to 9 to the first 9 icons on the menu page in lines (see illustration below).

(Example):

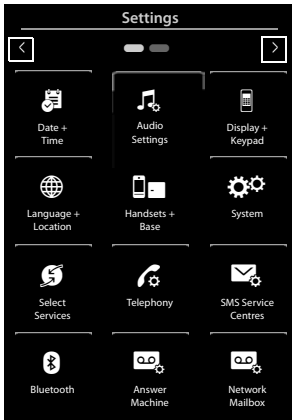

i.e.:

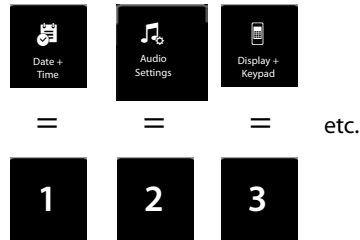



























The numbers are **not** shown in the display! They were positioned here above the menu icons for better understanding.

















- ▶ Enter a number code: Sequentially press and **hold** (for approximately 2 seconds) the following icons relating to the numbers: **1 4 7 2 3 6 5 9 8**.
- ▶ A number field opens which you can use to enter a function-specific code.

Display icons

Options bar icons

The following functions are available in the options bar depending on the operating situation.

| Icon | Action |
|---|--|
|  | Activate speaker mode |
|  (orange) | (Speaker mode is activated) Deactivate speaker mode |
|  | Speaker profile |
|  | Mute handset microphone |
|  (orange) | Unmute handset microphone |
|  | Deactivating the ring tone |
|  | Setting the volume |
|  | Open call lists |
|  | Opening Contacts |
|  | Accept number in Contacts |
|  | Create SMS |
|  | Sending an SMS |
|  | Reply to SMS |
|  | Opening the draft list |
|  | Deregistering the handset |
|  | Open list of internal callers/make internal call |
|  | Create new Contacts entry |
|  | Initiating a consultation call: |
|  | Initiate/end three-way conference call |
|  | Speed dial |
|  | Copy list |
|  | Copy entry |
|  | Editing entries |
|  | Show keypad |
|  | Determine free memory in the media pool |
|  | Search |
|  | Skip settings |

| Icon | Action |
|--|---|
|  | Deleting |
|  | Save/select |
|  | Enter new appointment |
|  | Calendar: Set selected date to Today |
|  | Change order (sort by last name or first name) |
|  | Contacts entry: Delete caller ring tone assignment |
|  | Contacts entry: Delete caller picture assignment |
|  | Delete birthday |
|  | Trust Bluetooth device found |
|  | Divert call to answering machine |
|  | Play messages |
|  (red) | Recording an announcement |
|  | Stop recording |
|  | During message playback: Go back five seconds |
|  (green) | Accepting a waiting call |
|  (red) | Reject a waiting call |

Please note

The menu icons can be found in the menu overview on [page 73](#).

Display icons

Icons in the status bar

The following icons are displayed in the status bar depending on the settings and the operating status of your telephone:

| Icon | Meaning |
|------|--|
| | Signal strength (No Radiation off) |
| | 76%–100% |
| | 51%–75% |
| | 26%–50% |
| | 1%–25% |
| | Red: no connection to the base |
| | No Radiation activated: white if Max. Range is on; green if Max. Range is off |
| | Answering machine activated (SL910A only) |
| | Bluetooth activated |
| | Bluetooth headset/data device connected |
| | Ring tone deactivated |
| | Alarm switched on and wake-up time set |

| Icon | Meaning |
|------|--|
| | Battery charge status: |
| | White: charged over 66% |
| | White: charged between 34% and 66% |
| | White: charged between 11% and 33% |
| | Red: charged below 11% |
| | Flashing red: battery almost empty (less than 10 minutes talk time) |
| | Battery charging (current charge status): |
| | 0%–10% |
| | 11%–33% |
| | 34%–66% |
| | 67%–100% |

Signalling display icons



Establishing a connection
(outgoing call)



Connection established



Connection cannot be established/
connection terminated



Internal/external
call



Alarm call



Reminder call for appointment/
birthday



Answering machine
is recording

Other display icons



Information



(Security)
prompt



Please wait...



Action complete
(green)



Warning



Action failed
(red)



Setting options

Open the **Settings** menu page:

- ▶ Briefly press menu key **O** when the handset is in idle mode.
- ▶ Drag your finger horizontally across the display to switch to the **Settings** menu page.

Please note

Not all of the functions described in this user guide are available in all countries.

| Main menu Settings | Submenu Current setting | Additional setting options | Page |
|--|----------------------------|---|---------|
|  Date + Time | Time | Time Time Format 24 hrs 12 hrs | page 9 |
| | Date | Date Date Order | |
|  Audio Settings | Ringtones Int Ext | Volume Crescendo Int. Calls Ext. Calls Time Ctrl (Ringer Off) Anon. Call Silenc. | page 35 |
| | Silent Alert | | |
| | Reminder Signal | Volume Crescendo Sound | |
| | Advisory Tones | | |
| | Confirmations | | |
| | Battery Warning | | |
| | Music on Hold | | |

Setting options

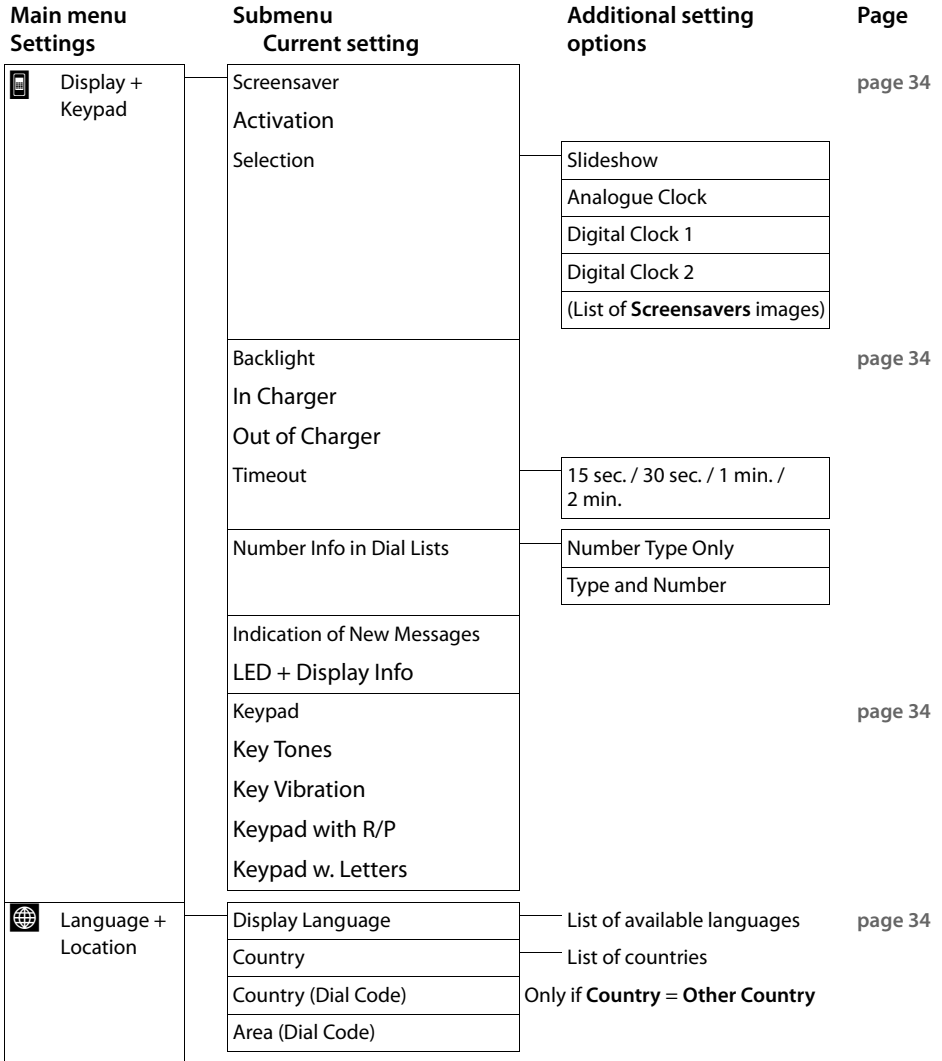



**Main menu
Settings**





**Submenu
Current setting**



**Additional setting
options**

Page

| | | | |
|--|--|---|---------|
|  Handsets + Base | This Handset Register De-register Rename | | page 46 |
| | Registered Handsets (List of registered handsets) | (Only if more than one handset is registered) | page 47 |
| | Connected to Base | Base 1 | page 46 |
| | | : | |
| | | Base 4 | |
| | | Best Base | |
|  System | ECO DECT | | page 39 |
| | Max. Range | | |
| | No Radiation | | |
| | Repeater Mode | | page 37 |
| | Security Check | | page 38 |
| | System PIN | | |
| | Resets | | page 38 |
| | Handset Reset | | |
| | Base Reset | | |
| | Clean-up List | Appointments | page 22 |
| | All Past Appointments | | |
| | Calls | | |
| | Missed Calls | | |
| | Accepted Calls | | |
| | Outgoing Calls | | |
| | Messages | | |
| | Text Messages | | |
| | Answer Machine | | |
| | Contacts | | |

Setting options

| Main menu Settings | Submenu Current setting | Additional setting options | Page |
|--|--|--|---|
|  System | Only with base variant 2 (even after firmware update) Local Network 192.168.2.2 (Current IP address) Firmware Update | IP Address Type Static Dynamic IP Address Subnet Mask Default Gateway Preferred DNS server Automatic Check Update Firmware | |
| |  Telephony | Auto Answer Listening In Access Code Use Recall | Never Calls from Call Lists All Calls 80 ms/.../800 ms |
|  SMS Service Centres | Active Send Centre Service Centr. 1 : Service Centr. 4 | | |
|  Bluetooth | Own Device Known Devices Activation Devices found (only if Activation = on) | Device Name | page 50 |

| Main menu Settings | Submenu Current setting | Additional setting options | Page | |
|---|--|--|-------------------|---------|
|  Answer Machine | Activation (Gigaset SL910A) Mode Announcement Advisory Message Time Control | | page 41 | |
| | Announcement from: Advisory Message from: | Only if Time Control is switched on | | |
| | Announcement | Current Announcement Default User recorded | page 41 | |
| | Advisory Message | Current Message Default User recorded | page 41 | |
| | Recording Length | 1 min. / 2 min. / 3 min. Maximum | page 42 | |
| | Recording Quality | Excellent Long Play | | |
| | Ring Delay | No Delay 10 sec. / 18 sec. / 30 sec. Automatic | | |
| | Call Screening | | page 42 | |
| | Play Time Stamp | | | |
| |  Network Mailbox | On / Off | Provider-specific | page 45 |
| | | Access Number | | |

Customer service & product warranty – Australia and New Zealand

IMPORTANT

Please retain your sales receipt as proof of the date of purchase.

Customer Service

If you require assistance in operating this product please contact us

AUS: 1300 780 878 or by e-mail at the Customer Care section of our website at www.gigaset.com/au

NZ: 0800 780 878 or by e-mail at the Customer Care section of our website at www.gigaset.com/au

If you are trying to access a Network Service and require assistance specifically related to the network service or would like to subscribe to the service, contact your service provider.

Product Warranty

Our goods come with guarantees that cannot be excluded under the Australian Consumer Law. You are entitled to a repair or replacement for a major failure and for compensation for any other reasonably foreseeable loss or damage. You are also entitled to have the goods repaired or replaced if the goods fail to be of acceptable quality and the failure does not amount to a major failure.

Subject to the conditions stated in this Product Warranty Section, this product, excluding battery and accessory devices, is guaranteed against any defect in materials or workmanship under conditions of normal use for a period of 12 months from date of purchase (Product Warranty).

The benefits conferred by this warranty are in addition to other warranties and remedies that are implied under the Australian Trade Practices Act and similar Country, State and Territory laws (Statutory Rights). For New Zealand customers, this warranty is in addition to statutory rights observed under New Zealand Legislation.

Subject to your Statutory Rights, the goods will not be eligible for service under this warranty if:

- 1 Proof of purchase cannot be provided;
- 2 The defect was caused by an accident, misuse, abuse, improper installation or operation, vermin infestation, lack of reasonable care, unauthorised modification, loss of parts, tampering or attempted repair by a person not authorised by Gigaset; or
- 3 The product has been damaged by lightning or a mains power surge.
- 4 The Phone was not imported into Australia by Gigaset Communications GmbH.

To obtain service during the terms of this warranty and/or to claim warranty call the Information Line on

AUS: 1300 780 878 or by e-mail at the Customer Care section of our website at www.gigaset.com/au

NZ: 0800 780 878

If it is necessary to have the product serviced, the customer service representative will inform you of the product return process. If it is necessary to have the product serviced under warranty in both Australia and New Zealand you will need to return the product to your place of purchase. If this is not possible please call the relevant Technical Support line listed in this document whereby the customer service representative will inform you of the product return process. Except as explicitly stated in this document, all other expenses with regard to claiming Product Warranty shall be borne by you.

Please ensure that:

- 1 You provide proof of purchase;
- 2 Your product is suitably packaged; and
- 3 You have included all components from the original purchase.

In Australia and New Zealand the product will be serviced within ten business days after the defective product is received by the authorised agent.

Any and all warranty services referred to under this Product Warranty will be provided

- ▶ In **Australia** by CommsPlus Distribution, Unit 3a, 100 Station Street, Nunawading, Victoria, 3131 Phone: **1300 780 878**, and
- ▶ in **New Zealand** by Atlas Gentech (NZ) Limited, 76 Carbine Road, Mt Wellington, Auckland 1741 Phone: **0800 780 878**.

Subject to your Statutory Rights:

- 1 Any claim under this warranty is limited to the cost of repair or replacement of the product; and
- 2 If the goods are found to be in sound working order by the authorised service centre, you may be charged a fee for service and for any other direct costs associated with having the product delivered for service.

Replacement or repair services are only offered for products purchased in Australia and New Zealand that bear Gigaset Communications GmbH local registered N Number and Telepermit markings.



Please have your proof of purchase ready when calling.

IMPORTANT NOTICE:

Under power failure conditions, this telephone may not operate.
Please ensure that a separate telephone, not dependent upon local power, is available for emergency use.



Questions and answers

If you have any queries about the use of the telephone, suggested solutions are available on the Internet at

www.gigaset.com/service

▶ FAQ ▶ First steps for troubleshooting

The table below also lists steps for troubleshooting.

| |
|--|
| <p>Registration or connection problems with a Bluetooth headset.</p> <ul style="list-style-type: none">▶ Reset the Bluetooth headset (see the user guide for your headset).▶ Delete registration data from the handset when de-registering the device (→ page 51).▶ Repeat the registration process (→ page 50). |
| <p>There is nothing on the display and the display does not react when you touch it.</p> <ol style="list-style-type: none">1. The handset is not activated.<ul style="list-style-type: none">▶ Press and hold .2. The battery is flat.<ul style="list-style-type: none">▶ Charge or replace the battery (→ page 8).3. The keypad and display lock is activated.<ul style="list-style-type: none">▶ Press and hold the menu key . |
| <p>"Base connection lost - Searching for base ... " flashes on the display.</p> <ol style="list-style-type: none">1. The handset is outside the range of the base.<ul style="list-style-type: none">▶ Move the handset closer to the base.2. The base is not activated.<ul style="list-style-type: none">▶ Check the base power adapter (→ page 6).3. The base's range is reduced because Eco Mode is activated.<ul style="list-style-type: none">▶ Deactivate Eco Mode (→ page 39) or reduce the distance between the handset and the base. |
| <p>"Handset not registered to any base" flashes on the display.</p> <p>The handset has not yet been registered or was de-registered because an additional handset was registered (more than six DECT registrations).</p> <ul style="list-style-type: none">▶ Register the handset again (→ page 46). |
| <p>The handset does not ring.</p> <ol style="list-style-type: none">1. The ring tone is deactivated.<ul style="list-style-type: none">▶ Activate the ring tone (→ page 36).2. The phone does not ring if the caller has withheld his number.<ul style="list-style-type: none">▶ Activate the ring tone for unknown calls (→ page 37).3. Telephone does not ring in a certain period of time.<ul style="list-style-type: none">▶ Time control for external calls is activated (→ page 37). |
| <p>You cannot hear a ring tone/dialling tone from the fixed line.</p> <p>The phone cord supplied has not been used or has been replaced by a new cord with the wrong pin connections.</p> <ul style="list-style-type: none">▶ Please always use the phone cord supplied or ensure that the pin connections are correct when purchasing from a retailer (→ page 85). |
| <p>Error tone sounds after system PIN prompt.</p> <p>You have entered the wrong system PIN.</p> <ul style="list-style-type: none">▶ Repeat the process, if necessary reset the system PIN to 0000 (→ page 38). |
| <p>Forgotten system PIN.</p> <ul style="list-style-type: none">▶ Reset the system PIN to 0000 (→ page 38). |

The other party cannot hear you.

The handset is "muted".

- ▶ Unmute the microphone (→ page 31).

The caller's number is not displayed.

1. **Calling Line Identification (CLI)** is not enabled for the caller.
 - ▶ The caller should ask his network provider to enable Calling Line Identification (CLI).
2. **Calling line display (CLIP)** is not supported by the network provider or has not been enabled for you.
 - ▶ Have calling line display (CLIP) enabled by your network provider.
3. Your telephone is connected via a PABX or a router with an integrated PABX (gateway) that does not transmit all information.
 - ▶ Reset the system: briefly pull out the power plug. Reinsert the plug and wait until the device restarts.
 - ▶ Check the settings on the PABX and activate phone number display, if necessary. To do this, search for terms such as CLIP, calling line identification, phone number identification, caller ID etc. in the system's user guide or ask the system manufacturer.

You hear an error tone when keying an input.

Action has failed/invalid input.

- ▶ Repeat the process.
- ▶ Read the display and refer to the user guide if necessary.

You cannot listen to messages on the network mailbox.

Your PABX is set to pulse dialling.

- ▶ Set your PABX to tone dialling.

Gigaset SL910A only:

No time is specified for a message in the call list.

Date/time are not set.

- ▶ Set the date/time (→ page 9).

The answering machine reports "Invalid PIN" during remote operation.

1. You have entered the wrong system PIN.
 - ▶ Enter the system PIN again.
2. The system PIN is still set to 0000.
 - ▶ Set the system PIN to something other than 0000 (→ page 38).

The answering machine is not recording any messages/has switched to the advisory message.

The memory is full.

- ▶ Delete old messages.
- ▶ Play back new messages and delete.

Check base/handset service information

You will need the service information if you call our hotline.

Base service information:

Prerequisite: You are trying to establish an external call or are conducting an external call.

- ▶ **Briefly** touch any point in the status bar to show the required service information in the display.

Handset service information:

Prerequisite: A call is not in progress.

- ▶ **Briefly** touch any point in the status bar and then touch **Show Service Info**.

Exclusion of liability

The display on your handset has a resolution of 480x320 pixels, which is achieved with the aid of 460,800 control elements. Each pixel consists of three subpixels (red, green, blue).

It may be the case that a pixel is incorrectly controlled or has a colour deviation. **This is normal and no reason for a warranty claim.**

The following table shows the number of pixel errors that may occur without leading to a warranty claim.

| Description | Maximum number of permitted pixel errors |
|---|--|
| Colour illuminated subpixels | 1 |
| Dark subpixels | 1 |
| Total number of coloured and dark subpixels | 1 |

Please note

Signs of wear on the display and housing are excluded from the warranty.

Environment

Our environmental mission statement

We, Gigaset Communications GmbH, bear social responsibility and are actively committed to a better world. Our ideas, technologies and actions serve people, society and the environment. The aim of our global activity is to secure sustainable life resources for humanity. We are committed to a responsibility for our products that comprises their entire life cycle. The environmental impact of products, including their manufacture, procurement, distribution, utilisation, service and disposal, are already evaluated during product and process design.

Further information on environmentally friendly products and processes is available on the Internet at www.gigaset.com.

Environmental management system



Gigaset Communications GmbH is certified pursuant to the international standards ISO 14001 and ISO 9001.

ISO 14001 (Environment): Certified since September 2007 by TÜV SÜD Management Service GmbH.

ISO 9001 (Quality): Certified since 17/02/1994 by TÜV SÜD Management Service GmbH.

Disposal

Batteries should not be disposed of in general household waste. Observe the local waste disposal regulations, details of which can be obtained from your local authority or the dealer you purchased the product from.

All electrical and electronic equipment must be disposed of separately from general household waste using the sites designated by local authorities.



The appropriate disposal and separate collection of used equipment serve to prevent potential harm to the environment and to health. They are a precondition for the re-use and recycling of used electrical and electronic equipment.

For further information on disposing of your used equipment, please contact your local authority or your refuse collection service.

Appendix

Care

Wipe the device with a **damp** cloth or an antistatic cloth. Do not use solvents or microfibre cloths.

Never use a dry cloth; this can cause static.

In rare cases, contact with chemical substances can cause changes to the device's exterior. Due to the wide variety of chemical products available on the market, it was not possible to test all substances.

Impairments in high-gloss finishes can be carefully removed using display polishes for mobile phones.

Contact with liquid

If the device comes into contact with liquid:

- 1 **Disconnect the power supply.**
- 2 **Remove the batteries and leave the battery compartment open.**
- 3 Allow the liquid to drain from the device.
- 4 Pat all parts dry.
- 5 Place the device in a dry, warm place **for at least 72 hours (not in a microwave, oven etc.)** with the battery compartment open and the keypad facing down (if applicable).
- 6 **Do not switch on the device again until it is completely dry.**

When it has fully dried out, you will normally be able to use it again.

Specifications

Battery

Technology: Lithium ion (Li-Ion):

Voltage: 3.7 V

Capacity: 1000 mAh

Type: V30145-K1310-X447

Due to the constant progression in battery development, the list of recommended batteries in the FAQ section of the Gigaset Customer Care pages is updated regularly:

www.gigaset.com/service

Handset operating times/charging times

The operating time of your Gigaset depends on the capacity and age of the battery and the way it is used. (All times are maximum possible times.)

| | |
|---|-----|
| Standby time (hours) * | 200 |
| Standby time in Eco mode+ (hours) * | 130 |
| Talktime (hours) | 14 |
| Operating time for 1.5 hours of calls per day (hours) * | 106 |
| Operating time in Eco mode+ for 1.5 hours of calls per day (hours) * | 75 |
| Charging time in charger cradle (hours) | 5 |

* Without display backlight

Information about the USB port

- ◆ The handset's battery is charged using a USB connection with a power supply of 500 mA.
- ◆ **On USB connections with lower charging currents, the consumption of the handset itself may be greater than the recharging. In this case, the battery charge decreases.**

Base power consumption

| | | |
|-----------------|---------------|---------------|
| | SL910 | SL910A |
| In standby mode | Approx. 1.1 W | Approx. 1.2 W |
| During a call | Approx. 1.2 W | Approx. 1.3 W |

General specifications

DECT

| | |
|--|--|
| DECT standard | Supported |
| GAP standard | Supported |
| No. of channels | 60 duplex channels |
| Radio frequency range | 1880 – 1900 MHz |
| Duplex method | Time division multiplexing, 10 ms frame length |
| Repeat frequency of the transmission pulse | 100 Hz |
| Length of the transmission pulse | 370 μ s |
| Channel grid | 1728 kHz |
| Bit rate | 1152 kbit/s |
| Modulation | GFSK |
| Language code | 32 kbit/s |
| Transmission power | 10 mW average power per channel, 250 mW pulse power |
| Range | Up to 50 m in buildings, up to 300 m outdoors |
| Base power supply | 230 V ~/50 Hz |
| Ambient conditions for operation | +5°C to +45°C, 20% to 75% relative humidity |
| Dialling mode | DTMF (tone dialling) |

Bluetooth

| | |
|-----------------------|------------------|
| Radio frequency range | 2402–2480 MHz |
| Transmission power | 1 mW pulse power |

Pin connections on the telephone jack

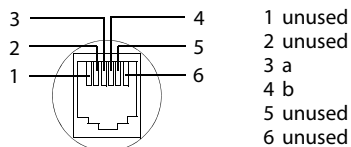

Accessories

Upgrade your Gigaset to a cordless PABX:

Gigaset SL910H handset

Full compatibility only available with firmware update (from version 100) approx. November/December 2012.

- ◆ Innovative touchscreen operating concept
- ◆ Handset with real metal frame
- ◆ 8.1 cm TFT colour display
- ◆ Brilliant sound quality in handsfree mode
- ◆ Bluetooth® and mini USB
- ◆ Individual menu configuration
- ◆ Contacts capacity for 500 vCards
- ◆ Talk/standby time of up to 13 h/180 h
- ◆ Brilliant sound quality in handsfree mode with 4 adjustable handsfree profiles
- ◆ Caller pictures, screensaver (analogue and digital clock)
- ◆ Download ring tones
- ◆ ECO-DECT
- ◆ Alarm
- ◆ Calendar with appointment scheduler
- ◆ Night mode with time-controlled ring tone deactivation
- ◆ No interruptions from anonymous calls
- ◆ Baby phone call
- ◆ SMS with up to 640 characters

www.gigaset.com/gigasetSL910h



Gigaset S820H handset

- ◆ Brilliant sound quality in handsfree mode
- ◆ Illuminated keypad
- ◆ Side key for simple volume control
- ◆ 2.4" touchscreen
- ◆ Bluetooth® and mini USB
- ◆ Contacts capacity for 500 vCards
- ◆ Talk/standby time of up to 20 h/250 h, standard batteries
- ◆ Brilliant sound quality in handsfree mode with 4 adjustable hands-free profiles
- ◆ Caller pictures, screensaver (analogue and digital clock)
- ◆ Download ring tones
- ◆ ECO-DECT
- ◆ Alarm
- ◆ Calendar with appointment scheduler
- ◆ Night mode with time-controlled ring tone deactivation
- ◆ No interruptions from anonymous calls
- ◆ Blacklist for 15 unwanted phone numbers (depending on base)
- ◆ Baby phone, direct call
- ◆ SMS with up to 640 characters

www.gigaset.com/gigasetS820h



L410 handsfree clip for cordless phones

- ◆ Complete freedom of movement when making calls
- ◆ Practical clip fastening
- ◆ Perfect sound quality in handsfree mode
- ◆ Simple call pickup from handset
- ◆ Weight approx. 30 g
- ◆ ECO-DECT
- ◆ 5 volume settings
- ◆ LED status display
- ◆ Talk/standby time of up to 5 h/120 h
- ◆ Ranges in buildings up to 50 m, outdoors up to 300 m

www.gigaset.com/gigasetL410



ZX600 Bluetooth headset

- ◆ Supports Bluetooth® 2.0 (headset and handsfree profile)
- ◆ Perfect voice quality
- ◆ Optimal wear comfort
- ◆ Weight approx. 15 g
- ◆ Talktime up to 7 h

www.gigaset.com/gigasetzx600



Gigaset repeater

The Gigaset repeater can be used to increase the reception range between your Gigaset handset and the base.

www.gigaset.com/gigasetrepeater



Compatibility

You can find more information about the handset functions in connection with the individual Gigaset bases at: www.gigaset.com/compatibility

All accessories and batteries are available from your phone retailer.



Use only original accessories. This will avoid possible health risks and personal injury, and also ensure compliance with all the relevant regulations.

Open Source software

General

Your Gigaset unit includes, among other things, Open Source software that is subject to various licence conditions. The granting of rights of use with regard to the Open Source software that go beyond the operation of the unit in the form produced by Gigaset Communications GmbH is regulated in the relevant licence conditions of the Open Source Software.

Licence and copyright information

Your Gigaset unit includes Open Source software which is subject to the GNU General Public License (GPL) or the GNU Lesser General Public License (LGPL). The corresponding licence conditions are printed at the end of this chapter in their original version. You can download the corresponding source code from the Internet at www.gigaset.com/opensource/. Within three years after the product is purchased, the corresponding source code can also be requested from Gigaset Communications GmbH. Please use the contact options specified at www.gigaset.com/service.

Licence texts

GNU GENERAL PUBLIC LICENSE

Version 2, June 1991

Copyright© 1989, 1991 Free Software Foundation, Inc., 51 Franklin Street, Fifth Floor, Boston, MA 02110-1301 USA

Everyone is permitted to copy and distribute verbatim copies of this license document, but changing it is not allowed.

Preamble

The licenses for most software are designed to take away your freedom to share and change it. By contrast, the GNU General Public License is intended to guarantee your freedom to share and change free software—to make sure the software is free for all its users. This General Public License applies to most of the Free Software Foundation's software and to any other program whose authors commit to using it. (Some other Free Software Foundation software is covered by the GNU Lesser General Public License instead.) You can apply it to your programs, too.

When we speak of free software, we are referring to freedom, not price. Our General Public Licenses are designed to make sure that you have the freedom to distribute copies of free software (and charge for this service if you wish), that you receive source code or can get it if you want it, that you can change the software or use pieces of it in new free programs; and that you know you can do these things.

To protect your rights, we need to make restrictions that forbid anyone to deny you these rights or to ask you to surrender the rights. These restrictions translate to certain responsibilities for you if you distribute copies of the software, or if you modify it.

For example, if you distribute copies of such a program, whether gratis or for a fee, you must give the recipients all the rights that you have. You must make sure that they, too, receive or can get the source code. And you must show them these terms so they know their rights.

We protect your rights with two steps: (1) copyright the software, and (2) offer you this license which gives you legal permission to copy, distribute and/or modify the software.

Also, for each author's protection and ours, we want to make certain that everyone understands that there is no warranty for this free software. If the software is modified by someone else and passed on, we want its recipients to know that what they have is not the original, so that any problems introduced by others will not reflect on the original authors' reputations.

Finally, any free program is threatened constantly by software patents. We wish to avoid the danger that redistributors of a free program will individually obtain patent licenses, in effect making the program proprietary. To prevent this, we have made it clear that any patent must be licensed for everyone's free use or not licensed at all.

The precise terms and conditions for copying, distribution and modification follow.

TERMS AND CONDITIONS FOR COPYING, DISTRIBUTION AND MODIFICATION

0. This License applies to any program or other work which contains a notice placed by the copyright holder saying it may be distributed under the terms of this General Public License. The "Program", below, refers to any such program or work, and a "work based on the Program" means either the Program or any derivative work under copyright law: that is to say, a work containing the Program or a portion of it, either verbatim or with modifications and/or translated into another language. (Hereinafter, translation is included without limitation in the term "modification".) Each licensee is addressed as "you".

Open Source software

Activities other than copying, distribution and modification are not covered by this License; they are outside its scope. The act of running the Program is not restricted, and the output from the Program is covered only if its contents constitute a work based on the Program (independent of having been made by running the Program). Whether that is true depends on what the Program does.

1. You may copy and distribute verbatim copies of the Program's source code as you receive it, in any medium, provided that you conspicuously and appropriately publish on each copy an appropriate copyright notice and disclaimer of warranty; keep intact all the notices that refer to this License and to the absence of any warranty; and give any other recipients of the Program a copy of this License along with the Program.

You may charge a fee for the physical act of transferring a copy, and you may at your option offer warranty protection in exchange for a fee.

2. You may modify your copy or copies of the Program or any portion of it, thus forming a work based on the Program, and copy and distribute such modifications or work under the terms of Section 1 above, provided that you also meet all of these conditions:

- a) You must cause the modified files to carry prominent notices stating that you changed the files and the date of any change.
- b) You must cause any work that you distribute or publish, that in whole or in part contains or is derived from the Program or any part thereof, to be licensed as a whole at no charge to all third parties under the terms of this License.
- c) If the modified program normally reads commands interactively when run, you must cause it, when started running for such interactive use in the most ordinary way, to print or display an announcement including an appropriate copyright notice and a notice that there is no warranty (or else, saying that you provide a warranty) and that users may redistribute the program under these conditions, and telling the user how to view a copy of this License. (Exception: if the Program itself is interactive but does not normally print such an announcement, your work based on the Program is not required to print an announcement.)

These requirements apply to the modified work as a whole. If identifiable sections of that work are not derived from the Program, and can be reasonably considered independent and separate works in themselves, then this License, and its terms, do not apply to those sections when you distribute them as separate works. But when you distribute the same sections as part of a whole which is a work based on the Program, the distribution of the whole must be on the terms of this License, whose permissions for other licensees extend to the entire whole, and thus to each and every part regardless of who wrote it.

Thus, it is not the intent of this section to claim rights or contest your rights to work written entirely by you; rather, the intent is to exercise the right to control the distribution of derivative or collective works based on the Program.

In addition, mere aggregation of another work not based on the Program with the Program (or with a work based on the Program) on a volume of a storage or distribution medium does not bring the other work under the scope of this License.

3. You may copy and distribute the Program (or a work based on it, under Section 2) in object code or executable form under the terms of Sections 1 and 2 above provided that you also do one of the following:

- a) Accompany it with the complete corresponding machine-readable source code, which must be distributed under the terms of Sections 1 and 2 above on a medium customarily used for software interchange; or,
- b) Accompany it with a written offer, valid for at least three years, to give any third party, for a charge no more than your cost of physically performing source distribution, a complete machine-readable copy of the corresponding source code, to be distributed under the terms of Sections 1 and 2 above on a medium customarily used for software interchange; or,
- c) Accompany it with the information you received as to the offer to distribute corresponding source code. (This alternative is allowed only for noncommercial distribution and only if you received the program in object code or executable form with such an offer, in accord with Sub-section b above.)

The source code for a work means the preferred form of the work for making modifications to it. For an executable work, complete source code means all the source code for all modules it contains, plus any associated interface definition files, plus the scripts used to control compilation and installation of the executable. However, as a special exception, the source code distributed need not include anything that is normally distributed (in either source or binary form) with the major components (compiler, kernel, and so on) of the operating system on which the executable runs, unless that component itself accompanies the executable.

If distribution of executable or object code is made by offering access to copy from a designated place, then offering equivalent access to copy the source code from the same place counts as distribution of the source code, even though third parties are not compelled to copy the source along with the object code.

4. You may not copy, modify, sublicense, or distribute the Program except as expressly provided under this License. Any attempt otherwise to copy, modify, sublicense or distribute the Program is void, and will automatically terminate your rights under this License. However, parties who have received copies, or rights, from you under this License will not have their licenses terminated so long as such parties remain in full compliance.

5. You are not required to accept this License, since you have not signed it. However, nothing else grants you permission to modify or distribute the Program or its derivative works. These actions are prohibited by law if you do not accept this License. Therefore, by modifying or distributing the Program (or any work based on the Program), you indicate your acceptance of this License to do so, and all its terms and conditions for copying, distributing or modifying the Program or works based on it.

6. Each time you redistribute the Program (or any work based on the Program), the recipient automatically receives a license from the original licensor to copy, distribute or modify the Program subject to these terms and conditions. You may not impose any further restrictions on the recipients' exercise of the rights granted herein. You are not responsible for enforcing compliance by third parties to this License.

7. If, as a consequence of a court judgment or allegation of patent infringement or for any other reason (not limited to patent issues), conditions are imposed on you (whether by court order, agreement or otherwise) that contradict the conditions of this License, they do not excuse you from the conditions of this License. If you cannot distribute so as to satisfy simultaneously your obligations under this License and any other pertinent obligations, then as a consequence you may not distribute the Program at all. For example, if a patent license would not permit royalty-free redistribution of the Program by all those who receive copies directly or indirectly through you, then the only way you could satisfy both it and this License would be to refrain entirely from distribution of the Program.

If any portion of this section is held invalid or unenforceable under any particular circumstance, the balance of the section is intended to apply and the section as a whole is intended to apply in other circumstances.

It is not the purpose of this section to induce you to infringe any patents or other property right claims or to contest validity of any such claims; this section has the sole purpose of protecting the integrity of the free software distribution system, which is implemented by public license practices. Many people have made generous contributions to the wide range of software distributed through that system in reliance on consistent application of that system; it is up to the author/donor to decide if he or she is willing to distribute software through any other system and a licensee cannot impose that choice.

This section is intended to make thoroughly clear what is believed to be a consequence of the rest of this License.

8. If the distribution and/or use of the Program is restricted in certain countries either by patents or by copyrighted interfaces, the original copyright holder who places the Program under this License may add an explicit geographical distribution limitation excluding those countries, so that distribution is permitted only in or among countries not thus excluded. In such case, this License incorporates the limitation as if written in the body of this License.

9. The Free Software Foundation may publish revised and/or new versions of the General Public License from time to time. Such new versions will be similar in spirit to the present version, but may differ in detail to address new problems or concerns.

Each version is given a distinguishing version number. If the Program specifies a version number of this License which applies to it and "any later version", you have the option of following the terms and conditions either of that version or of any later version published by the Free Software Foundation. If the Program does not specify a version number of this License, you may choose any version ever published by the Free Software Foundation.

10. If you wish to incorporate parts of the Program into other free programs whose distribution conditions are different, write to the author to ask for permission. For software which is copyrighted by the Free Software Foundation, write to the Free Software Foundation; we sometimes make exceptions for this. Our decision will be guided by the two goals of preserving the free status of all derivatives of our free software and of promoting the sharing and reuse of software generally.

NO WARRANTY

11. BECAUSE THE PROGRAM IS LICENSED FREE OF CHARGE, THERE IS NO WARRANTY FOR THE PROGRAM, TO THE EXTENT PERMITTED BY APPLICABLE LAW. EXCEPT WHEN OTHERWISE STATED IN WRITING THE COPYRIGHT HOLDERS AND/OR OTHER PARTIES PROVIDE THE PROGRAM "AS IS" WITHOUT WARRANTY OF ANY KIND, EITHER EXPRESSED OR IMPLIED, INCLUDING, BUT NOT LIMITED TO, THE IMPLIED WARRANTIES OF MERCHANTABILITY AND FITNESS FOR A PARTICULAR PURPOSE. THE ENTIRE RISK AS TO THE QUALITY AND PERFORMANCE OF THE PROGRAM IS WITH YOU. SHOULD THE PROGRAM PROVE DEFECTIVE, YOU ASSUME THE COST OF ALL NECESSARY SERVICING, REPAIR OR CORRECTION.

12. IN NO EVENT UNLESS REQUIRED BY APPLICABLE LAW OR AGREED TO IN WRITING WILL ANY COPYRIGHT HOLDER, OR ANY OTHER PARTY WHO MAY MODIFY AND/OR REDISTRIBUTE THE PROGRAM AS PERMITTED ABOVE, BE LIABLE TO YOU FOR DAMAGES, INCLUDING ANY GENERAL, SPECIAL, INCIDENTAL OR CONSEQUENTIAL DAMAGES ARISING OUT OF THE USE OR INABILITY TO USE THE PROGRAM (INCLUDING BUT NOT LIMITED TO LOSS OF DATA OR DATA BEING RENDERED INACCURATE OR LOSSES SUSTAINED BY YOU OR THIRD PARTIES OR A FAILURE OF THE PROGRAM TO OPERATE WITH ANY OTHER PROGRAMS), EVEN IF SUCH HOLDER OR OTHER PARTY HAS BEEN ADVISED OF THE POSSIBILITY OF SUCH DAMAGES.

END OF TERMS AND CONDITIONS

How to Apply These Terms to Your New Programs

If you develop a new program, and you want it to be of the greatest possible use to the public, the best way to achieve this is to make it free software which everyone can redistribute and change under these terms.

To do so, attach the following notices to the program. It is safest to attach them to the start of each source file to most effectively convey the exclusion of warranty; and each file should have at least the "copyright" line and a pointer to where the full notice is found.

<one line to give the program's name and a brief idea of what it does.>

Copyright © <year> <name of author>

This program is free software; you can redistribute it and/or modify it under the terms of the GNU General Public License as published by the Free Software Foundation; either version 2 of the License, or (at your option) any later version.

This program is distributed in the hope that it will be useful, but WITHOUT ANY WARRANTY; without even the implied warranty of MERCHANTABILITY or FITNESS FOR A PARTICULAR PURPOSE. See the GNU General Public License for more details.

Open Source software

You should have received a copy of the GNU General Public License along with this program; if not, write to the Free Software Foundation, Inc., 51 Franklin Street, Fifth Floor, Boston, MA 02110-1301 USA.

Also add information on how to contact you by electronic and paper mail.

If the program is interactive, make it output a short notice like this when it starts in an interactive mode:

```
Gnomovision version 69, Copyright © year name of author
```

```
Gnomovision comes with ABSOLUTELY NO WARRANTY; for details type `show w'.
```

```
This is free software, and you are welcome to redistribute it under certain conditions; type `show c' for details.
```

The hypothetical commands `show w' and `show c' should show the appropriate parts of the General Public License. Of course, the commands you use may be called something other than `show w' and `show c'; they could even be mouse-clicks or menu items--whatever suits your program.

You should also get your employer (if you work as a programmer) or your school, if any, to sign a "copyright disclaimer" for the program, if necessary. Here is a sample; alter the names:

```
Yoyodyne, Inc., hereby disclaims all copyright interest in the program `Gnomovision' (which makes passes at compilers) written by James Hacker.
```

```
<signature of Ty Coon>, 1 April 1989
```

```
Ty Coon, President of Vice
```

This General Public License does not permit incorporating your program into proprietary programs. If your program is a subroutine library, you may consider it more useful to permit linking proprietary applications with the library. If this is what you want to do, use the GNU Lesser General Public License instead of this License.

GNU LESSER GENERAL PUBLIC LICENSE

Version 2.1, February 1999

Copyright © 1991, 1999 Free Software Foundation, Inc. 51 Franklin Street, Fifth Floor, Boston, MA 02110-1301 USA

Everyone is permitted to copy and distribute verbatim copies of this license document, but changing it is not allowed.

[This is the first released version of the Lesser GPL. It also counts as the successor of the GNU Library Public License, version 2, hence the version number 2.1.]

Preamble

The licenses for most software are designed to take away your freedom to share and change it. By contrast, the GNU General Public Licenses are intended to guarantee your freedom to share and change free software--to make sure the software is free for all its users.

This license, the Lesser General Public License, applies to some specially designated software packages--typically libraries--of the Free Software Foundation and other authors who decide to use it. You can use it too, but we suggest you first think carefully about whether this license or the ordinary General Public License is the better strategy to use in any particular case, based on the explanations below.

When we speak of free software, we are referring to freedom of use, not price. Our General Public Licenses are designed to make sure that you have the freedom to distribute copies of free software (and charge for this service if you wish); that you receive source code or can get it if you want it; that you can change the software and use pieces of it in new free programs; and that you are informed that you can do these things.

To protect your rights, we need to make restrictions that forbid distributors to deny you these rights or to ask you to surrender these rights. These restrictions translate to certain responsibilities for you if you distribute copies of the library or if you modify it.

For example, if you distribute copies of the library, whether gratis or for a fee, you must give the recipients all the rights that we gave you. You must make sure that they, too, receive or can get the source code. If you link other code with the library, you must provide complete object files to the recipients, so that they can relink them with the library after making changes to the library and recompiling it. And you must show them these terms so they know their rights.

We protect your rights with a two-step method: (1) we copyright the library, and (2) we offer you this license, which gives you legal permission to copy, distribute and/or modify the library.

To protect each distributor, we want to make it very clear that there is no warranty for the free library. Also, if the library is modified by someone else and passed on, the recipients should know that what they have is not the original version, so that the original author's reputation will not be affected by problems that might be introduced by others.

Finally, software patents pose a constant threat to the existence of any free program. We wish to make sure that a company cannot effectively restrict the users of a free program by obtaining a restrictive license from a patent holder. Therefore, we insist that any patent license obtained for a version of the library must be consistent with the full freedom of use specified in this license.

Most GNU software, including some libraries, is covered by the ordinary GNU General Public License. This license, the GNU Lesser General Public License, applies to certain designated libraries, and is quite different from the ordinary General Public License. We use this license for certain libraries in order to permit linking those libraries into non-free programs.

When a program is linked with a library, whether statically or using a shared library, the combination of the two is legally speaking a combined work, a derivative of the original library. The ordinary General Public License therefore permits such linking only if the entire combination fits its criteria of freedom. The Lesser General Public License permits more lax criteria for linking other code with the library.

We call this license the "Lesser" General Public License because it does Less to protect the user's freedom than the ordinary General Public License. It also provides other free software developers Less of an advantage over competing non-free programs. These disadvantages are the reason we use the ordinary General Public License for many libraries. However, the Lesser license provides advantages in certain special circumstances.

For example, on rare occasions, there may be a special need to encourage the widest possible use of a certain library, so that it becomes a de-facto standard. To achieve this, non-free programs must be allowed to use the library. A more frequent case is that a free library does the same job as widely used non-free libraries. In this case, there is little to gain by limiting the free library to free software only, so we use the Lesser General Public License.

In other cases, permission to use a particular library in non-free programs enables a greater number of people to use a large body of free software. For example, permission to use the GNU C Library in non-free programs enables many more people to use the whole GNU operating system, as well as its variant, the GNU/Linux operating system.

Although the Lesser General Public License is Less protective of the users' freedom, it does ensure that the user of a program that is linked with the Library has the freedom and the wherewithal to run that program using a modified version of the Library.

The precise terms and conditions for copying, distribution and modification follow. Pay close attention to the difference between a "work based on the library" and a "work that uses the library". The former contains code derived from the library, whereas the latter must be combined with the library in order to run.

TERMS AND CONDITIONS FOR COPYING, DISTRIBUTION AND MODIFICATION

0. This License Agreement applies to any software library or other program which contains a notice placed by the copyright holder or other authorized party saying it may be distributed under the terms of this Lesser General Public License (also called "this License"). Each licensee is addressed as "you".

A "library" means a collection of software functions and/or data prepared so as to be conveniently linked with application programs (which use some of those functions and data) to form executables.

The "Library", below, refers to any such software library or work which has been distributed under these terms. A "work based on the Library" means either the Library or any derivative work under copyright law: that is to say, a work containing the Library or a portion of it, either verbatim or with modifications and/or translated straightforwardly into another language. (Hereinafter, translation is included without limitation in the term "modification".)

"Source code" for a work means the preferred form of the work for making modifications to it. For a library, complete source code means all the source code for all modules it contains, plus any associated interface definition files, plus the scripts used to control compilation and installation of the library.

Activities other than copying, distribution and modification are not covered by this License; they are outside its scope. The act of running a program using the Library is not restricted, and output from such a program is covered only if its contents constitute a work based on the Library (independent of the use of the Library in a tool for writing it). Whether that is true depends on what the Library does and what the program that uses the Library does.

1. You may copy and distribute verbatim copies of the Library's complete source code as you receive it, in any medium, provided that you conspicuously and appropriately publish on each copy an appropriate copyright notice and disclaimer of warranty; keep intact all the notices that refer to this License and to the absence of any warranty; and distribute a copy of this License along with the Library.

You may charge a fee for the physical act of transferring a copy, and you may at your option offer warranty protection in exchange for a fee.

2. You may modify your copy or copies of the Library or any portion of it, thus forming a work based on the Library, and copy and distribute such modifications or work under the terms of Section 1 above, provided that you also meet all of these conditions:

- a) The modified work must itself be a software library.
- b) You must cause the files modified to carry prominent notices stating that you changed the files and the date of any change.
- c) You must cause the whole of the work to be licensed at no charge to all third parties under the terms of this License.
- d) If a facility in the modified Library refers to a function or a table of data to be supplied by an application program that uses the facility, other than as an argument passed when the facility is invoked, then you must make a good faith effort to ensure that, in the event an application does not supply such function or table, the facility still operates, and performs whatever part of its purpose remains meaningful.

(For example, a function in a library to compute square roots has a purpose that is entirely well-defined independent of the application. Therefore, Subsection 2d requires that any application-supplied function or table used by this function must be optional: if the application does not supply it, the square root function must still compute square roots.)

Open Source software

These requirements apply to the modified work as a whole. If identifiable sections of that work are not derived from the Library, and can be reasonably considered independent and separate works in themselves, then this License, and its terms, do not apply to those sections when you distribute them as separate works. But when you distribute the same sections as part of a whole which is a work based on the Library, the distribution of the whole must be on the terms of this License, whose permissions for other licensees extend to the entire whole, and thus to each and every part regardless of who wrote it.

Thus, it is not the intent of this section to claim rights or contest your rights to work written entirely by you; rather, the intent is to exercise the right to control the distribution of derivative or collective works based on the Library.

In addition, mere aggregation of another work not based on the Library with the Library (or with a work based on the Library) on a volume of a storage or distribution medium does not bring the other work under the scope of this License.

3. You may opt to apply the terms of the ordinary GNU General Public License instead of this License to a given copy of the Library. To do this, you must alter all the notices that refer to this License, so that they refer to the ordinary GNU General Public License, version 2, instead of to this License. (If a newer version than version 2 of the ordinary GNU General Public License has appeared, then you can specify that version instead if you wish.) Do not make any other change in these notices.

Once this change is made in a given copy, it is irreversible for that copy, so the ordinary GNU General Public License applies to all subsequent copies and derivative works made from that copy.

This option is useful when you wish to copy part of the code of the Library into a program that is not a library.

4. You may copy and distribute the Library (or a portion or derivative of it, under Section 2) in object code or executable form under the terms of Sections 1 and 2 above provided that you accompany it with the complete corresponding machine-readable source code, which must be distributed under the terms of Sections 1 and 2 above on a medium customarily used for software interchange.

If distribution of object code is made by offering access to copy from a designated place, then offering equivalent access to copy the source code from the same place satisfies the requirement to distribute the source code, even though third parties are not compelled to copy the source along with the object code.

5. A program that contains no derivative of any portion of the Library, but is designed to work with the Library by being compiled or linked with it, is called a "work that uses the Library". Such a work, in isolation, is not a derivative work of the Library, and therefore falls outside the scope of this License.

However, linking a "work that uses the Library" with the Library creates an executable that is a derivative of the Library (because it contains portions of the Library), rather than a "work that uses the library". The executable is therefore covered by this License. Section 6 states terms for distribution of such executables.

When a "work that uses the Library" uses material from a header file that is part of the Library, the object code for the work may be a derivative work of the Library even though the source code is not. Whether this is true is especially significant if the work can be linked without the Library, or if the work is itself a library. The threshold for this to be true is not precisely defined by law.

If such an object file uses only numerical parameters, data structure layouts and accessors, and small macros and small inline functions (ten lines or less in length), then the use of the object file is unrestricted, regardless of whether it is legally a derivative work. (Executables containing this object code plus portions of the Library will still fall under Section 6.)

Otherwise, if the work is a derivative of the Library, you may distribute the object code for the work under the terms of Section 6. Any executables containing that work also fall under Section 6, whether or not they are linked directly with the Library itself.

6. As an exception to the Sections above, you may also combine or link a "work that uses the Library" with the Library to produce a work containing portions of the Library, and distribute that work under terms of your choice, provided that the terms permit modification of the work for the customer's own use and reverse engineering for debugging such modifications.

You must give prominent notice with each copy of the work that the Library is used in it and that the Library and its use are covered by this License. You must supply a copy of this License. If the work during execution displays copyright notices, you must include the copyright notice for the Library among them, as well as a reference directing the user to the copy of this License. Also, you must do one of these things:

a) Accompany the work with the complete corresponding machine-readable source code for the Library including whatever changes were used in the work (which must be distributed under Sections 1 and 2 above); and, if the work is an executable linked with the Library, with the complete machine-readable "work that uses the Library", as object code and/or source code, so that the user can modify the Library and then relink to produce a modified executable containing the modified Library. (It is understood that the user who changes the contents of definitions files in the Library will not necessarily be able to recompile the application to use the modified definitions.)

b) Use a suitable shared library mechanism for linking with the Library. A suitable mechanism is one that (1) uses at run time a copy of the library already present on the user's computer system, rather than copying library functions into the executable, and (2) will operate properly with a modified version of the library, if the user installs one, as long as the modified version is interface-compatible with the version that the work was made with.

c) Accompany the work with a written offer, valid for at least three years, to give the same user the materials specified in Subsection 6a, above, for a charge no more than the cost of performing this distribution.

d) If distribution of the work is made by offering access to copy from a designated place, offer equivalent access to copy the above specified materials from the same place.

e) Verify that the user has already received a copy of these materials or that you have already sent this user a copy.

For an executable, the required form of the "work that uses the Library" must include any data and utility programs needed for reproducing the executable from it. However, as a special exception, the materials to be distributed need not include anything that is normally distributed (in either source or binary form) with the major components (compiler, kernel, and so on) of the operating system on which the executable runs, unless that component itself accompanies the executable.

It may happen that this requirement contradicts the license restrictions of other proprietary libraries that do not normally accompany the operating system. Such a contradiction means you cannot use both them and the Library together in an executable that you distribute.

7. You may place library facilities that are a work based on the Library side-by-side in a single library together with other library facilities not covered by this License, and distribute such a combined library, provided that the separate distribution of the work based on the Library and of the other library facilities is otherwise permitted, and provided that you do these two things:

a) Accompany the combined library with a copy of the same work based on the Library, uncombined with any other library facilities. This must be distributed under the terms of the Sections above.

b) Give prominent notice with the combined library of the fact that part of it is a work based on the Library, and explaining where to find the accompanying uncombined form of the same work.

8. You may not copy, modify, sublicense, link with, or distribute the Library except as expressly provided under this License. Any attempt otherwise to copy, modify, sublicense, link with, or distribute the Library is void, and will automatically terminate your rights under this License. However, parties who have received copies, or rights, from you under this License will not have their licenses terminated so long as such parties remain in full compliance.

9. You are not required to accept this License, since you have not signed it. However, nothing else grants you permission to modify or distribute the Library or its derivative works. These actions are prohibited by law if you do not accept this License. Therefore, by modifying or distributing the Library (or any work based on the Library), you indicate your acceptance of this License to do so, and all its terms and conditions for copying, distributing or modifying the Library or works based on it.

10. Each time you redistribute the Library (or any work based on the Library), the recipient automatically receives a license from the original licensor to copy, distribute, link with or modify the Library subject to these terms and conditions. You may not impose any further restrictions on the recipients' exercise of the rights granted herein. You are not responsible for enforcing compliance by third parties with this License.

11. If, as a consequence of a court judgment or allegation of patent infringement or for any other reason (not limited to patent issues), conditions are imposed on you (whether by court order, agreement or otherwise) that contradict the conditions of this License, they do not excuse you from the conditions of this License. If you cannot distribute so as to satisfy simultaneously your obligations under this License and any other pertinent obligations, then as a consequence you may not distribute the Library at all. For example, if a patent license would not permit royalty-free redistribution of the Library by all those who receive copies directly or indirectly through you, then the only way you could satisfy both it and this License would be to refrain entirely from distribution of the Library.

If any portion of this section is held invalid or unenforceable under any particular circumstance, the balance of the section is intended to apply, and the section as a whole is intended to apply in other circumstances.

It is not the purpose of this section to induce you to infringe any patents or other property right claims or to contest validity of any such claims; this section has the sole purpose of protecting the integrity of the free software distribution system which is implemented by public license practices. Many people have made generous contributions to the wide range of software distributed through that system in reliance on consistent application of that system; it is up to the author/donor to decide if he or she is willing to distribute software through any other system and a licensee cannot impose that choice.

This section is intended to make thoroughly clear what is believed to be a consequence of the rest of this License.

12. If the distribution and/or use of the Library is restricted in certain countries either by patents or by copyrighted interfaces, the original copyright holder who places the Library under this License may add an explicit geographical distribution limitation excluding those countries, so that distribution is permitted only in or among countries not thus excluded. In such case, this License incorporates the limitation as if written in the body of this License.

13. The Free Software Foundation may publish revised and/or new versions of the Lesser General Public License from time to time. Such new versions will be similar in spirit to the present version, but may differ in detail to address new problems or concerns.

Each version is given a distinguishing version number. If the Library specifies a version number of this License which applies to it and "any later version", you have the option of following the terms and conditions either of that version or of any later version published by the Free Software Foundation. If the Library does not specify a license version number, you may choose any version ever published by the Free Software Foundation.

14. If you wish to incorporate parts of the Library into other free programs whose distribution conditions are incompatible with these, write to the author to ask for permission. For software which is copyrighted by the Free Software Foundation, write to the Free Software Foundation; we sometimes make exceptions for this. Our decision will be guided by the two goals of preserving the free status of all derivatives of our free software and of promoting the sharing and reuse of software generally.

Open Source software

NO WARRANTY

15. BECAUSE THE LIBRARY IS LICENSED FREE OF CHARGE, THERE IS NO WARRANTY FOR THE LIBRARY, TO THE EXTENT PERMITTED BY APPLICABLE LAW. EXCEPT WHEN OTHERWISE STATED IN WRITING THE COPYRIGHT HOLDERS AND/OR OTHER PARTIES PROVIDE THE LIBRARY "AS IS" WITHOUT WARRANTY OF ANY KIND, EITHER EXPRESSED OR IMPLIED, INCLUDING, BUT NOT LIMITED TO, THE IMPLIED WARRANTIES OF MERCHANTABILITY AND FITNESS FOR A PARTICULAR PURPOSE. THE ENTIRE RISK AS TO THE QUALITY AND PERFORMANCE OF THE LIBRARY IS WITH YOU. SHOULD THE LIBRARY PROVE DEFECTIVE, YOU ASSUME THE COST OF ALL NECESSARY SERVICING, REPAIR OR CORRECTION.

16. IN NO EVENT UNLESS REQUIRED BY APPLICABLE LAW OR AGREED TO IN WRITING WILL ANY COPYRIGHT HOLDER, OR ANY OTHER PARTY WHO MAY MODIFY AND/OR REDISTRIBUTE THE LIBRARY AS PERMITTED ABOVE, BE LIABLE TO YOU FOR DAMAGES, INCLUDING ANY GENERAL, SPECIAL, INCIDENTAL OR CONSEQUENTIAL DAMAGES ARISING OUT OF THE USE OR INABILITY TO USE THE LIBRARY (INCLUDING BUT NOT LIMITED TO LOSS OF DATA OR DATA BEING RENDERED INACCURATE OR LOSSES SUSTAINED BY YOU OR THIRD PARTIES OR A FAILURE OF THE LIBRARY TO OPERATE WITH ANY OTHER SOFTWARE), EVEN IF SUCH HOLDER OR OTHER PARTY HAS BEEN ADVISED OF THE POSSIBILITY OF SUCH DAMAGES.

END OF TERMS AND CONDITIONS

How to Apply These Terms to Your New Libraries

If you develop a new library, and you want it to be of the greatest possible use to the public, we recommend making it free software that everyone can redistribute and change. You can do so by permitting redistribution under these terms (or, alternatively, under the terms of the ordinary General Public License).

To apply these terms, attach the following notices to the library. It is safest to attach them to the start of each source file to most effectively convey the exclusion of warranty; and each file should have at least the "copyright" line and a pointer to where the full notice is found.

<one line to give the library's name and a brief idea of what it does.>

Copyright© <year> <name of author>

This library is free software; you can redistribute it and/or modify it under the terms of the GNU Lesser General Public License as published by the Free Software Foundation; either version 2.1 of the License, or (at your option) any later version.

This library is distributed in the hope that it will be useful, but WITHOUT ANY WARRANTY; without even the implied warranty of MERCHANTABILITY or FITNESS FOR A PARTICULAR PURPOSE. See the GNU Lesser General Public License for more details.

You should have received a copy of the GNU Lesser General Public License along with this library; if not, write to the Free Software Foundation, Inc., 51 Franklin Street, Fifth Floor, Boston, MA 02110-1301 USA

Also add information on how to contact you by electronic and paper mail.

You should also get your employer (if you work as a programmer) or your school, if any, to sign a "copyright disclaimer" for the library, if necessary. Here is a sample; alter the names:

Yoyodyne, Inc., hereby disclaims all copyright interest in the library 'Frob' (a library for tweaking knobs) written by James Random Hacker.

<signature of Ty Coon>, 1 April 1990

Ty Coon, President of Vice

That's all there is to it!

Index

A

- Access code (PABX) 69
- Accessories 86
- Activating
 - alarm clock 61
 - answering machine 41
 - answering machine (remote operation)..... 43
 - muting ring tone 65
 - two-way recording 43
- Activating/deactivating
 - answering machine 42
 - function 26
- Activating/deactivating microphone (handset)..... 31
- Activating/deactivating silent alert 36
- Activating/deactivating the crescendo tone reminder signal 59
- ring tone 36
- Activating/deactivating the key tone ... 17
- Activating/deactivating the key vibration 17
- Advisory tones 36
- Alarm 61
- Alarm clock
 - activating/deactivating 61
- Alphanumeric keypad 17
- Anniversary, see Birthday
- Announcement (answering machine) ... 41
- Anonymous call off 37
- Answering machine 41
 - activating/deactivating 41
 - deleting all messages 22
 - deleting messages 42
 - playing back messages 21, 42
 - recording 43
 - recording a personal announcement/ advisory message 41
 - remote operation 43
 - skip-back function 43
 - time control 41
- Answering machine list 20
- Applications
 - adding to config. page 18
 - deleting from config. Page 18
 - selectable for config. page 19
- Applications menu 23
- Appointment
 - deleting list of missed 22
 - deleting missed 60
 - displaying missed 60
 - setting 59
- Area code
 - setting own area code 34
- Area code - prefix 13
- Arrow in option slider 25
- Auto answer 35, 76

B

- Baby phone call 59
- Back function 26, 27
- Backlight timeout, display 34
- Backlight, display 34
- Base
 - changing 46
 - changing settings 34
 - changing system PIN 38
 - connecting to PABX 69
 - connecting to power/telephone network 6
 - restoring default settings 38
 - setting 9
 - setting up 5
 - variants 1 and 2 2
 - wall mounting 7
- Battery
 - charging 9
 - charging status 72
 - inserting 8
- Battery charging status 72
- Battery warning 36
- Best base 46
- Birthday 53
 - deleting list of missed 22
 - deleting missed 60
 - displaying missed 60
 - missed 60
 - saving to Contacts 53

Index

- Bluetooth
 - accepting call 52
 - activating 50
 - calling with a headset 52
 - changing device name 51
 - ending a search 51
 - list of known devices 51
 - registering devices 50
 - starting a search 50
 - transferring Contacts (vCard) 56
 - transferring vCards 56
- C**
- Calendar 59
- Call
 - accepting 30
 - accepting (Bluetooth) 52
 - answering automatically 35
 - diverting (ans. mach.) 43
 - external 29
 - internal 47
 - internal transfer (connecting) 48
 - participant listening in 49
 - picking up from answering machine .. 43
 - protection from undesired 37
 - recording 43
 - redirecting (ans. mach.) 43
 - transferring (connecting) 48
- Call list 29, 58
 - deleting an entry 21
 - deleting entire lists 22
 - deleting the entire list 22
 - dialling with 29
- Call screening during recording
 - (ans. mach.) 42
- Call Waiting 48
- Caller picture 54, 63
- Calling
 - external 29
 - internal 47
- Calling Line Identification 30
- Care of the device 83
- Changing device name (Bluetooth) 51
- Changing display page 17, 23
- Changing page 17, 23
- Changing settings
 - user interface elements 26
- Changing telephone settings 34
- Changing the character set 28
- Changing the keypad layout 28
- Changing the settings 34
- Character set
 - Cyrillic 28
 - Greek 28
- Charger cradle (handset)
 - connecting 7
 - setting up 5
- Charging contacts 1
- Charging time of handset 84
- Check
 - data security of DECT connection 32
- Checking service information 22, 82
- CLIP 31
- CLIP picture see caller picture
- Cloud synchronisation 15, 68
- Configurable page (idle display) 18
 - configuring 18
 - deleting application/function 18
 - inserting application/function 18
 - selectable applications/functions 19
- Connecting the phone cable 6
- Connecting the power cable 6
- Connecting to base 46
- Consultation call
 - ending 33
 - external 33
 - internal 48
- Contact with liquid 84
- Contacts 53
 - copying number from text 56
 - creating entry 53
 - deleting all entries 22
 - managing entries 53
 - opening 53
 - order of entries 54
 - saving birthdays 53
 - saving entry 53
 - sending entry/list to handset 55
 - sending to handset 55
 - sending vCards with Bluetooth 56
 - transferring vCards with Bluetooth ... 56
 - using to enter numbers 57
- Correcting incorrect entries 28
- Customer service & product warranty ... 78

D

- Deactivating
 - alarm clock 61
 - answering machine 41
 - baby phone call 63
 - muting ring tone 65
 - two-way recording 43
- Deleting
 - announcement for answering machine 41
 - lists 22
 - message (answering machine) 42
 - QuickDial 57
- Deregistering (handset) 47
- Destination number (baby phone call) .. 62
- Dial page (idle display) 17
- Dialling
 - using the call list 29
 - using the redial list 29
 - with Contacts 30
- Dialling page (idle display) 29
- Dialling pause 69
- Display
 - activating/deactivating new messages 35
 - backlight 34
 - contacts memory 54
 - in idle status 17
 - network mailbox message 20, 45
 - number (CLI/CLIP) 30
 - screensaver 34
 - setting 34
 - timeout for backlight 34
- Display icons 71
- Display lock
 - activating/deactivating 24
 - automatic 24
- Displaying
 - missed appointments/birthdays 60
- Disposal 83
- Diverting a call
 - to answering machine 43
- Draft message list (SMS) 64

E

- Earpiece mode 31
- Earpiece volume 31
- ECO DECT 39
- Eco mode+ (switching off wireless module) 39
- End call/end key 1, 23, 29
- End key, see End call/end key
- Entering diacritical characters 28
- Entering special characters 28
- Entering text 27
- Entering umlauts 28
- Entry in Contacts 53
- Environment 82
- Exclusion of liability 82
- External call
 - diverting to answering machine 43
 - internal transfer (connecting) 48
- External calls
 - time control for ring tone 37
- External line code (PABX) 69

F

- Firmware
 - checking version 82
 - updating the handset (Gigaset QuickSync) 68
- Function
 - activating/deactivating 26
 - selecting 25

G

- Getting started 5
- Gigaset QuickSync 68
- GNU General Public License (GPL)
 - English 89
- GNU Lesser General Public License (LGPL), English 89
- GPL 89
- Green dot 22, 29, 30
- Group call 47

Index

H

| | |
|---|--------|
| Handset | |
| activating/deactivating | 24 |
| advisory tones | 36 |
| changing settings | 34 |
| changing to best reception | 46 |
| changing to different base | 46 |
| checking service information | 22 |
| connecting charger cradle | 7 |
| deregistering | 47 |
| display backlight | 34 |
| display language | 34 |
| earpiece volume | 31 |
| idle display | 17 |
| idle status | 24 |
| in idle status | 14, 17 |
| muting | 31 |
| paging | 47 |
| registering | 46 |
| registering another Gigaset | 46 |
| registering to different base | 46 |
| reset | 38 |
| restoring to default settings | 38 |
| screensaver | 34 |
| searching for | 47 |
| setting | 9, 34 |
| setting up | 7 |
| speaker volume | 31 |
| transferring a call | 48 |
| using baby phone call | 59 |
| using multiple | 46 |
| Handset + base | 46 |
| Handset operating time | |
| in baby phone call mode | 62 |
| Handsfree volume | 31 |
| Headset (Bluetooth) | 52 |
| accepting a call | 52 |
| Hearing aids | 4 |
| Help | 80 |

I

| | |
|--|-----------|
| Icons | |
| displaying new messages | 21 |
| options bar | 71 |
| status bar | 72 |
| Idle display | |
| changing page | 17, 23 |
| configurable page | 18 |
| dial page | 17 |
| handset | 17 |
| messages page | 20 |
| Idle status | |
| handset | 14, 17 |
| returning to | 24 |
| Images used for menu operation | 16 |
| Inbox (SMS) | 20, 65 |
| Incorrect entry correction | 28 |
| Installation wizard | 9 |
| Internal | |
| listening in | 49 |
| making calls | 47 |
| Internal call | 47 |
| Internal consultation call | 48 |
| K | |
| Key lock | |
| automatic | 24 |
| Keypad | |
| alphanumeric | 17 |
| with R / P | 17 |
| Keypad lock | |
| activating/deactivating | 24 |
| Keypad/display lock on/off | 1, 24 |
| Keys | |
| end call/end key | 1, 29 |
| handset | 1 |
| menu key | 1 |
| paging key (base) | 2 |
| talk key | 1, 29, 30 |

- L**
- Language + region 16, 34
 - License
 - GPL 89
 - GPL 89
 - Liquid 84
 - List
 - accepted calls 58
 - answering machine 20
 - call lists 58
 - cleaning up. 22, 42, 54, 60, 65
 - deleting 22
 - known devices (Bluetooth). 51
 - missed calls. 58
 - network mailbox. 20
 - opening via message pop-up 21
 - outgoing calls 58
 - scrolling in 25
 - selecting entry. 25
 - SMS draft message list. 64
 - SMS incoming list 20, 65
 - List entry 21
 - Listening in on an external call 49
 - Locating
 - handset 47
 - Lock
 - activating/deactivating 24
 - automatic 24
 - Lower/upper case 28
- M**
- Main menu settings 73
 - Making calls
 - accepting a call 30
 - external 29
 - internal 47
 - Media pool 63
 - Medical equipment 4
 - Melody
 - ring tone for internal/external calls . . . 36
 - Memory space in Contacts 54
 - Menu
 - applications 23
 - changing page. 17, 23
 - opening. 23
 - returning to idle status 23
 - Menu key. 1, 23
 - Menu operation, images used 16
 - Menu settings 73
 - Message display 35
 - Message LED 1, 21
 - activating/deactivating. 35
 - Message length (ans. mach.) 42
 - Message list
 - deleting 22
 - opening. 20
 - Message page (idle display) 20
 - Message pop-up 21
 - closing 21
 - Messages
 - delete (ans. mach.) 42
 - deleting. 21
 - playing back (ans. mach.) 42
 - Microphone sensitivity 31
 - Mini USB connection socket. 1
 - Missed birthdays/appointments. 60
 - Missed calls. 58
 - Mounting the base on the wall 7
 - Music on hold. 37
 - Muting
 - first ring. 65
 - Muting the handset 31
- N**
- Navigation area 1, 17, 23
 - Network mailbox. 45
 - Network services
 - during an external call. 33
 - provider-specific 32
 - Number
 - as destination for baby phone call 62
 - copying to Contacts 56
 - displaying caller's number (CLIP) 30
 - entering with Contacts 57
 - preferred 57
 - saving in Contacts 53
 - Numbers
 - entering. 27

Index

O

| | |
|--|----|
| Opening the submenu..... | 27 |
| Operating remotely | 43 |
| Operating time of handset | 84 |
| Option slider | |
| showing/hiding..... | 26 |
| Options | 25 |
| Options bar..... | 25 |
| icons..... | 71 |
| Order in Contacts | 54 |
| Other Gigaset handsets | |
| registering | 46 |
| Outside line code | 69 |
| Overview | |
| setting options | 73 |
| Own page (idle display) | |
| deleting application/function | 18 |
| inserting application/function | 18 |
| selectable applications/functions..... | 19 |

P

| | |
|------------------------------------|-------|
| PABX | |
| connecting base | 69 |
| pauses | 69 |
| saving access code..... | 69 |
| SMS..... | 66 |
| Package contents | 5 |
| Paging | 2, 47 |
| Paging key..... | 2 |
| Parameter | 26 |
| Pause | |
| after access code..... | 69 |
| after line seizure | 69 |
| after recall key | 69 |
| PC Interface | 68 |
| Phone | |
| operating | 24 |
| restoring to factory settings..... | 38 |
| setting | 34 |
| Phone number display, notes | 31 |
| Picture | |
| caller..... | 63 |
| Pin connections | 85 |
| PIN, changing..... | 38 |
| Playing back | |
| announcement (answering machine) . | 41 |
| message (answering machine) | 42 |

| | |
|--------------------------------------|--------|
| Power adapter | 4 |
| Power consumption | 85 |
| Preferred number | 53, 57 |
| Prefix for area code..... | 13 |
| Protection from undesired calls..... | 37 |
| Proximity sensor | 1, 24 |

Q

| | |
|--------------------------------|----|
| Questions and answers | 80 |
| Quick access | |
| to functions/applications..... | 18 |
| QuickDial | |
| configuring..... | 57 |
| QuickDial shortcut | 57 |
| QuickSync | 68 |

R

| | |
|--------------------------------------|----|
| Range..... | 5 |
| Recall | 69 |
| Recall key..... | 69 |
| Reception booster, see Repeater | |
| Recording | |
| announcements (answering | |
| machine)..... | 41 |
| two-way recording..... | 43 |
| Recording (ans. mach.)..... | 43 |
| Recording quality (ans. mach.)..... | 42 |
| Redial list | |
| dialling with | 29 |
| Redirecting (ans. mach.) | 43 |
| Reducing radiation | 39 |
| Reducing transmission power..... | 39 |
| Registered handsets..... | 47 |
| Registering (handset)..... | 46 |
| Registering device (Bluetooth) | 50 |
| Registration mode | 2 |
| Reminder signal..... | 59 |
| activating/deactivating crescendo | |
| tone..... | 59 |
| setting volume | 59 |
| Repeater | 37 |
| Reset | |
| handset | 38 |
| Ring delay | |
| answering machine | 42 |
| automatic | 76 |

- Ring tone
 - activating/deactivating crescendo
 - tone 36
 - changing 35
 - deactivating for anonymous calls 37
 - melody for internal/external calls 36
 - muting 65
 - muting first ring 65
 - setting volume 36
 - time control for external calls 37
- S**
- Safety precautions 4
- Screensaver 34, 63
- Scrolling
 - horizontally 25
 - in lists 25
 - vertical 25
- Searching
 - Bluetooth devices 50
 - in Contacts 55
- Secure connection to base 32
- Security check
 - handset/base connection 32
- Selecting entry from Contacts 55
- Selection fields 27
- Sending
 - complete Contacts to handset 55
 - Contacts entry to handset 55
 - SMS 64
 - vCards with Bluetooth 56
- Service function
 - number code 70
 - setting 70
 - starting 70
- Setting options
 - answering machine 41
 - overview 73
- Setting the area code 9
- Setting the country 9
- Setting the date 9
- Setting the display language 9, 34
- Setting the keypad 17
- Setting the time 9
- Setting up, handset 7
- Settings menu 73
- Settings options
 - telephone 34
- Signal strength 72
- Signal tone, see Advisory tones
- Skip-back function (answering
 - machine) 43
- SMS 64
 - active send 66
 - buffering 64
 - deleting 65
 - deleting the inbox 22
 - draft message list 64
 - incoming list 20, 65
 - reading 65
 - receiving 65
 - self help with error messages 67
 - sending 64
 - special features when writing 64
 - to PABXs 66
 - troubleshooting 67
 - writing 64
 - writing/sending 64
- SMS centre
 - changing number 66
 - setting 66
- SMS inbox 20
- Snooze mode (alarm) 61
- Sound, see Ring tone
- Speaker 31
- Speaker profile 35
- Special functions 69
- Specifications 84
- Speed dial 19
- Speed dial, see QuickDial
- Status bar 1, 22
 - icons 72
- Status page 22
 - opening/closing 22
- Switch 26
- Switching off wireless module 39
- Switching on/off
 - answering machine 42
 - function 26
- Synchronising Contacts 15, 68
- Synchronising Google contacts 15, 68
- System PIN
 - changing 38
 - resetting 38

Index

T

- Talk key 1, 29, 30
- Telephone jack, pin connections. 85
- Text message, see SMS
- Time control
 - ring tone for external calls 37
- Time control (ans. mach.) 41
- Time, setting 9
- Timeout for display backlight 34
- Tone dialling 69
- Tones + signals 35, 37
- Touchscreen 1
 - operating 25
- Transferring (internal)
 - external call 48
- Troubleshooting
 - general 80
 - SMS 67

U

- Unknown 31
- Unknown caller 31
- Unprotected connection to base 32
- Upper/lower case 28
- USB connection socket 1
- User interface elements 26
- Using the redial list 29

V

- vCard
 - receiving with Bluetooth 56
 - sending with Bluetooth 56
- Vertical scrolling 25
- Vibration, key 17
- Viewing network mailbox message .. 20, 45
- VIP ring tone 53, 54
- Volume
 - handsfree/earpiece volume of
 - handset 31
 - reminder signal 59
 - ring tone 36

W

- Warning tone, see Advisory tones
- Writing (SMS) 64

Issued by

Gigaset Communications GmbH
Frankenstr. 2a, D-46395 Bocholt

© Gigaset Communications GmbH 2013

Subject to availability.

All rights reserved. Rights of modification reserved.

www.gigaset.com