

EN	Dear Customer, Gigaset Communications GmbH is the legal successor to Siemens Home and Office Communication Devices GmbH & Co. KG (SHC), which in turn continued the Gigaset business of Siemens AG. Any statements made by Siemens AG or SHC that are found in the user guides should therefore be understood as statements of Gigaset Communications GmbH. We hope you enjoy your Gigaset.	DA	Kære Kunde, Gigaset Communications GmbH er retlig efterfølger til Siemens Home and Office Communication Devices GmbH & Co. KG (SHC), som fra deres side videreførte Siemens AGs Gigaset-forretninger. Siemens AGs eller SHCs eventuelle forklaringer i betjeningsvejledningerne skal derfor forstås som Gigaset Communications GmbHs forklaringer. Vi håber, du får meget glæde af din Gigaset.
DE	Sehr geehrte Kundin, sehr geehrter Kunde, die Gigaset Communications GmbH ist Rechtsnachfolgerin der Siemens Home and Office Communication Devices GmbH & Co. KG (SHC), die ihrerseits das Gigaset-Geschäft der Siemens AG fortführte. Etwaige Erklärungen der Siemens AG oder der SHC in den Bedienungsanleitungen sind daher als Erklärungen der Gigaset Communications GmbH zu verstehen. Wir wünschen Ihnen viel Freude mit Ihrem Gigaset.	FI	Arvoisa asiakkaamme, Gigaset Communications GmbH on Siemens Home and Office Communication Devices GmbH & Co. KG (SHC)-yhtiöksen oikeudenomistaja, joka jatkoj puolestaan Siemens AG:n Gigaset-liiketoimintaa. Käyttöoppaissa mahdollisesti esiintyvät Siemens AG:n tai SHC:n selosteet on tämän vuoksi ymmärrettävä Gigaset Communications GmbH:n selosteina. Toivotamme Teille paljon iloa Gigaset-laitteestanne.
FR	Chère Cliente, Cher Client, la société Gigaset Communications GmbH succède en droit à Siemens Home and Office Communication Devices GmbH & Co. KG (SHC) qui poursuivait elle-même les activités Gigaset de Siemens AG. Donc les éventuelles explications de Siemens AG ou de SHC figurant dans les modes d'emploi doivent être comprises comme des explications de Gigaset Communications GmbH. Nous vous souhaitons beaucoup d'agrément avec votre Gigaset.	SV	Kära kund, Gigaset Communications GmbH övertar rättigheterna från Siemens Home and Office Communication Devices GmbH & Co. KG (SHC), som bedrev Gigaset-verksamheten efter Siemens AG. Alla förklaringar från Siemens AG eller SHC i användarhandboken gäller därför som förklaringar från Gigaset Communications GmbH. Vi önskar dig mycket nöje med din Gigaset.
IT	Gentile cliente, la Gigaset Communications GmbH è successore della Siemens Home and Office Communication Devices GmbH & Co. KG (SHC) che a sua volta ha proseguito l'attività della Siemens AG. Eventuali dichiarazioni della Siemens AG o della SHC nei manuali d'istruzione, vanno pertanto intese come dichiarazioni della Gigaset Communications GmbH. Le auguriamo tanta soddisfazione con il vostro Gigaset.	NO	Kjære kunde, Gigaset Communications GmbH er rettslig etterfølger etter Siemens Home and Office Communication Devices GmbH & Co. KG (SHC), som i sin tur videreførte Gigaset-geskjeften i Siemens AG. Eventuelle meddelelser fra Siemens AG eller SHC i bruksanvisningene er derfor å forstå som meddelelser fra Gigaset Communications GmbH. Vi håper du får stor glede av din Gigaset-enhet.
NL	Geachte klant, Gigaset Communications GmbH is de rechtsopvolger van Siemens Home and Office Communication Devices GmbH & Co. KG (SHC), de onderneming die de Gigaset-activiteiten van Siemens AG heeft overgenomen. Eventuele uitspraken of mededelingen van Siemens AG of SHC in de gebruiksaanwijzingen dienen daarom als mededelingen van Gigaset Communications GmbH te worden gezien. Wij wensen u veel plezier met uw Gigaset.	EL	Αγαπητή πελάτισσα, αγαπητέ πελάτη, η Gigaset Communications GmbH είναι η νομική διάδοχος της Siemens Home and Office Communication Devices GmbH & Co. KG (SHC), η οποία έχει αναλάβει την εμπορική δραστηριότητα Gigaset της Siemens AG. Οι δηλώσεις της Siemens AG ή της SHC στις οδηγίες χρήσης αποτελούν επομένως δηλώσεις της Gigaset Communications GmbH. Σας ευχόμαστε καλή διασκέδαση με τη συσκευή σας Gigaset.
ES	Estimado cliente, la Gigaset Communications GmbH es derechohabiente de la Siemens Home and Office Communication Devices GmbH & Co. KG (SHC) que por su parte continuó el negocio Gigaset de la Siemens AG. Las posibles declaraciones de la Siemens AG o de la SHC en las instrucciones de uso se deben entender por lo tanto como declaraciones de la Gigaset Communications GmbH. Le deseamos que disfrute con su Gigaset.	HR	Poštovani korisnici, Gigaset Communications GmbH pravni je sljednik tvrtke Siemens Home and Office Communication Devices GmbH & Co. KG (SHC), koji je nastavio Gigaset poslovanje tvrtke Siemens AG. Zato sve izjave tvrtke Siemens AG ili SHC koje se nalaze u uputama za upotrebu treba tumačiti kao izjave tvrtke Gigaset Communications GmbH. Nadamo se da sa zadovoljstvom koristite svoj Gigaset uređaj.
PT	SCaros clientes, Gigaset Communications GmbH é a sucessora legal da Siemens Home and Office Communication Devices GmbH & Co. KG (SHC), que, por sua vez, deu continuidade ao sector de negócios Gigaset, da Siemens AG. Quaisquer declarações por parte da Siemens AG ou da SHC encontradas nos manuais de utilização deverão, portanto, ser consideradas como declarações da Gigaset Communications GmbH. Desejamos que tenham bons momentos com o seu Gigaset.	SL	Spoštovani kupec! Podjetje Gigaset Communications GmbH je pravni naslednik podjetja Siemens Home and Office Communication Devices GmbH & Co. KG (SHC), ki nadaljuje dejavnost znamke Gigaset podjetja Siemens AG. Vse izjave podjetja Siemens AG ali SHC v priložnikih za uporabnike torej veljajo kot izjave podjetja Gigaset Communications GmbH. Želimo vam veliko učinkov ob uporabi naprave Gigaset.

- CS** Vážení zákazníci,
společnost Gigaset Communications GmbH je právním nástupcem společnosti Siemens Home and Office Communication Devices GmbH & Co. KG (SHC), která dále přejala segment produktů Gigaset společnosti Siemens AG. Jakékoli prohlášení společnosti Siemens AG nebo SHC, které naleznete v uživatelských příručkách, je třeba považovat za prohlášení společnosti Gigaset Communications GmbH. Doufáme, že jste s produkty Gigaset spokojeni.
- SK** Vážený zákazník,
Spoločnosť Gigaset Communications GmbH je právnym nástupcom spoločnosti Siemens Home and Office Communication Devices GmbH & Co. KG (SHC), ktorá zasa pokračovala v činnosti divízie Gigaset spoločnosti Siemens AG. Z tohto dôvodu je potrebné všetky vyhlásenia spoločnosti Siemens AG alebo SHC, ktoré sa nachádzajú v používateľských príručkách, chápať ako vyhlásenia spoločnosti Gigaset Communications GmbH. Veríme, že budete so zariadením Gigaset spokojní.
- RO** Stimatе client,
Gigaset Communications GmbH este succesorul legal al companiei Siemens Home and Office Communication Devices GmbH & Co. KG (SHC), care, la rândul său, a continuat activitatea companiei Gigaset a Siemens AG. Orice afirmații efectuate de Siemens AG sau SHC și incluse în ghidurile de utilizare vor fi, prin urmare, considerate a aparține Gigaset Communications GmbH.
Sperăm ca produsele Gigaset să fie la înălțimea dorințelor dvs.
- SR** Poštovani potrošaču,
Gigaset Communications GmbH je pravni naslednik kompanije Siemens Home and Office Communication Devices GmbH & Co. KG (SHC), kroz koju je nastavljeno poslovanje kompanije Gigaset kao dela Siemens AG. Stoga sve izjave od strane Siemens AG ili SHC koje se mogu naći u korisničkim uputstvima treba tumačiti kao izjave kompanije Gigaset Communications GmbH.
Nadamo se da ćete uživati u korišćenju svog Gigaset uređaja.
- BG** Уважаеми потребители,
Gigaset Communications GmbH е правоприемникът на Siemens Home and Office Communication Devices GmbH & Co. KG (SHC), която на свой ред продължи бизнеса на подразделението Siemens AG. По тази причина всякакви изложения, направени от Siemens AG или SHC, които се намират в ръководствата за потребителя, следва да се разбират като изложения на Gigaset Communications GmbH.
Надяваме се да ползвате с удоволствие вашия Gigaset.
- HU** Tisztelt Vásárló!
A Siemens Home and Communication Devices GmbH & Co. KG (SHC) törvényes jogutódja a Gigaset Communications GmbH, amely a Siemens AG Gigaset üzletágának utódja. Ebből következően a Siemens AG vagy az SHC felhasználói kézikönyveiben található bármely kijelentést a Gigaset Communications GmbH kijelentésének kell tekinteni.
Reméljük, megelégedéssel használja Gigaset készülékét.
- PL** Szanowny Kliencie,
Firma Gigaset Communications GmbH jest spadkobiercą prawnym firmy Siemens Home and Office Communication Devices GmbH & Co. KG (SHC), która z kolei przejęła segment produktów Gigaset od firmy Siemens AG. Wszelkie oświadczenia firm Siemens AG i SHC, które można znaleźć w instrukcjach obsługi, należy traktować jako oświadczenia firmy Gigaset Communications GmbH.
Życzymy wiele przyjemności z korzystania z produktów Gigaset.
- TR** Sayın Müşterimiz,
Gigaset Communications GmbH, Siemens AG'nin Gigaset işletmesini yürüten Siemens Home and Office Communication Devices GmbH & Co. KG (SHC)'nin yasal halefidir. Kullanma kılavuzlarında bulunan ve Siemens AG veya SHC tarafından yapılan bildiriler Gigaset Communications GmbH tarafından yapılmış bildiriler olarak algılanmalıdır.
Gigaset'ten memnun kalmanızı ümit ediyoruz.
- RU** Уважаемые покупатель!
Компания Gigaset Communications GmbH является правопреемником компании Siemens Home and Office Communication Devices GmbH & Co. KG (SHC), которая, в свою очередь, приняла подразделение Gigaset в свое управление от компании Siemens AG. Поэтому любые заявления, сделанные от имени компании Siemens AG или SHC и встречающиеся в руководствах пользователя, должны восприниматься как заявления компании Gigaset Communications GmbH.
Мы надеемся, что продукты Gigaset удовлетворяют вашим требованиям.

SIEMENS





Gigaset C470 IP / C475 IP

Gigaset

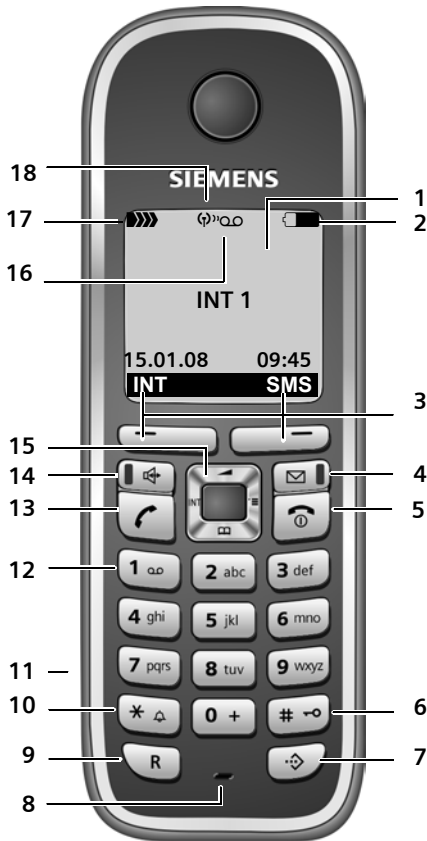
The handset at a glance

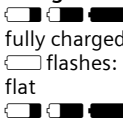
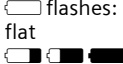

Handset keys

- 1 Display in idle status (example)
- 2 Charge status of the batteries
 (1/3 charged to fully charged)
 flashes: batteries almost flat
 flashes: batteries charging
- 3 Display keys (page 38)
- 4 Message key
 Opens calls and message lists
 Flashes: new message or new call

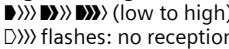
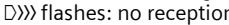

- 5 End call key, On/Off key
 End call, cancel function, go back one menu level (press briefly), back to idle status (press and hold), activate/deactivate handset (press and hold in idle status)
- 6 Hash key
 Keypad lock on/off (press and hold, page 37)
 Switch between upper/lower case letters and digits for text input (page 177)
- 7 Call-by-call list key (not for VoIP)
 Open call-by-call list
- 8 Microphone
- 9 Recall key
 Fixed line network:
 enter flash (press briefly)
 insert a pause (press and hold)
 VoIP: enter Flash (adjustable, page 147)
- 10 Star key
 Idle status: ringer tones on/off (press and hold)
 Fixed line network: switch between dial pulsing/touch tone dialling
 Editor: open special characters table
- 11 Connection socket for headset (page 24)
- 12 Key 1 (press and hold)
 Answer machine (Gigaset C475 IP only)/
 call network mailbox
- 13 Talk key
 Accept call, open last number redial list (press briefly in idle status), select connection type and start dialling (press briefly/press and hold after entering the number, page 30)
 SMS editor: send SMS
- 14 Handsfree key
 Change between speaker/handsfree mode
 Lights up: handsfree talking activated
 Flashes: incoming call
- 15 Control key (page 37)
- 16 Answer machine icon (Gigaset C475 IP)
 Answer machine switched on;
 Flashes: answer machine is recording a message or is being operated by another internal party
- 17 Signal strength
 (low to high)
 flashes: no reception
- 18 Eco mode activated (page 24)

Siemens Gigaset contact numbers:

For personal advice on our range of products and for repairs or guarantee/warranty claims call:

Service Centre UK: 08453 6708 12
 (local call cost charge)

Please have your proof of purchase ready when calling.

The base station at a glance



Base station key

1 Paging key

Lights up:

LAN connection active (phone is connected to router)

Flashes:

data transfer to LAN connection

Press **briefly**:

start paging (page 99), display IP address on handset

Press and **hold**:

set base station to registration mode (page 98)

Contents

The handset at a glance	1
The base station at a glance	2
Safety precautions	7
Gigaset C470 IP/C475 IP – More than just a telephone	9
VoIP – making calls via the Internet	10
First steps	11
Pack contents	11
Setting up the handset for use	11
Installing the base station	14
Connecting the base station	15
Making settings for VoIP telephony	18
Belt clip and headset	23
ECO DECT: Reducing the power consumption and transmission power of the base station	24
Menu trees	25
Phone menu	25
Web configurator menu	29
Making calls with VoIP and the fixed line network	30
Making an external call	30
Ending a call	32
Accepting a call	33
Calling Line Identification	33
Handsfree talking	36
Muting the handset	36
Operating the handset	37
Activating/deactivating the handset	37
Activating/deactivating the keypad lock	37
Control key	37
Display keys	38
Reverting to idle status	38
Menu guidance	39
Correcting incorrect entries	39
VoIP telephony via Gigaset.net	40
Search for subscribers in the Gigaset.net directory	40
Entering, editing and deleting own entry	43
Calling a Gigaset.net subscriber	43
Network services	44
Anonymous calling – withholding caller ID	44
Further network services for fixed line networks	45
Further network services for VoIP	47

Using the directory and lists	49
Directory/call-by-call list	49
Using online directories	53
Last number redial list	56
Opening lists with the message key	57
Making cost-effective calls	60
SMS (text messages)	61
Writing/sending an SMS	62
Receiving an SMS	64
Notification by SMS	66
SMS mailboxes	67
Setting SMS centres	68
SMS on a PABX	69
Activating/deactivating SMS function	69
SMS troubleshooting	69
Operating the base station answer machine	71
Operation via the handset	71
Activating/deactivating call screening	77
Setting up the answer machine	77
Assigning the answer machine to key 1 for fast access	78
Operating when on the move (remote operation)	79
E-mail notifications	81
Opening the incoming mail list	81
View the message header of an e-mail	83
View e-mail sender's address	83
Messenger	84
Establishing a connection, going online	85
Changing/checking your personal status, going offline	86
Opening the buddy list	87
Receiving messages	89
Writing and sending messages	91
Calling a buddy	92
Self-help with errors	93
Using the network mailbox	94
Activating/deactivating network mailbox, entering numbers	94
Configuring the (network) mailbox for fast access	95
Listening to messages on the network mailbox	96
Using several handsets	98
Registering handsets	98
De-registering handsets	99
Locating a handset ("paging")	99
Changing a handset's internal number	100
Changing the name of a handset	100
Making internal calls	101

Listening in to an external call	103
Using a handset as a room monitor	104
Handset settings	106
Changing the display language	106
Setting the display	106
Setting the screen picture	107
Setting the display backlight	107
Quick access to functions	108
Activating/deactivating auto answer	109
Changing the handsfree/earpiece volume	109
Changing ringer tones	110
Activating/deactivating advisory tones	111
Setting the alarm clock	112
Restoring the handset to the factory settings	113
Base station settings	114
Protecting against unauthorised access	114
Restoring the base station to the factory settings	114
Activating/deactivating music on hold	115
Activating/deactivating repeater mode	115
Setting the default connection	116
Updating the base station firmware	116
Making VoIP settings	118
Using the connection assistant	118
Changing settings without the connection assistant	118
Setting the phone's IP address in LAN	120
Activating/deactivating display of VoIP status messages	121
Checking the base station MAC address	121
Operating the base station on the PABX	122
Changing the dialling mode	122
Setting recall	122
Setting pauses	122
Switching temporarily to touch tone dialling (DTMF)	123
Web configurator – configuring the telephone via a PC	124
Connect the PC with the telephone's Web configurator	124
Logging in, setting the Web configurator language	125
Logging off	126
Structure of the Web pages	126
Opening Web pages	128
Setting phone with Web configurator	129
IP Configuration	130
Configuring telephone connections	132
Optimising voice quality for VoIP connections	140
Setting the telephone default connection	144
Assigning send and receive numbers to handsets	144
Assigning answer machine receive numbers (Gigaset C475 IP)	145

Call Forwarding to activate VoIP connections	146
Setting DTMF signalling for VoIP	146
Defining recall key functions for VoIP (hook flash)	147
Defining local communication ports for VoIP	147
Configuring call forwarding via VoIP	148
Setting area code predialling	148
Defining dialling plans – cost control	149
Activating/deactivating network mailbox, entering numbers	151
Saving messenger access data	152
Making e-mail settings	154
Activating/deactivating info services	155
Selecting and registering online directories for access	155
Changing internal handset numbers and names	156
Loading and deleting handset directories to/from the PC	157
Activating VoIP status message display	159
Starting a firmware update	159
Activating/deactivating the automatic version check	161
Copy date and time from time server	161
Querying the phone status	162
Appendix	163
Care	163
Contact with liquid	163
Questions and answers	163
Checking service information	171
Service (Customer Care)	172
Authorisation	172
Guarantee Certificate	
United Kingdom	173
Specifications	174
Icons	175
Example of a menu input	176
Example of multiple line input	176
Writing and editing text	177
Gigaset C470 IP/C475 IP – Free software	179
Accessories	186
Glossary	189
Index	202
Mounting the charging cradle to the wall, connecting the charging cradle	214
Mounting the base station to the wall	215

Safety precautions

Warning:

Read the safety precautions and the user guide before use.

Explain their contents and the potential hazards associated with using the telephone to your children.



Only use the mains adapter supplied, as indicated on the underside of the base station or charging cradle.



Only use the **recommended, rechargeable batteries** (page 174), i.e. never use a conventional (non-rechargeable) battery or other battery types as this could result in significant health risks and personal injury.

Batteries should not be disposed of in general household waste. Observe the local waste disposal regulations, details of which can be obtained from your local authority or the dealer you purchased the product from.



The operation of medical appliances may be affected. Be aware of the technical conditions in your particular environment, e.g. doctor's surgery.



Do not hold the rear of the handset to your ear when it is ringing or when the handsfree function is activated. Otherwise you risk serious and permanent damage to your hearing.

The handset may cause an unpleasant humming noise in hearing aids.



Do not install the base station or charging cradle in bathrooms or shower rooms. The handset, base station and charging cradle are not splashproof (page 163).



Do not use the phone in environments with a potential explosion hazard, e.g. paint shops.



If you give your Gigaset to someone else, make sure you also give them the user guide.



Please remove faulty base stations from use or have them repaired by Siemens Service, as they could interfere with other wireless services.



All electrical and electronic products should be disposed of separately from the municipal waste stream via designated collection facilities appointed by the government or the local authorities.

This crossed-out wheeled bin symbol on the product means the product is covered by the European Directive 2002/96/EC.

The correct disposal and separate collection of your old appliance will help prevent potential negative consequences for the environment and human health. It is a precondition for reuse and recycling of used electrical and electronic equipment.

For more detailed information about disposal of your old appliance, please contact your local council refuse centre or the original supplier of the product.

Warning:

When the keypad lock is active, you cannot call emergency numbers.

Please note:

Not all of the functions described in this user guide are available in all countries.

Gigaset C470 IP/C475 IP – More than just a telephone

Your phone lets you make calls both via the fixed line network and (cost effectively) via the Internet (VoIP) **without using a PC**. – Your phone can do much more besides:

- ◆ **Press a button** each time you make a call to indicate whether you want to call via the fixed line network or the Internet (page 30).
- ◆ Register up to **six** handsets on your base station. With your base station, you can simultaneously conduct two calls via VoIP and one call via the fixed line network.
- ◆ **Multiline**: Create up to six VoIP accounts with different VoIP providers. Together with your fixed line number and the Gigaset.net number, your phone can then be reached via up to **eight different phone numbers**.
- ◆ Assign each handset its own VoIP number as a send and receive number. If a member of your family is called on their VoIP number, only their handset will ring (page 144).
- ◆ You can also use the VoIP accounts with different providers for cost control purposes. When dialling, specify the VoIP connection/the VoIP account you want to use for its lower rates (page 31).
- ◆ Setting dialling plans for phone numbers or area codes enables you to automate the selection of the most cost-effective VoIP connection (page 149).
- ◆ Determine which of your phone numbers should be answered by the Gigaset C475 IP answer machine (page 145).
- ◆ Use Gigaset.net for VoIP calls. Connect your phone to the mains power supply and the Internet, and enjoy free phone calls on Gigaset.net – without making any further settings (page 40).
- ◆ Configure the phone connection for VoIP without a PC. Your phone's connection assistant downloads general data about your VoIP provider from the Internet and guides you through entering your personal data (VoIP/SIP account). This makes it easy for you to start using VoIP (page 19).
- ◆ If necessary, make any further VoIP settings on a PC. The phone features a Web interface (**Web configurator**) that can be accessed via your PC's Web browser (page 124).
- ◆ Use **instant messaging** on your handset. Go online and see which of your messenger contacts (buddies) are also online. Exchange SMS messages with your buddies or simply give them a call (page 84). A free messenger account is already set up for you on the Gigaset.net Jabber server (page 153).
- ◆ Let your phone tell you, **without requiring a PC**, about new **e-mail** messages in your mailbox (page 81). Use your handset to delete old e-mail messages from your mailbox.
- ◆ Make sure your phone is always up-to-date. Keep yourself informed about **firmware updates** on the Internet and download them onto your phone (page 116).
- ◆ You can reduce the transmission power by activating eco mode (page 24).

Your Gigaset C470 IP/C475 IP has a protected operating system that offers **increased security against viruses** from the Internet.

Enjoy using your new phone!

VoIP – making calls via the Internet

With VoIP (**V**oice **o**ver **I**nternet **P**rotocol), your calls are not made via a fixed connection as in the telephone network, but rather they are transmitted via the Internet in the form of data packets.

You can take advantage of all the benefits of VoIP with your phone:

- ◆ You can make cost-effective calls in high voice quality with callers on the Internet, the fixed line network or the mobile phone network.
- ◆ VoIP providers will give you personal numbers, with which you can be reached from the Internet, the fixed line network and any mobile phone network.

To be able to use VoIP, you need the following:

- ◆ A broadband Internet connection (e.g. DSL) with flat rate (recommended) or volume-based price.
- ◆ Internet access, i.e. you need a router that will connect your phone to the Internet.

You can find a list of recommended routers on the Internet at:

www.siemens.com/gigasetcustomercare

Once you are on the Web page, open the FAQ page and select "Gigaset C470 IP" or "Gigaset C475 IP". Search for "Router", for example.

- ◆ Access to the services of a VoIP provider. You can open up to six accounts with **different** VoIP providers.

First steps

Pack contents

The pack contains:

- ◆ one Gigaset C470 IP/C475 IP base station
- ◆ one Gigaset C47H handset
- ◆ one mains adapter for the base station
- ◆ one charging cradle incl. mains adapter
- ◆ one phone cable
- ◆ one Ethernet cable (LAN cable)
- ◆ two batteries
- ◆ one battery cover
- ◆ one belt clip
- ◆ one quick guide

Firmware updates:

Your telephone is supplied with the firmware version 097 of higher.

Whenever there are new or improved functions for your Gigaset C470 IP/C475 IP, base station firmware updates will be made available for you to download to your phone (page 116). If this results in operational changes to your phone, a new version of this user guide will be published on the Internet at

www.siemens.com/gigaset

Setting up the handset for use



The display is protected by a plastic film. **Please remove the protective film!**

Inserting the batteries

Warning:

Only use rechargeable batteries (page 174) recommended by Siemens Home and Office Communication Devices GmbH & Co. KG. Never use a conventional (non-rechargeable) battery or other battery types as this could result in significant health risks and personal injury. For example, the batteries could explode. The phone could also malfunction or be damaged as a result of using batteries that are not of the recommended type.

Setting up the handset for use

- ▶ Insert the batteries the right way round (see figure).
The polarity is indicated in/on the battery compartment.



The handset switches on automatically. You will hear a confirmation tone.

Closing the battery cover

- ▶ First insert the battery cover at the top.
- ▶ Then press the cover until it clicks into place.

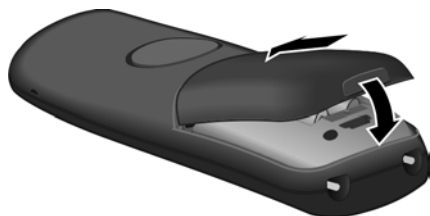

Opening the battery cover

- ▶ Place your fingertip in the cavity on the casing and pull the battery cover upwards.

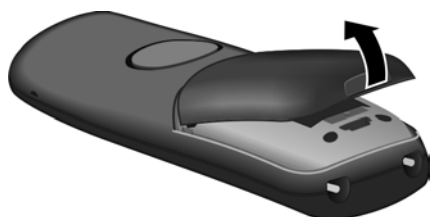

Connecting the charging cradle

The charging cradle is designed to be operated in enclosed, dry areas at temperatures ranging from +5 °C to +45 °C.

Instructions on how to connect the charging cradle and mount it on the wall (if required) can be found on page 214.

- ▶ To charge the batteries, leave the handset in the charging cradle.

Please note:

- Only place the handset in the charging cradle that is intended for it.
- If the handset has turned itself off because the batteries are flat and is then placed in the charging cradle, it will turn itself on automatically.

For questions and problems see page 163.

Initial charging and discharging of batteries

If the handset is activated, the flashing battery icon  in the top right of the display indicates that the batteries are being charged.

During handset operation, the battery icon indicates the charge status of the batteries (page 1).

The correct charge status can only be displayed if the batteries are first fully charged **and** discharged through use.

- ▶ To do this, leave the handset in the charging cradle without interruption until the battery icon stops flashing in the display (around 5 hours).
- ▶ Once the batteries are fully charged, remove the handset from the charging cradle and do not put it back again until the batteries are fully discharged.

Please note:

After the first battery charge **and** discharge, you may place your handset in the charging cradle after every call.

Please note:

- ◆ Always repeat the charging and discharging procedure if you remove the batteries from the handset and reinsert them.
- ◆ The batteries may warm up during charging. This is not dangerous.
- ◆ After a while the charge capacity of the batteries will decrease for technical reasons.

Please note:

You will find explanations for the symbols and typographical conventions used in this user guide in the appendix, page 175.

Setting the date and time

The date and time must be set in order to have the correct time for incoming calls and to be able to use the alarm clock and calendar.



Please note:

The address of a time server on the Internet is stored on your telephone. The date and time are taken from this time server provided that the base station is connected to the Internet and synchronisation with the time server is activated (page 161). Manual settings are overwritten in this case.







If the date and time on the phone have not yet been set, the **Time** display key will appear.

Manual setting:





You can use the menu at a later point to enter the date and time.

- ▶ Press **Time** or open the  →  **Settings** → **Date/Time** menu.
- ▶ Change multiple line input:

Date:

Enter the day, month and year in 6-digit format, e.g.       for 07/01/2008.

Installing the base station**Time:**

Enter hours and minutes as 4 digits, e.g.     for 07:15 a.m.

 Press the display key

The date and time are shown in the handset's idle display (page 1).

Setting the area codes

To be able to call back a caller using the calls list (page 58), the **area code** ("local area code") in which your phone is being used must be stored. If your phone is in a "multiple area code" area, the **extra codes** for this area must also be stored.

Area Code

 →  **Settings** →  **Telephony** →  **Area Code**



 Enter the local area code.

 Press the display key.

 Press and **hold** (idle status).

Extra Codes

 →  **Settings** →  **Telephony** →  **Extra Codes**

 Select an entry and press .

 Enter the extra code.

 Press the display key.

Repeat the above steps until all extra codes for your area have been entered. A maximum of 5 extra codes can be stored.

 Press and **hold** (idle status).

Registering the handset to the base station

Your handset is registered to the base station by default.

Instructions on how to register additional handsets with the base station and make free internal calls can be found from page 98.

Installing the base station

The base station is designed for use in closed, dry rooms with a temperature range of +5 °C to +45 °C.

► Place or hang the base station in a central position in your flat or house.

Instructions for mounting the base station on the wall can be found page 215.

Please note:

- ◆ Never expose the telephone to heat sources, direct sunlight or other electrical appliances.
- ◆ Protect your Gigaset from moisture, dust, corrosive liquids and vapours.

Connecting the base station

In order to be able to make calls with your phone via the fixed line network and via VoIP, you must connect the base station to the fixed line and the Internet, see Figure 1.

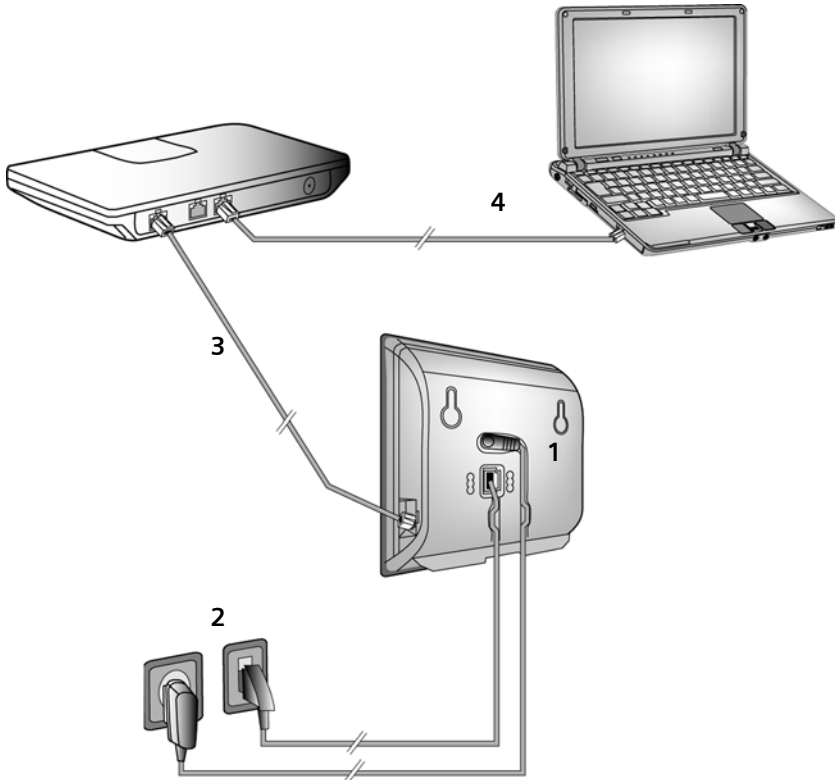
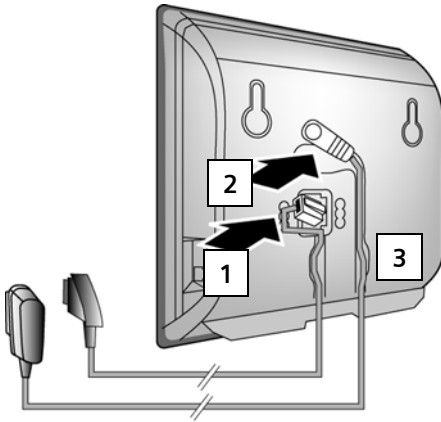

Figure 1 Connecting the phone to the fixed line and the Internet

Follow the steps in the order given below (see Figure 1):

1. Connect the phone cord and power lead to the base station.
2. Connect the base station to the fixed line network and the mains power supply.
3. To connect the base station to the Internet, first connect the base station to the router (connection via router and modem or via router with integrated modem).
4. Connect the PC and router (optional) – for advanced configuration of the base station (see page 124).

1. Connect the phone cord and power lead to the base station



1. Insert the phone cord into the lower connection socket at the rear of the base station.
2. Insert the power lead of the mains adapter into the upper connection socket at the rear of the base station.
3. Push both cables into the appropriate cable channels.

2. Connect the base station to the fixed line network and the mains power supply

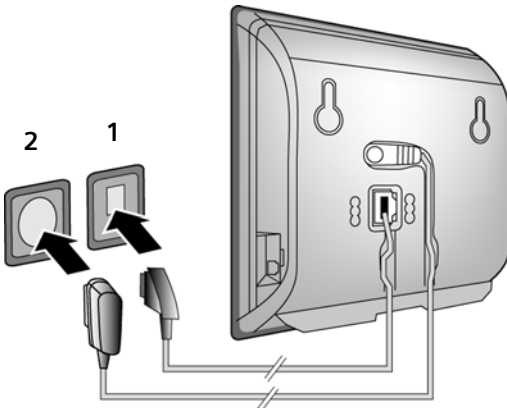

1. Insert the phone cord into the fixed line network connection socket.
2. **Then** insert the mains adapter into the mains socket.

Please note:

- ◆ Keep the mains adapter **plugged in at all times** for operation, as the phone does not work without mains connection.
- ◆ Only use the mains adapter and phone cord **supplied**.
- ◆ If you buy a replacement phone cord from a retailer, pay attention to the wiring of the phone jack.

Correct phone jack assignment

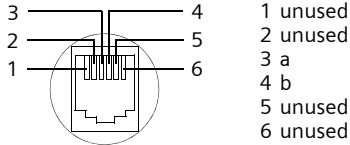

You can now use your phone to make calls via the fixed line network and can be reached on your fixed line number.

The answer machine on the Gigaset C475 IP has a standard announcement when recording mode is active (page 71).

3. Connect the base station with the router (Internet)

For Internet access you need a router connected to the Internet via a modem (this may be integrated in the router).

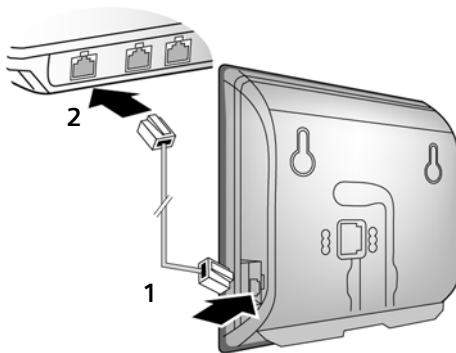

1. Connect one Ethernet cable plug into the LAN socket at the side of the base station.
2. Then insert the second Ethernet cable plug into a LAN socket on the router.

As soon as the cable connecting the phone and router is plugged in, the key lights up on the front of the base station (paging key).

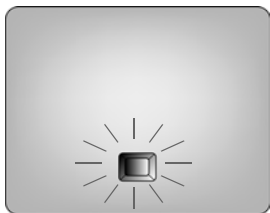

You can now establish VoIP connections within Gigaset.net (page 40).

Making settings for VoIP telephony

Before you can use the Internet (VoIP) to phone any other numbers on the Internet, the fixed line network or the mobile phone network, you need the services of a VoIP provider who supports the VoIP SIP standard.

Precondition: You have registered with such a VoIP provider (e.g. via your PC) and set up at least one VoIP account.

The following phone settings are necessary in order for you to use VoIP. You can obtain the following information from your VoIP provider:

- ◆ Your user name with the VoIP provider, if this is required by the VoIP provider
- ◆ Your registration name
- ◆ Your password with the VoIP provider
- ◆ VoIP provider general settings

The connection assistant will help you with the settings.

Automatic configuration:

If your provider supports "automatic configuration", you will receive an "auto configuration code" from your provider instead of an authentication name and password.

You will need to set the VoIP configuration with the auto-configuration code via the Web configurator on the base station (see page 124 "Connect the PC with the telephone's Web configurator" and page 133 "Configuring the VoIP connection")



Starting the connection assistant

Precondition: The base station is connected to the mains power supply and a router. Your router is connected to the Internet (page 17).

Tip: Leave VoIP activated as the default connection for your telephone (default setting, page 116). The telephone then attempts to establish a connection directly to your VoIP provider's server after the connection assistant is closed. If incorrect/incomplete information means that the connection cannot be established, messages will be displayed (page 22).

Please note:

Your phone is preconfigured for dynamic assignment of the IP address. In order for your router to "recognise" the phone, dynamic IP address assignment must also be activated on the router, i.e. the router's DHCP server is activated. Turn to page 120 to find out how to assign your phone a static IP address if necessary.

As soon as the handset battery is sufficiently charged, the message key  on the handset will flash (approx. 20 minutes after you have put the handset in the charging cradle). Press the message key  to start the connection assistant.

You will see the following display:



Yes

Press the display key to start the connection assistant.



Enter the system PIN (default is 0000) and press **OK**.

If you press **No**, the procedure that follows is described under "Entering your name in the Gigaset.net directory" on page 21.

Please note:

The connection assistant will also start automatically if you try to establish a connection via the Internet before you have made the necessary settings.



You can also call up the connection assistant at any time via the menu (page 118).

Downloading VoIP provider data

The phone establishes a connection with the Siemens server on the Internet. Various profiles with general access data for different VoIP providers can be downloaded here.

After a brief period you will see the following display:



-  Select country (press up/down on the control key) and press **OK**. VoIP providers for which VoIP profiles are available will be displayed.
-  Select your VoIP provider and press **OK**.

The necessary general access data for your VoIP provider will be downloaded and saved on the phone.

If the data for your VoIP provider is not available for download, press the  display key twice. You can then carry out the following steps with the connection assistant. You must then make the settings needed for the VoIP provider using the Web configurator (page 133). Your VoIP provider will supply you with this data.

Entering user data for your first VoIP account

Enter the VoIP user data for the first VoIP account. Your VoIP provider will supply you with this data.

You can enter five additional VoIP accounts (VoIP phone numbers) via the Web configurator at a later stage (page 132). Your phone (together with your fixed line number) can then be reached on up to seven different phone numbers. You can assign the phone numbers to the individual handsets that are registered with the base station as send and receive numbers (page 144).

Username:

Enter the user name and press **OK** if this is required by your provider.

Authent. Name:

Enter the registration name and press **OK**.

Authent. Password:

Enter password and press **OK**.

Please note:

When making these entries, please remember the VoIP user data is case sensitive. When you enter text, the first letter is capitalised by default. If necessary, press and hold the  key to switch between upper and lower case and numbers.

If you have made all the required entries, the message "Connection data complete" will appear on the display.

Then the Gigaset.net assistant is started.

Entering your name in the Gigaset.net directory

With Gigaset.net you can call other Gigaset.net users directly over the Internet free of charge, without setting up an account with a VoIP provider and without making any further settings. You can find Gigaset.net subscribers by carrying out a name search in the Gigaset.net directory (page 40).

The following appears in the handset's display:

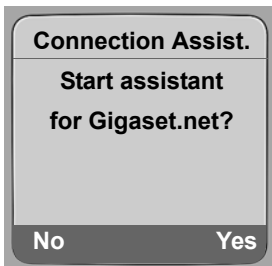

Yes Press the display key.

Enter your **Gigaset.net** name:

Enter the name that you would like to be listed under in the Gigaset.net directory and press **OK**. The name may contain up to 25 characters.

A connection to the Gigaset.net server is established.

If there is already an entry under this name, you will receive a message to this effect and you will be asked to enter a name again.

If an entry in the Gigaset.net directory is successful, the message "Your user name is successfully added to Gigaset.net!" is displayed briefly.

If the attempt to create the entry fails (e.g. because the phone is not connected to the Internet), a message to this effect is displayed briefly (see page 22). You can then create the entry later via the Gigaset.net directory (see page 43).

Completing the VoIP settings

After the entries have been completed, the handset reverts to idle status.

If all the settings are correct and if the phone can establish a connection to the VoIP server, then the internal name of the handset will be displayed (example):

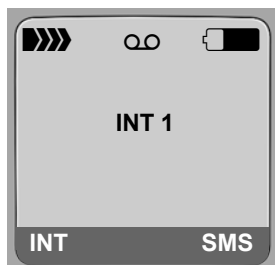

You can now use your phone to make calls via the fixed line network and the Internet. Callers can reach you on your fixed line number and your VoIP number.

Please note:

- To ensure that you can always be reached via the Internet, the router must be permanently connected to the Internet.
- If you try to make a call via a VoIP connection that is not configured correctly, the following VoIP status message will appear on the display: **IP configuration error: xxx** or **VoIP config.error: xxx** (xxx = VoIP status code). The various status codes and their respective meanings can be found on page 168.

No connection to the Internet/VoIP server

If one of the following messages is displayed instead of the internal name after the connection assistant is closed, errors have occurred:

- ◆ **Server not accessible!**
- ◆ **Provider registration failed!**

Below you will find possible causes and measures you can take.



Server not accessible!

The phone has no connection to the Internet.

- ▶ Check the cable connection between the base station and the router (the LED on the base station must light up) and the connection between the router and the Internet connection.
- ▶ Check whether the phone is connected to the LAN.
 - It may not have been possible to dynamically assign an IP address to the phone
 - or
 - You have assigned a static IP address to the phone that has either already been assigned to another LAN subscriber or does not belong to the router's address block.
- ▶ Press the paging key on the base station. The IP address appears on the handset display.
- ▶ Press the talk key on the handset to end paging call.

- ▶ Start the Web configurator with the IP address.
- ▶ If no connection can be established, change the settings on the router (activate DHCP server) or the phone's IP address.

Provider registration failed!

- ◆ Your personal data for registering with the VoIP provider may have been entered incompletely or incorrectly.
 - ▶ Check your entries for **Username**, **Authent. Name** and **Authent. Password**. In particular, check your use of upper and lower case.
To do this, open the following menu on your handset:
 →  **Settings** → **Telephony** → **VoIP** (Enter system PIN) → **Provider Registr.**
(see page 119)
- ◆ The server address for the VoIP server has not yet been entered, or has been entered incorrectly.
 - ▶ Start the Web configurator.
 - ▶ Open the following Web page: **Settings** → **Telephony** → **Connections**.
 - ▶ Click the **Edit** button next to the first VoIP connection.
 - ▶ Edit the server address where necessary.

Please note:

If port forwarding is activated on your router for the ports that have been registered as the SIP port (Standard 5060) and the RTP port (Standard 5004), it is advisable to deactivate DHCP and assign the phone a static IP address (otherwise you may not be able to hear the other party during VoIP calls):

- Assign IP address via the handset menu:

 →  **Settings** → **Base** → **Local Network**

Or

- Assign IP address via the Web configurator:

- ▶ Open the following Web page: **Settings** → **IP Configuration**.
- ▶ Select **IP address type**.

Please note that the IP address and subnet mask depend on the router's address block.

You must also enter the standard gateway and DNS server. The IP address for the router is generally entered here.

Belt clip and headset

By using a belt clip and headset (optional) you can easily make your handset a constant companion both inside the building and in its immediate vicinity.

Attaching the belt clip

The handset has notches at the top and on each side (level with the loudspeaker) for attaching the belt clip.

- ▶ Press the belt clip onto the back of the handset so that the protrusions on the belt clip engage with the notches.

Belt clip and headset

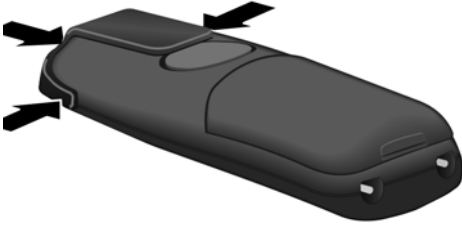

Connection socket for headset

You can connect various headset types (with 2.5 mm jack connector), including HAMA Plantronics M40, MX100 and MX150.

A compatibility list of tested headsets is available on the Internet at:

www.plantronics.com/productfinder

ECO DECT: Reducing the power consumption and transmission power of the base station

The base station of your phone is an ECO DECT base station, this means that:

- ◆ The base station uses less power because it is equipped with a power-saving mains adaptor.
- ◆ The reduction of the handset's transmission power is dependent on the handset's proximity to the base station.
- ◆ The base station can also be switched to eco mode. Eco mode reduces the transmission power and power consumption of the base station. This can be set on your handset.

Activating/deactivating eco mode

Precondition: Repeater support must be deactivated.

 →  **Settings** → **Base** → **Add. Features**

Eco Mode Select and press **OK** ( = on).

Eco mode enables an additional reduction in the transmission power of the **Gigaset C47H** handset. If, with eco mode activated, the transmission power of both the base station and the handset is reduced, the  icon is shown in the top line of the display.

Please note:

- Activating eco mode reduces the range of the base station.
- Eco mode and repeater support cancel each other out, i.e. both functions cannot be used at the same time.

Menu trees

Phone menu

Open the main menu on your phone by right-clicking the control key when the handset is in idle status: .

There are two ways to select a function:

Using number combinations ("shortcut")

- ▶ Enter the number combination that is in front of the function in the menu tree.

Example:     for "Set handset language".

Scrolling through the menus

- ▶ Scroll to the function with the control key  (press up or down) and press **OK**.

1 Messaging

1-1	SMS	An SMS mailbox (general or private) activated without a PIN			page 61
		1-1-1	New SMS		page 62
		1-1-2	Incoming (0)		page 64
		1-1-3	Outgoing (0)		page 63
		An SMS mailbox activated with a PIN or 2-3 mailboxes			
		1-1-1	Mailbox	1-1-1-1	New SMS page 62
				1-1-1-2	Incoming (0) page 64
				1-1-1-3	Outgoing (0) page 63
		1-1-2	Mailbox 1	1-1-2-1	New SMS page 62
		to	Mailbox 2	to	
		1-1-4	Mailbox 3	1-1-4-1	
				1-1-2-2	Incoming (0) page 64
				to	
				1-1-4-2	
				1-1-2-3	Outgoing (0) page 63
				to	
				1-1-4-3	

Phone menu

		1-1-6	Settings	1-1-6-1	Service Centres	page 68
				1-1-6-2	SMS Mailboxes	page 67
				1-1-6-3	Notify Number	page 66
				1-1-6-4	Notify Type	page 66
				1-1-6-6	Subscribe to SMS	page 62
1-2	E-mail					page 81
1-3	Messenger	1-3-1	Buddies			page 87
		1-3-2	User Status	1-3-2-1	Change Status	page 87
				1-3-2-2	Info	page 87
		1-3-3	Messages			page 89

2  Sel. Services

2-1	VoIP	2-1-6	Call Divert			page 47
		2-1-7	Call Waiting			page 47
2-2	Fixed Line	2-2-6	Call Divert			page 45
		2-2-7	Call Waiting			page 45
2-3	Ringback Off					page 46
2-4	Always anon.					page 46
2-5	Next Call					page 46

3  Alarm Clock page 112

4  Add. Features

4-3	Room Monitor					page 104
-----	--------------	--	--	--	--	----------

5  Settings

5-1	Date/Time					page 13
5-2	Audio Settings	5-2-1	Handset Volume			
		5-2-2	Ringer Settings	5-2-2-1	Ext. Calls	page 110
				5-2-2-2	Internal Calls	
				5-2-2-3	All	
		5-2-3	Advisory Tones			page 111
5-3	Display	5-3-1	Screen Picture			page 107
		5-3-2	Colour Scheme			page 106
		5-3-3	Contrast			page 106
		5-3-4	Backlight			page 107
5-4	Handset	5-4-1	Language			page 106
		5-4-2	Auto Answer			page 109
		5-4-3	Register H/Set			page 98
		5-4-4	Reset Handset			page 113
5-5	Base	5-5-1	Calls List Type	5-5-1-1	Missed Calls	page 58
				5-5-1-2	All Calls	
		5-5-2	Music on hold			page 115
		5-5-3	System PIN			page 114
		5-5-4	Base Reset			page 114
		5-5-5	Add. Features	5-5-5-1	Repeater Mode	page 115
				5-5-5-4	Eco Mode	page 24
		5-5-6	Local Network			page 120
		5-5-8	Software Update			page 116

5-6	Voice Mail	5-6-1	Local AM (only on C475 IP base station)	5-6-1-1	Ans Machine	page 78
				5-6-1-2	Call Screening	page 77
				5-6-1-3	Announcements	page 73
				5-6-1-4	Message Length	page 78
				5-6-1-5	Record Quality	page 78
				5-6-1-6	Ring Delay	page 77
		5-6-2	Network AM(s)	5-6-2-1	Net AM: Fxd. line	page 94
				5-6-2-2	Net AM: IP1	
					:	(dependent on the number of configured VoIP phone numbers and receive numbers on the handset)
				5-6-2-7	Net AM: IP6	
		5-6-3	Set Key 1		Local AM (only on C475 IP base station)	page 78
					Net AM: Fxd. line	page 95
					Net AM: IP1	page 95
					:	(dependent on the number of configured VoIP phone numbers and receive numbers on the handset)
					Net AM: IP6	page 95
5-7	Telephony	5-7-1	Default Line	5-7-1-1	VoIP	page 116
				5-7-1-2	Fixed Line	
		5-7-2	Connection Assist.			page 118
		5-7-6	Fixed Line	5-7-6-1	Dialling Mode	page 122
				5-7-6-2	Recall	page 122
		5-7-7	VoIP	Enter system PIN.	Show Stat. on HS	page 121
					Select Provider	page 118
					Provider Registr.	page 119

Web configurator menu

Home		page 124
Settings		
	IP Configuration	page 130
	Telephony	
	Connections	page 132
	Audio	page 140
	Number Assignment	page 144
	Call Forwarding	page 146
	Dialling Plans	page 149
	Network Mailbox	page 151
	Advanced Settings	page 146
	Messaging	
	Messenger	page 152
	E-Mail	page 154
	Services	page 155
	Handsets	page 156/ page 157
Miscellaneous	page 159 to page 159	
Status		
Device	page 162	

Making calls with VoIP and the fixed line network

Making an external call

External calls are calls made via the public telephone network (fixed line network) or via the Internet (VoIP). You generally decide which connection type you want to use for a specific call when you dial the number.



Please note:



- You can conduct up to three separate external calls via your base station (using different handsets): two calls via VoIP and one via the fixed line network.
- You can define dialling plans for certain numbers or area codes by determining the connection and therefore the billing method to be used (cost control, see page 149) when these numbers are dialled.
- Dialling with the directory (page 49), quick dial keys (page 108) or last number redial list (page 56) saves repeated keying of phone numbers. You can modify or add to these numbers on a call-to-call basis.
- If you use VoIP to make a call to the fixed line network, you may also have to dial the area code for local calls (depending on the VoIP provider). You can avoid having to dial your own area code by entering it into the configuration (page 148). Your area code is then added automatically when you make local calls.

Use the talk key to select the type of connection and make the call

By briefly pressing or pressing and holding the call key , you can determine the type of connection for the call you want to make (fixed line network or VoIP).

Precondition: You enter the number without a line suffix (page 31) and have not defined any dialling plans for this number.

  Enter number (without suffix) and **briefly press/press and hold** the talk key. A default connection is established on your phone (fixed line network or VoIP, page 116/ page 144).

- ▶ **Briefly** press the talk key  if you want to make a call via this default connection.
- ▶ Press and **hold** the talk key  if you want to make the call via the other connection type.

If you have assigned a number of VoIP numbers to your phone, you can define which VoIP number (VoIP account) is used for external calls from each specific handset (handset send number, page 144).

Please note:

If you are using a GAP compatible handset other than the Gigaset handsets C47H, S67H, S68H, SL37H, S45 and C45, every call will be made via the standard connection, even if you press and hold the call key. If you want to use the non-default connection to make a call, enter a star (*) at the end of the number.

Selecting the connection type using display keys and making a call

Precondition: The display keys on your handset have been assigned **FixedLine** and/or **IP** (page 108).

FixedLine / **IP**

Press the display key to select the connection type.



Enter the number or select from the directory.



Press the talk or handsfree key.

The number will always be called via the selected connection type.

Please note:

If you have pressed the **IP** before dialling and ...

- ... dialled the number with suffix #1 to #6, your call will be made via the VoIP account assigned to the suffix. The number will not be dialled if the suffix is invalid (e.g. no VoIP connection assigned).
- ... dialled the number without a suffix or with the suffix #0, your call will be made via the handset's VoIP send number.

Do not enter a suffix if you have pressed the display key **FixedLine** prior to dialling. Otherwise the suffix will be dialled together with the number over the fixed line network. This may cause errors!

Select and dial a connection via your line suffix

You can configure up to six VoIP numbers on your phone in addition to the fixed line network number and the Gigaset.net number. A (line) suffix is assigned to each number (line) of your phone:

- ◆ the fixed line number has the suffix #0
- ◆ VoIP numbers have the suffixes #1 to #6 (page 133)
- ◆ and the Gigaset.net number has the suffix #9

When dialling, you can use this line suffix to specify the connection via which you would like to call or be charged.



Enter the number of the party you wish to call.



Add the suffix for the connection (your phone number) through which you wish to make and pay for the call.



Press the talk key.

The connection is always made via the line with the assigned suffix, regardless of whether you press the call key  **briefly** or press and **hold**.

Example: If you enter the number 1234567890#1 and press the talk key , the number 1234567890 will be dialled via the first VoIP connection in the configuration.



Please note:

If you specify a suffix for which no VoIP connection is configured in your base station, the VoIP status code 0x33 will be displayed. The number will not be dialled.

Ending a call

Entering an IP address

You can also dial an IP address instead of a phone number using VoIP.

- ▶ Press the star key  to separate the sections of the IP address (e.g. 149*246*122*28).
- ▶ If necessary press the hash  key to attach the SIP port number of the person you are calling to the IP address (e.g. 149*246*122*28#5060).

You **cannot** dial IP addresses using a line suffix.

Cancelling the dialling operation

You can cancel the dialling operation with the end call key .

Dialling emergency numbers – defining dialling plans

You can use the Web configurator to block certain numbers or to define which of your numbers (fixed line network, VoIP) should be used to call specific numbers (**Dialling Plans**, see page 149).

If you enter a number that has a defined dialling plan, the call will be made via the line defined in the dialling plan – regardless of whether the call key is pressed briefly or pressed and held. Any automatic area code will **not** be prefixed to the number.

Emergency numbers

Dialling plans for emergency numbers (e.g. the **local** emergency service number) are factory-set for certain countries. Emergency calls are then always made via the fixed line network.

You cannot delete or deactivate these dialling plans. However, you can change the connection through which each emergency number should be called (e.g. if the phone is not connected to the fixed line network). You must make sure that the VoIP provider for the selected connection supports emergency calls.

If your phone does not have default dialling plans for emergency calls, you should define the rules yourself (page 149). Assign them to a connection that you know supports emergency calls. Emergency calls are always supported by fixed line networks.

Please note: If no rules are defined for emergency numbers and you have programmed an automatic local area code (page 148), the code will be prefixed to emergency numbers as soon as they are dialled via a VoIP connection.

Please note:

Emergency numbers cannot be dialled if the keypad lock is activated. Before dialling, press **and hold** the hash key , to release the keypad lock.

Ending a call



Press the end call key.



Accepting a call

The handset indicates an incoming call in three ways: by ringing, by a display on the screen and by the flashing handsfree key .

Please note:

Only calls to receive numbers that are assigned to your handset will be signalled (page 144). Calls made to a number that is not assigned to a handset as a receive number will not be signalled on any handset.

You can accept the call by:

- ▶ Pressing the talk key .
- ▶ Pressing the handsfree key .
- ▶ Gigaset C475 IP: Press the display key  to forward the call to the answer machine (page 76).

If the handset is in the charging cradle and the **Auto Answer** function is activated (page 109), the handset will take a call automatically when you lift it out of the cradle.

If the ringer tone is intrusive, press the **Silence** display key. You can accept the call so long as it is displayed on the screen.

Please note:

You can reject VoIP calls by pressing the end call key . The caller receives an appropriate message (depending on the provider). Pressing the end call key on an incoming call from the fixed line network will cancel the ringer tone (same as **Silence**).

Calling Line Identification

When you receive a call from the Internet, the caller's number and/or the name they have specified is displayed on the screen.

When you receive a call from the fixed line network, the caller's number is displayed on the screen if the following conditions are met:

- ◆ Your fixed line network provider supports CLIP, CLI:
 - CLI (Calling Line Identification): number of the caller is transmitted
 - CLIP (Calling Line Identification Presentation): the caller's number is displayed.
- ◆ You have arranged CLIP with your network provider.
- ◆ The caller has arranged CLI with the network provider.

If the phone number is identified and the caller's number is saved in your handset's local directory, the name will be displayed from the directory.

If the caller's number is not saved in the local directory the caller's surname and first name will be displayed from the currently installed online directory. **Precondition:** You have activated this option (see Web configurator page 155).

Calling Line Identification

Call display

You can use the display to determine whether the call is for your fixed line network number or one of your VoIP numbers.

Calls to your fixed line number

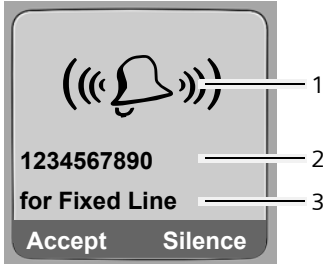

Calls to one of your VoIP numbers

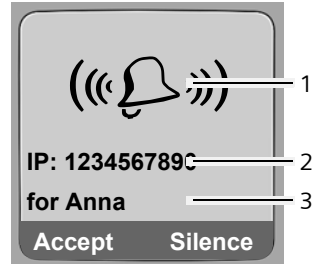

- 1 Ringer tone icon
- 2 Number or name of caller
- 3 Receive number: indicates which of your phone numbers the caller has dialled. Assign the name when you are configuring the phone with the Web configurator (page 134/page 139). For calls from Gigaset.net, for Gigaset.net is displayed.

Instead of **Accept** you may see the icon  (forward call to integrated answer machine, see page 76) above the left display key on the Gigaset C475 IP.

Adopting the name from the online directory

You can display the name under which the caller is saved in the online directory.

Preconditions:

- ◆ The provider of the online directory you have set for your telephone (page 155) supports this function.
- ◆ You have activated the "display caller name" function via the Web configurator (page 155).
- ◆ The caller has authorised Calling Line Identification and has not suppressed the function.
- ◆ Your telephone is connected to the Internet.
- ◆ The caller's number is not saved in the handset's local directory.

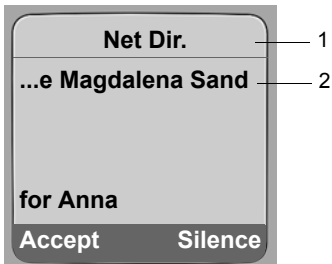

Display when Calling Line Identification is withheld

The caller's name and/or number will not be displayed if the caller has suppressed Calling Line Identification:

- ◆ VoIP: The caller has activated the "anonymous calling" function.
- ◆ Fixed line network: The caller has activated the "anonymous calling" function or has suppressed Calling Line Identification from his fixed line network provider.

The following is displayed in place of the number:

- ◆ For calls to one of your VoIP numbers (example):

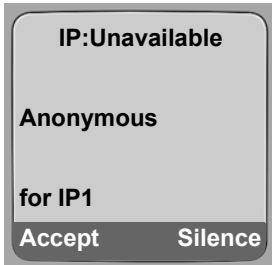

- ◆ For calls to your fixed line network numbers:
 - External, if no number is transmitted.
 - Withheld, if the caller has withheld Calling Line Identification.
 - Unavailable, if the caller has not arranged Calling Line Identification.

VoIP: Displaying the called party's phone number (COLP)

Preconditions:

- ◆ Your VoIP provider supports COLP (**C**onnect**e**d **L**ine **I**dentification **P**resentation). You may have to ask your provider to activate COLP (contact your VoIP provider for more information).
- ◆ The called party has not activated COLR (**C**onnect**e**d **L**ine **I**dentification **R**estriction).

For outgoing VoIP calls, the phone number of the connection on which the call is received is displayed on the handset.

The displayed number may differ from the number you have dialled. Examples:

- ◆ The called party has activated call forwarding.
- ◆ The call is answered by another connection within a PABX system.

If there is an entry in the directory for this phone number, the corresponding name will be displayed.

Please note:

- The number of the connection you have reached (or the assigned name) will also be displayed instead of the called number during toggling, conference calls and consultation calls.
- When the phone number is copied to the directory (**Options** → **Copy to Directory**) and the last number redial list, the dialled number (not the displayed number) is copied.

Handsfree talking

In handsfree mode, instead of holding the handset to your ear you can put it down, for example on the table in front of you. This allows others to participate in the call.

Activating/deactivating handsfree mode

Activating while dialling





Enter number and press **briefly/press and hold** the handsfree key to select the connection type (page 30).

- ▶ You should inform your caller before you use the handsfree function so that they know someone else is listening.

Switching between earpiece and handsfree mode

- ▶ Press the handsfree key  to activate/deactivate the handsfree function during a call and when listening to the answer machine (Gigaset C475 IP).

If you wish to place the handset in the charging cradle during a call:

- ▶ Press and hold the handsfree key  while placing the handset in the charging cradle.
- ▶ If the handsfree key  does not light up, press the key again.

For how to adjust the loudspeaker volume, see page 109.

Muting the handset

You can deactivate the microphone in your handset during an external call. Your caller will hear hold music, if activated (page 115).

Muting the handset



Press the control key on the left to mute the handset.

Cancelling muting



Press the display key or the end call key to cancel the muting.

Operating the handset

Activating/deactivating the handset



In idle status, press and **hold** the end call key.

You will hear the confirmation tone.

Activating/deactivating the keypad lock



Press and **hold** the hash key.

You will hear the confirmation tone. The  icon appears in the display when the keypad lock is activated.

The keypad lock deactivates automatically when you receive a call and activates again after the call.

Please note:

The handset displays an advisory message if you press a key **by accident** while the keypad lock is on. To deactivate the keypad lock, press and **hold** the hash key .

Control key

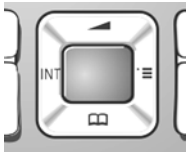

In this user guide, the side/position of the control key that you must press in the given operating situation is shown in black (top, bottom, right, left). Example:  for "press up on the control key".

The control key has a number of different functions:

When the handset is in idle status



Press and release to open the handset directory.

Press and hold to open the list of available online directories.



Open the main menu.





Open the list of handsets.







Call up the menu for setting the handset's call volume (page 109), ringer tones (page 110) and advisory tones (page 111).

In input fields



You can use the control key to move the cursor **up** , **down** , **right**  or **left** .

Display keys

In lists and menus

-  /  Scroll up/down line by line.
-  Open the submenu.
-  Go back one menu level or cancel.

During an external call

-  Press and release to open the handset directory.
Press and hold to open the Gigaset.net directory.
-  Initiate an internal consultation call.
-  Adjust the loudspeaker volume for earpiece and handsfree mode.

Display keys

The current display functions are shown in the bottom display line in reversed highlights. The function of the display keys changes depending on the particular operating situation.



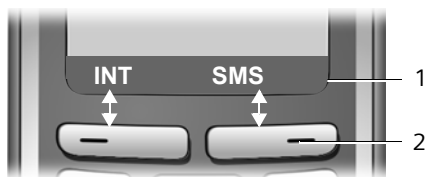



Example:



1 Current display key functions are shown in the bottom display line.

2 Display keys

The most important display icons are:

-  **Options** Open a situation-dependent menu (context menu).
-  **<C** Delete key: deletes one character at a time from right to left.
-  **↶** Go back one menu level or cancel operation.
-  **E-Mail** Fetch e-mail address from the directory.
-  **→ □** Copy number into directory.
-  **☎** Forward external call to the answer machine (Gigaset C475 IP).

Reverting to idle status

You can revert to idle status from anywhere in the menu as follows:

- ▶ Press and **hold** the end call key .

Or:

- ▶ Do not press any key: after 2 minutes the display will **automatically** revert to idle status.

Changes that you have not confirmed or saved by pressing **OK**, **Yes**, **Save**, **Send** or **Save Entry** **OK** will be lost.

You can find an example of the display in idle status on page 1.

Menu guidance



Your telephone's functions are accessed using a menu that has a number of levels.

Main menu (first menu level)

- ▶ To open the main menu, press  with the handset in idle status.

The main menu functions are shown in the display as a list with colour icons.

Accessing a function

- ▶ Navigate to the function using the control key /. The name of the function is displayed in the display header. Press the display key .

Or:



- ▶ Enter the number that is in front of the function in the menu tree (page 25) (shortcut).

The corresponding submenu (the next menu level) is opened.

Submenus

The functions in the submenus are displayed as lists.

To access a function:

- ▶ Scroll to the function with the control key  and press .

Or:

- ▶ Enter the number combination that is in front of the function in the menu tree (page 25) (shortcut).

Briefly press the end call key  once to return to the previous menu level/cancel the operation.

Correcting incorrect entries

You can correct incorrect characters in the text by navigating to the incorrect entry using the control key. You can then:

- ◆ Press  to delete the character to the left of the cursor.
- ◆ Insert a new character to the left of the cursor.
- ◆ Overwrite the flashing character when entering time and date, IP addresses etc.

You will find examples of icons used, menu entries and multiple line input in the appendix to this user guide, page 175.

VoIP telephony via Gigaset.net

You can use **Gigaset.net** to make free phone calls via the Internet **directly** to other Gigaset.net users, without having to set up an account with a VoIP provider or make any further settings. You simply have to connect your phone to the power supply and the Internet connection and, if necessary, enter yourself in the Gigaset.net online directory under a name of your choice (page 21/page 43).

Gigaset net is a VoIP service provided by Siemens Home and Office Communication Devices GmbH und Co KG, which is available to all users with a Gigaset VoIP device.

You can call other subscribers to Gigaset.net **free of charge**, i.e. there are no telephone charges other than the costs for your Internet connection. Connections to/from other networks are not possible.

Every Gigaset VoIP device is assigned a Gigaset.net phone number by default (page 171). All registered subscribers are included in the Gigaset.net directory, which you are able to access.

You can use an echo service provided by the telephone number **12341#9** (English) on the Gigaset.net Web page to test your VoIP connection.

After an announcement, the echo service sends back the voice data you have received immediately in the form of an echo.

Exclusion of liability

Gigaset.net is a voluntary service provided by Siemens Home and Office Communication GmbH & Co KG with no liability or guarantee for the availability of the network. This service can be terminated at any time with a notice period of three months.

Please note:

If you do not use your Gigaset.net connection for six weeks, it is automatically deactivated. You cannot be reached for calls from Gigaset.net.

The connection is reactivated:

- as soon as you start a search in the Gigaset.net directory or
- make a call via Gigaset.net (dial a number with #9 at the end) or
- activate the connection via the Web configurator (page 140).

Search for subscribers in the Gigaset.net directory

Your handset is in idle status.





Press and **hold**.



If necessary, select **Gigaset.net** from the list of available online directories and press **OK**.

Or:

▶ Open the directory with the  button.

▶ Select the **Gigaset.net** directory entry and press the talk key . A connection to the Gigaset.net directory is established.

Please note:

- The **Gigaset.net** directory entry is transferred to a handset when it is registered with the base station. Provided the handset can send and receive directory entries.
- Calls to the Gigaset.net directory are always **free of charge**.
- You can also open the Gigaset.net directory by dialling **1188#9** (phone number of the Gigaset.net directory) and pressing the talk key .

If no connection can be made to the Gigaset.net directory, an error message will be sent and the handset will go into idle status.

Once the connection has been established, you will be asked to enter a name that you want to search for.

Nickname search:

Enter the name or part of a name (max. 25 characters).

Options

Press the display key.

Start search

Select and press **OK**.

If the search has been successful, a hit list will be displayed of all the names that begin with the specified character string.

Example:

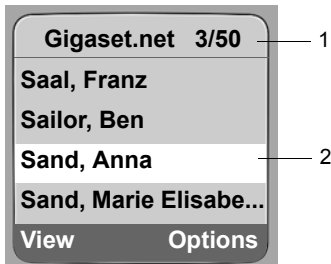

1. 3/50: Entry number/number of hits
2. Name of an entry, possibly abbreviated

You can scroll through the hit list with .

If it has **not** been possible to find a **matching** entry, a corresponding message is displayed. You have the following options:

- ▶ Press the display key **New** to start a new search.

Or

- ▶ Press the display key **Change** to change the search criteria. The previously entered name is copied and can be edited.

If there are **too many matching** entries in the Gigaset.net directory, the message **Too many entries found!** is displayed instead of a hit list.

- ▶ Press the display key **Refine** to start a refined search. The previously entered name is copied and can be edited/expanded.

Search for subscribers in the Gigaset.net directory

Calling subscribers



Select the subscriber from the hit list and press the talk key.

Viewing the subscriber's number



Select the subscriber from the hit list.

View

Press the display key.

The display shows the Gigaset.net number and the subscriber's name, whereby the name may appear over a number of lines.

Please note:

- Connections to Gigaset.net are always established via the Internet irrespective of which default connection is set on your phone. Pressing and holding or pressing it briefly and a "*" at the end of the number have no effect.
- You can open the Gigaset.net directory and establish connections, even if you have not entered yourself in the Gigaset.net directory.

Using other functions

Precondition: The hit list is displayed.



(select entry) → **Options**

The following functions can be selected with :

Add to directory

Copy the number to the handset directory. The number and name (where appropriate abbreviated, max. 16 characters) are copied to the directory.

▶ Edit and save entry where appropriate (page 50).

The hit list is displayed again.

New search

Start a search with a new name (page 41).

Own details

See "Entering, editing and deleting own entry" on page 43.

Please note:

If you select a Gigaset.net number from the local directory, the connection is automatically established via the Gigaset.net (Internet).

Entering, editing and deleting own entry

You have the following options:

- ◆ Edit the name of your entry in the Gigaset.net directory
- ◆ Delete your entry from the Gigaset.net directory
- ◆ If you did not enter a name when using the phone for the first time (page 21), specify a name and enter yourself in the directory.

Viewing own entry

You are connected to the Gigaset.net directory:

- ▶ Select **Options** → **Own details** and press **OK**.

Your Gigaset.net number and, where applicable, your currently entered name are displayed.

Entering/editing a name

Edit Press the display key.



Edit name or enter new name (max. 25 characters) and press **OK**.

You can delete the name with **<C>**.

If there is not yet an entry with this name in the Gigaset.net directory, the name is saved. A message to this effect is displayed. The handset switches to idle status.

If there is already an entry with this name, or the entered name contains impermissible characters, you will be requested to enter a different name.

Please note:

If you delete the name, your entry will be deleted from the directory. You are no longer "visible" to other Gigaset.net subscribers. However, you can still be reached via your Gigaset.net number. For information on how to display the number, see page 171.

Calling a Gigaset.net subscriber

You can call a Gigaset.net subscriber directly via the Gigaset.net directory (see above) or via their Gigaset.net number:



Enter the Gigaset.net number (including the #9) or select from the handset directory.



Press the talk key.

Every number ending with #9 is dialled via Gigaset.net.

Network services

Network services are functions made available by your fixed line network or VoIP provider.

Anonymous calling – withholding caller ID

Phone number identification can be withheld (CLIR = Calling Line Identification Restriction). Your number will not be displayed when making outgoing calls. You are calling anonymously.

Preconditions:

- ◆ For unknown calls via your fixed line network connection you need to have requested the relevant service (feature) from your fixed line network provider.
- ◆ Anonymous calls are only possible via VoIP connections through providers that support the "anonymous calling" function. You may have to ask your VoIP provider to activate this function.

Activating/deactivating anonymous calling for all calls

Withholding caller ID can be activated/deactivated permanently for all your phone's connections (fixed line network and VoIP).

When this function is activated, the phone number will be withheld both for fixed line network calls and for calls via a VoIP connection. Withholding caller ID is activated for all registered handsets.

 →  Sel. Services

Always anon.

Select and press **OK** ( = on).

If the **Always anon.** function is activated, **Withhold number active** is shown in the handset's idle display.

Activating/deactivating "anonymous calling" for the next call

You can change the setting for withholding caller ID for the next call.

 →  Sel. Services → Next Call

Anonymous:

Select **Yes / No** to activate/deactivate withholding caller ID and press **Dial**.



If necessary, enter the phone number with line suffix.

Send

Press the display key. The phone number is dialed. If you have not specified a line suffix, the number will be dialed via the default connection.

Further network services for fixed line networks

The following network services can only be used for making calls via the fixed line network. You will need to request them from your fixed line network provider.

- ▶ If you require assistance, please contact your network provider.

Settings for all calls

If you have completed one of the following procedures, a code is sent.

- ▶ After confirmation from the telephone network, press the end call key .

You can set the following features:

General call forwarding

 →  Sel. Services → Fixed Line → Call Divert

- ▶ Change multiple line input:

When:

Select All Calls / No Answer / When Busy.

Call No.:

Press the display key **Edit**. Enter the number to which the call is to be forwarded, and press **Save**. You can enter a fixed line, VoIP or mobile number.

Status:

Activate/deactivate call forwarding.



- ▶ Press the display key **Send**.
- ▶ Press the end call key  after the announcement from the telephone network.

Activating/deactivating call waiting

If call waiting is activated, a caller on the fixed line network will hear the ringing tone if you are already conducting a phone conversation using your fixed line connection. This call is announced acoustically and visually on your handset screen.

Calls on the VoIP connection are not shown as call waiting. They are signalled on other registered handsets. If no other handset is available, the caller will hear the busy tone.

Accepting/rejecting a waiting call, see page 46.

 →  Sel. Services → Fixed Line → Call Waiting

Status: Activate/deactivate.

- ▶ Press the display key **Send**.
- ▶ Press the end call key  after the announcement from the telephone network.

Please note:

The setting does not affect the procedure for call waiting on the VoIP connection. For how to activate/deactivate call waiting for the VoIP connection, see page 47.

Functions during a call

Initiating ringback

You hear the busy tone.

Options → Ringback



Press the end call key.

Consultation call

During a call:

Ext.Call Press the display key.



Enter a number or copy it from the directory and press **OK**.

The number will be dialled via the fixed line connection.

Please note:

After a few seconds, the number selected for a consultation call is saved in the last number redial list.

You have the following options:

◆ Toggling:

- ▶ Use to toggle between the participants.
- End call with active participant: **Options End Active Call**.
- End call with both participants: press the end call key .

Accepting a waiting call

Precondition: Call waiting is activated (page 45).

Accept Press the display key.

Or: if the caller's number is not transferred:

Options → Accept waiting call

You have the option of toggling or holding a conference call.

Please note:

- Without CLIP, a waiting call is only announced with a signal tone.
- If the first call was an internal call, the internal connection is ended.
- An internal call waiting is shown on the display. You can neither accept the internal call nor reject it.

Functions after a call

Cancelling ringback



→ Sel. Services → Ringback Off

If you have cancelled the ringback, a code is sent.

- ▶ After confirmation from the telephone network, press the end call key .

Further network services for VoIP

You can use the following network services to make calls via the VoIP connection.

Settings for all calls

General call forwarding

Precondition: The VoIP provider supports call forwarding.

 →  Sel. Services → VoIP → Call Divert

The display shows a list of configured and activated VoIP phone numbers and the Gigaset.net number of your telephone. Numbers for which call forwarding is activated are marked with .

- ▶ Select the phone number for which you want to activate or deactivate call forwarding, and press **OK**.
- ▶ Change multiple line input:

When:

Select **All Calls / No Answer / When Busy**.

Call No.:

Press the display key **Edit**. Enter the number to which the call is to be forwarded, and press **Save**.

You can state a fixed line network, VoIP or mobile number for forwarding calls from a VoIP number.

You must state another Gigaset.net number for call forwarding from your Gigaset.net number.

Status:

Activate/deactivate call forwarding.

- ▶ Press the display key **Save**.

Please note that call forwarding from your VoIP number may incur additional costs. Please consult your VoIP provider.

Activating/deactivating call waiting

Precondition: Your phone will permit two parallel VoIP connections (s. **Allow 1 VoIP call only** on page 141).

If call waiting is activated, a caller on one of your VoIP connections will hear the ringer tone if you are already on a call using this VoIP connection. This call is announced acoustically and visually on your handset screen.

Calls on the fixed line connection are not signalled as call waiting. They are signalled on other registered handsets to which the fixed line number has been allocated as a receive number. If no other handset is available, the caller will hear the busy tone.

Accepting/rejecting a waiting call, see page 48.

 →  Sel. Services → VoIP → Call Waiting

Status: Activate/deactivate.

- ▶ Press the display key **Save**.

Please note:

The setting applies to all VoIP phone numbers. It does not affect the procedure for call waiting on the fixed line connection. For how to activate/deactivate call waiting for the fixed line connection, see page 45.

Functions during a call

Precondition: Your phone will permit two parallel VoIP connections (s. **Allow 1 VoIP call only** on page 141).

Consultation call

During a call:

Ext.Call Press the display key.





Enter the number or copy from the directory and **press and release/press and hold** .

The number must be dialled via VoIP.

Please note:

After a few seconds, the number selected for a consultation call is saved in the last number redial list.

If the participant answers, you have the following options:

- ◆ **Toggling:**
 - ▶ Use  to toggle between the participants.
 - ▶ End call with active participant: **Options End Active Call**.
- ◆ **Conference call:**
 - ▶ Call both participants: press the display key **Conf.**
 - ▶ End the conference call (toggling): press display key **EndConf**.
 - ▶ End call with both participants: press the end call key .
- ◆ **Forwarding (provider dependent):**

Precondition: You are toggling calls and you phoned the currently active participant yourself.

- ▶ To connect the two external participants: **Options Call Transfer**

If call forwarding was successful, a message will appear to this effect. The handset will then switch to idle.

Accepting a waiting call

Precondition: Call waiting is activated (page 47).

Accept Press the display key.

You have the option of toggling or holding a conference call.

Please note:

- If the first call was an internal call, the internal connection is ended.
- An internal call waiting is shown on the display. You can neither accept the internal call nor reject it.

Using the directory and lists

The options are:

- ◆ Directory
- ◆ Call-by-call list
- ◆ If applicable, online directories
- ◆ Last number redial list
- ◆ E-mail, SMS and messenger list
- ◆ Calls list
- ◆ Answer machine list (for Gigaset C475 IP)

You can store a maximum of 250 entries in the directory and call-by-call list (the actual number depends on the size of the individual entries).

You create the directory and call-by-call list for your own individual handset. However, you can send the lists or individual entries to other handsets (page 52).

Directory/call-by-call list

Please note:

For quick access to a number from the directory or the call-by-call list (quick dial), you can assign the number to a key (page 52).

Directory

In the **directory** you can store numbers and corresponding names.

- ▶ With the handset in idle status, open the directory by pressing the  key.

Length of entries

Number: max. 32 digits

Name: max. 16 characters

Please note:

Some VoIP providers do not support local calls for calls to the fixed line network. In this case, always enter the fixed line number with the area code in your directory. Alternatively, you can also use the Web configurator to define an area code, which is automatically prefixed to all numbers that are dialled via VoIP without an area code (page 148).

Call-by-call list

The **call-by-call list** is used to store access codes for network providers (called "call-by-call numbers"), that can be put ahead of the numbers when dialling via the fixed line network.

- ▶ Open the call-by-call list in idle status by pressing the  key.

Length of entries

Number: max. 32 digits

Name: max. 16 characters

Storing a number in the directory

 → New Entry

▶ Change multiple line input:

Number

Enter the number.

Name

Enter name.

Quick Dial:

Select number key for quick dial.

▶ Save the changes.

Please note:

- To find out how to enter IP addresses, turn to page 32.
- If you want to dial a certain number using the same line connection each time, you can add the relevant line suffix to the number in question (page 31).
- If you add a star (*) at the end of the number, the number will be dialled via the non-standard connection (page 116), even if you press and release the  talk key. On condition that no dialing plan has been defined for the number (page 149).
- You can use the Web configurator to save the directory to a file on your PC, where it can be edited and then sent back to the handset (page 157). Or you can transfer Outlook contacts from the PC to the handset's directory.

Storing a number in the call-by-call list

 → New Entry

▶ Change multiple line input:

Number:

Enter the number.

Name:

Enter name.

Order of directory entries

The directory entries are usually sorted in alphabetical order. Spaces and digits take first priority. The sort order is as follows:



1. Space
2. Digits (0–9)
3. Letters (alphabetical)
4. Other characters

To get round the alphabetical order of the entries, insert a space or a digit in front of the name. These entries will then move to the beginning of the directory. Names that you have prefixed with a star will move to the end of the directory.

Selecting entries in the directory and call-by-call list

 /  Open the directory or call-by-call list.

You have the following options:

- ◆ Use  to scroll to the entry until the required name is selected.
- ◆ Enter the first character of the name, or scroll to the entry using  if required.

Dialling with the directory/call-by-call list

 /  →  (Select entry; page 51)

 Briefly press/press and hold the talk key. The number is dialled using the selected connection type (page 30).

Please note:

You can only dial IP addresses via VoIP.

Managing directory/call-by-call list entries

 /  →  (Select entry; page 51)

Viewing entries

View Press the display key. The entry is displayed.
Back with **OK**.

Editing entries

View **Edit** Press the display keys one after the other.
▶ Carry out changes and save.



Using other functions

 /  →  (Select entry; page 51)

Options Open menu.

The following functions can be selected with :

Display Number

Change or add to a saved number and then dial it (press talk key ) or save it as a new entry; to do so, press  after the number is displayed.

Edit Entry

Edit selected entry.

Delete Entry

Delete selected entry.

VIP Entry (directory only)

Mark a directory entry as a **VIP** (Very Important Person) and assign a specific ringer tone to it. You can then recognise VIP calls from the ringer tone.

Precondition: Calling Line Identification (page 33).

Copy Entry

Send a single entry to a handset (page 52).

Directory/call-by-call list

Delete List

Delete **all** entries in the directory or in the call-by-call list.

Copy List

Send complete list to a handset (page 52).

Available Memory

Display the available entries in the directory and call-by-call list.

Using quick dial keys

How to assign phone numbers to the keypad on your handset is described on page 50.

► Press and **hold** the required quick dial key.

If there is a valid line suffix at the end of the number in the directory (e.g.: #1), the number will be dialled via the line belonging to the suffix (page 133).

A number with a hash key (#) only at the end will be dialled via the default connection.



A number with a star (*) at the end will be dialled via the non-default connection (page 116).

If no suffix is entered, the number will be dialled via the default connection. Exception: A dialling plan has been defined for the number (page 149).

Sending the directory/call-by-call list to another handset

Preconditions:

- ◆ The sending and receiving handsets must both be registered to the same base station.
- ◆ The other handset can send and receive directory entries.

 /  →  (Select entry; page 51) → **Options** → **Copy Entry / Copy List**

 Select the internal number of the receiving handset and press **OK**.

A successful transfer is confirmed by a message and confirmation tone on the receiving handset.

You can transfer several individual entries one after the other by responding **Yes** to the **Copy next entry?** prompt.

Please note:

- ◆ Entries with identical numbers are not overwritten in the receiver handset.
- ◆ The transfer is cancelled if the phone rings or if the memory of the receiving handset is full.

Copying a displayed number to the directory

You can copy numbers to the directory that are displayed in a list, e.g. the calls list or the last number redial list, in an SMS or during a call.

A number is displayed:

 → **Copy to Directory**

Or:



 Press the display key.

- ▶ Complete entry, see page 50.

Gigaset C475 IP: The message playback is interrupted during the number transfer from the answer machine list.

Copying a number from the directory

In many operating situations you can open the directory to copy a number, for example. Your handset need not be in idle status.

- ▶ Depending on the operating situation, open the directory with  or  or **Options Directory**.

 Select an entry (page 51).

Using online directories

You can use online directories (= online directories and classified directories, e.g. "Yellow Pages") depending on your provider.

You can define which online directories you wish to use via the Web configurator (page 155).

Exclusion of liability

Siemens Home and Office Communication GmbH & Co KG assumes no guarantee or liability for the availability of this service. The service may be discontinued at any time.

Opening an online directory/classified directory



Precondition: The handset is idle and a VoIP connection is available.

 Press and **hold**. This opens the list of online directories. Provider-specific names appear in the display.

 Select directory (online directory or classified directory) from the list and press **OK**.

Or:

You can find the **Net Directory**, **Yellow Pages** entries for online directories in the local directories of a registered handset. You can use these entries to access the online directories assigned to your handset (page 155).

- ▶ Open the directory with the  button.
- ▶ Select the **Net Directory** entry for the online directory or the **Yellow Pages** entry for the classified directory and press the talk key .

Using online directories

This establishes a connection to the online directory or the classified directory.

Please note:

- The directory entries **Net Directory / Yellow Pages** are transferred to the handset when it is registered with the base station (page 98). Precondition: The handset can send and receive directory entries.
 - You can also establish a connection to the online directory as follows:
 - ▶ When the handset is idle, dial 1#91 and then press the talk key .
 - ▶ To establish a connection to the classified directory, dial 2#91.
 - ▶ To establish a connection to the Gigaset.net directory, dial 1188#9.
- Calls to the online directory are always free of charge.

Searching for an entry

Precondition: You have opened the online telephone/classified directory.

- ▶ Making a multi-line entry:

Surname: (Online directory) /

Category/Name: (Classified directory)

Enter the name, part of a name or the trade sector (max. 30 characters).

City: Enter the name of the town in which the subscriber you are searching for lives.

Number: Enter the number (max. 30 characters).

- ▶ Press the display key **Search** to start the search.

You must make an entry in either **Surname:** or **Category/Name:** **and** in **City:** or in **Number.** Searching by number is only possible if supported by the online directory you have selected. Entering text see page 177.

A list of found towns will be displayed if the search returns more than one result:



Select the town.

Use **View** to display detailed information on the selected town.

If no matching town is found: press **Edit** if you want to change the search criteria. The entries for **Category/Name** and **City** are adopted and can be changed.

OK

Press the display key to continue the search.

A corresponding message will appear on the display if no subscriber is found to match the search criteria. You have the following options:

- ▶ Press the display key **New** to start a new search.

Or

- ▶ Press the display key **Edit** to change the search criteria. The stated name and town are adopted and can be changed.

No hits will be displayed if the list of hits is too large. A message to this effect is displayed.

- ▶ Press the display key **Refine** to start a refined search (page 55).

Or

- ▶ Provider-dependent: You can view the list if the number of hits is shown on the display. Press the display key **View**.



Search result (hit list)

The search result is shown as a list on the display. Example:



1. 3/50: Consecutive number/total number of hits (only the consecutive number is displayed if the total number of hits >99)
2. Four lines with subscriber's name, trade sector, telephone number and address (possibly abridged)

You have the following options:

- ▶ You can scroll through the hit list with .
- ▶ Press the display key **View**. Displays the unabridged details of the entry (name, trade sector where applicable, address, telephone numbers). You can scroll through the hit list with .

You have the following additional options via **Options**:

Refine search

Refine search criteria and restrict list (page 55).

New search Start a new search.

Copy to Directory

Transfer the entry number to the handset's directory (page 53). The surname is transferred to the name field of the directory.



Calling subscribers

Precondition: A hit list is displayed.

- ▶ Select the entry and press the talk key .

This dials the number in the display if there is only one number.

A list of numbers appears if there is more than one number.

- ▶ Select the number with  and press the talk key  once again.

Start detailed search

You can use the search options available in the detailed search (first name and/or street) to limit the number of hits returned by a previous search.

Precondition: A search result is displayed (hit list with multiple entries or a message indicating too many hits).

Refine Press the display key.

Last number redial list

Or

Options → Refine search

Select and press **OK**.

The search criteria from the previous search are adopted and entered in the corresponding fields.

Surname: (Online directory) /

Category/Name: (Classified directory)

If necessary, change name/trade sector or extend partial name.

City: If necessary, change the name of the town.

Street: If necessary, change the name of the street (max. 30 chars.).

First name: (only in the online directory)

If necessary, enter the first name (max. 30 characters).

Search Start detailed search.

Last number redial list

The last number redial list contains the 20 numbers last dialled with the handset (max. 32 digits). If a number is in the directory or the call-by-call list, then the appropriate name will be displayed.

Dialling from the last number redial list



Press the key **briefly**.



Select an entry.



Briefly press/press and hold the talk key. The number is dialled using the selected connection type (page 30).

When a name is displayed, you can display the corresponding phone number by pressing the display key **View**.

Managing entries in the last number redial list



Press the key **briefly**.



Select an entry.

Options Open menu.

The following functions can be selected with :

Display Number

(as in the directory, page 51)

Copy to Directory

Copying a displayed number to the directory (page 53).

Delete Entry

Delete selected entry.

Delete List



Delete complete list.

Opening lists with the message key

You can use the message key  to open the following lists:

- ◆ Answer machine list (Gigaset C475 IP only)
- ◆ Network mailbox, see page 96
A separate list is displayed for each network mailbox.
Precondition: Its number is saved in the base station, it is switched on (page 94/ page 151) and the corresponding VoIP/fixed line network number is assigned to the handset as a receive number
- ◆ SMS list, see page 64
If **several** mailboxes are set up (page 67), several lists will be displayed, if required.
- ◆ Incoming e-mail list, see page 81
The list is only shown if new messages have arrived in the mailbox from the incoming e-mail server.
- ◆ Calls list
- ◆ Messenger message list, see page 89
The list is only shown on the handset that is online.

An advisory tone sounds as soon as a **new message** arrives in a list. The  key flashes (it goes off when the key is pressed). In idle status, the display shows an icon for the new message:

Icon	New message...
	... in answer machine list (Gigaset C475 IP) or to one of your network mailboxes
	... in calls list
	... in the SMS, messenger or e-mail list

The number of new entries is shown beneath the corresponding icon.

List selection

Pressing the  button will only display lists that contain messages and also the network mailbox lists **Net AM:**

Lists with new messages are shown first and identified in bold. The number of messages received are shown in brackets.

If a list contains no new messages, the number of old messages will be shown. Exception: (0) is displayed for **Net AM:** ... network mailboxes.

Example:

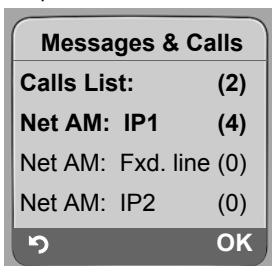



Opening lists with the message key

- ▶ Select a list with  and press **OK**.

Calls list

Precondition: Calling Line Identification (CLIP, page 33).

Depending on the type of list set, the calls list contains

- ◆ missed calls
- ◆ received calls (marked with )
- ◆ on the Gigaset C475 IP:
 - calls received by the integrated answer machine (marked with )

The numbers of the last 30 calls are saved.

Multiple calls from the same number will be stored once in the list of missed calls (the latest call). The number of calls from this number is shown in brackets after the entry.

Multiple calls from the same number are stored several times in the list of answered calls.

Please note:

Only calls to the receive numbers assigned to your handset are stored in the calls list (page 144). If no receive numbers are assigned, all calls will be stored in the calls list for all handsets.

Setting the calls list type

 →  **Settings** → **Base** → **Calls List Type**

Missed Calls / All Calls

Select and press **OK** ( = on).



Press and **hold** (idle status).

The calls list entries are retained when you change the list type.

Entries in the calls list

New messages are displayed at the top.

Example of list entries:



- ◆ List type in header: **Missed Calls, All Calls**
- ◆ Status of entry
 - Bold:** new entry
- ◆ Number or name of caller
 - You can add the caller's number to the directory (page 53).

- ◆ Date and time of call (if set, page 13)
- ◆ Type of entry:
 - accepted calls ()
 - missed calls
 - calls recorded by the answer machine (∞, Gigaset C475 IP only)

Managing entries in the calls list

Pressing the display key **Delete** deletes the marked entry.

After pressing the display key **Options** you can select more functions with :

Copy to Directory

Copying a displayed number to the directory.

Information

If a URI was received and stored for a VoIP call, this will be shown. The URI is dialed if you press the talk key . The URI is not entered on the last number redial list.

Delete List

Delete complete list.

When you quit the call history, all entries are set to the status "old", i.e. the next time you call the list up they will no longer be shown in bold.

Answer machine list (Gigaset C475 IP)

The answer machine list **Ans M.:** is only displayed on handsets that have at least one receive number in common with the answer machine.

You can use the mailbox list to listen to the messages that are in the mailboxes.

The first new message received is displayed in the answer machine list. Playback starts when the list is opened.

New messages are placed after old messages when they have been played back.

All messages are played back irrespective of the associated receive number.

Old messages are played back if the list does not contain any new messages.

How to manage messages in the answer machine list is described on page 74.

Select from caller list/answer machine list

 → **Calls List: (2) / Ans M.: (1)**

 Select entry.

 Briefly press/press and hold the talk key. The number is dialed using the selected connection type (page 30).

Making cost-effective calls

Using the Internet (VoIP) is the preferred cost-effective way of making calls.

You can also use your phone's cost control function for calls to fixed line or mobile phone networks. Open accounts with various VoIP providers who offer favourable rates for calls to other networks. In the phone configuration, define the best VoIP connections (account), e.g. for specific regional, national and mobile network prefixes, to be used when calls are made (**Dialling Plans**, page 149). Or define the VoIP connection to be used when dialling the number (dialling with line suffix, page 31).

If you are using your fixed line network to make a call, choose a network provider that offers particularly favourable rates (call-by-call). You can manage call-by-call numbers in the call-by-call list

Linking call-by-call numbers with a number

You can prefix a network provider's number ("chaining") to numbers dialled via a fixed line network



Open call-by-call list.



Select entry (call-by-call number).

Options

Press the display key.

Display Number

Select and press **OK**.



Enter number or dial number from the directory (page 53).



Briefly press/press and hold the talk key so that the number is dialled via the fixed line network. Both numbers are dialled.

Please note:

You can define appropriate rules for Call-by-Call numbers (page 149) to enable the linked number to be dialled via the fixed line network. Or you can attach the line suffix #0 (for the fixed line network) to the numbers.

Displaying the call duration

The duration of each call appears in the display for calls made via a fixed line network and VoIP

- ◆ during the conversation,
- ◆ until about three seconds after the call has ended if you do not replace the handset in the charging cradle.

Please note:

The actual duration of the call can vary from that shown by a few seconds.

SMS (text messages)

You can only send and receive SMS messages via the fixed line network.

When an SMS is sent, the base station automatically establishes a connection via the fixed line network.

Your phone is supplied ready for sending SMS messages immediately.

Preconditions:

- ◆ Calling Line Identification is enabled for your fixed line network connection.
- ◆ Your network provider supports SMS in the fixed line network (information on this can be obtained from your network provider).
- ◆ You are registered with your service provider to send and receive SMS.

SMS messages are exchanged between SMS centres operated by service providers. You must enter the SMS centre through which you wish to send and receive SMS messages into your phone. You can receive SMS messages from **every** SMS centre that is entered, provided you have registered with your service provider.

Your SMS messages are sent via the **Service Centr.** that is entered as the **active send service centre**. However, you can activate any other SMS centre as the active send service centre to send a current message (page 68).

If no SMS service centre is entered, the SMS menu only contains the entry **Settings**. Enter an SMS service centre (page 68).

Information on writing an SMS can be found in the appendix (page 177).

Rules

- ◆ An SMS can be up to 612 characters.
- ◆ For more than 160 characters, the SMS will be sent as a **linked** SMS (up to four SMS messages each containing 152 or 153 characters, depending on the length of the linking information).

The following will be shown on the top right in the header when an SMS is being written (example):

SMS 596(1)

1 Maximum number of characters you can still write or attach.



2 Number of SMS messages that need to be linked for the text written so far.

Please note that linking SMS messages usually incurs higher charges.

Please note:



- ◆ If your phone is connected to a PABX, see page 69.
- ◆ To receive SMS messages you must be registered with your service provider.

Registering with the registration assistant

The first time you open the  →  **Messaging** → **SMS** menu, you will be asked whether you wish to be registered automatically with all entered SMS centres (see page 68). If you confirm with **Yes**, you will be able to receive SMS messages from all registered SMS centres.

If you answer with **No**, automatic registration will be cancelled. You can start automatic registration at a later time via the menu:

Precondition: SMS centres have been entered.

 →  **Messaging** → **SMS** → **Settings** → **Subscribe to SMS**

The registration assistant does not support setting up personal mailboxes (page 67).

Writing/sending an SMS

Writing an SMS

 →  **Messaging** → **SMS**

Mailbox 2 Select mailbox if necessary and press **OK** (page 67).

 Enter mailbox PIN if necessary and press **OK**.

New SMS Select and press **OK**.

 Write an SMS.

Sending an SMS

 Press the talk key



or:

Options Press the display key.

Send Select and press **OK**.

Then:

SMS Select and press **OK**.

 /  / 
Select number with area code (even if you are in that area) from the directory or call-by-call list, or enter number directly. For sending SMS to an SMS mailbox: add the mailbox ID to the **end** of the number.

Send Press the display key.

The SMS will be sent as soon as your phone's fixed line connection is free.

Please note:

- If you are interrupted by an external call while writing an SMS, the text is automatically saved in the draft message list.
- If the memory is full, or if the SMS function on the base station is being used by another handset, the operation is cancelled. An appropriate message appears in the display. Delete SMS messages you no longer require or send the SMS later.

Draft message list

You can save an SMS in the draft message list and edit and send it later.

Saving an SMS in the draft message list

► Write an SMS (page 62).

Options Press the display key.

Save Select and press **OK**.

Please note:

After saving, the SMS editor with your SMS will be displayed again. You can continue writing the text and save it again. The SMS that was saved previously will be overwritten.

Opening the draft message list

 →  **Messaging** → **SMS** → (mailbox, mailbox PIN)

Outgoing (3)

Select and press **OK**. The number of SMS messages in the list will be shown in brackets (e.g. (3)).

The first list entry is displayed, e.g.

1234567890
15.01.08 12:20

Reading or deleting SMS messages

► Open the draft message list and then:

 Select SMS.

Read Press the display key. The entry will be displayed. Scroll line by line using .

Or:

Options Open menu.

Delete Entry Press **OK**. The selected SMS message is deleted.

You can use **Options** → **Delete all** to delete every SMS in the draft message list.

Writing/changing an SMS

► You are reading an SMS in the draft message list.

Options Open menu.

You have the following options:

New SMS

Write a new SMS and then send (page 62) or save it.

Edit

Edit the text of the saved SMS and then send it (page 62).

Character Set

Text is shown in the selected character set.

Receiving an SMS

All received SMS messages are saved in the incoming message list. Linked SMS messages are displayed as **one** message. If this is too long (it consists of too many linked individual SMS messages) or if it was not fully transmitted, it will be split into several individual SMS messages.

Since an SMS remains in the list even after it has been read, you should **regularly delete SMS messages from the list**.



The display tells you if the SMS memory is full.

- ▶ Delete SMS messages you no longer require (page 64).

Incoming message list

The incoming message list contains:

- ◆ All received SMS messages, starting with the most recent.
- ◆ SMS messages that could not be sent due to an error.

New SMS messages are signalled on all Gigaset C47H handsets by the  icon in the display, the flashing message key  and an advisory tone.

Opening the incoming message list with the key

 Press.

Select a mailbox if necessary and enter mailbox PIN.

The incoming message list is displayed as follows (example):

SMS:	(2)	1
		2

- 1 **Bold:** number of new entries
Regular: number of read entries
- 2 Name of mailbox, here: general mailbox

Open list with **OK**.

An entry in the list is displayed as in the following example:

1234567890		1
01.01.08	09:45	2

- 1 Number of the sender or name of the directory entry
- 2 **SMS status:**
Bold: new unread SMS messages
Regular: old read SMS messages

Opening the incoming message list via the SMS menu

 →  Messaging → **SMS** → (mailbox, mailbox PIN) → Incoming (2)

Reading or deleting SMS messages

- ▶ Open the incoming message list.
- ▶ Continue as described in "Reading or deleting SMS messages", page 63.

After you have read a new SMS, it is given the status "Old" (it is no longer shown in bold).

Deleting the incoming message list

All **new and old** SMS messages in the list are deleted.

- ▶ Open the incoming message list.

Options Open menu.

Delete all Select, press **OK** and confirm with **Yes**. The list is cleared.

Replying to or forwarding SMS messages

- ▶ Read the SMS (page 64):

Options Press the display key.

You have the following options:

Reply

Write and send a reply SMS directly (page 62).

Edit

Edit the text in the SMS and then send it (page 62).

Forwarding an SMS

- ▶ You are reading an SMS (page 64):

Options Press the display key.

Forward Select and press **OK**. For further information, see page 62.

Copying the number to the directory

Copying the sender's number

- ▶ Open the incoming message list and select entry (page 64).

Options Press the display key. For further information, see page 53.

Please note:

- You can create a special directory for SMS messages within your main directory by putting a star (*) before the names.
- An attached mailbox identifier is added to the directory. It must be deleted for 'normal calls'.

Dialling numbers from SMS texts/transferring to the directory

- ▶ Read the SMS (page 64) and scroll to the telephone number.

The digits are reverse-highlighted.



Briefly press/press and **hold** the talk key to dial the number.

Or:



Press the display key to transfer the number to the directory. For further information, see page 53.

Notification by SMS

Please note:

- The + symbol is not transferred for international area codes.
 - ▶ You should then enter '00' at the start of the number.
- If an SMS contains several numbers, the next number will be highlighted if you scroll down until the first number disappears from the display.

If you wish to use the number to send an SMS:

- ▶ Save the number with the local area code (dialling code) in the directory.

Notification by SMS

You can be notified about missed calls or new answer machine messages (with the Gigaset C475 IP) via SMS.



Precondition: For missed calls, the caller's number (CLI) must have been transmitted.

Notification is sent to your mobile phone or another phone with SMS functionality.

You only need to set the phone number to which notification should be sent (notification number) and the notification type.

Please note that your network provider will usually charge for SMS notifications.

Saving the notification number

 →  **Messaging** → **SMS** → **Settings** → **Notify Number**

 Enter the number (including area code) to which the SMS is to be sent.

 **Save** Press the display key.

 Press and **hold** (idle status).

Warning:

Do **not** enter your own fixed line number for the notification of missed calls. This can lead to chargeable endless looping.

Setting the notification type

 →  **Messaging** → **SMS** → **Settings** → **Notify Type**

- ▶ Change multiple line input if necessary:

Missed Calls:

Select **On** if you require SMS notification.

Ans Machine: (Gigaset C475 IP)

Select **On** if you require SMS notification.

- ▶ Save changes (page 177).

SMS mailboxes



The **general mailbox** is the default setting. Anyone can access this mailbox and it cannot be protected by a PIN. You can additionally set up three **personal mailboxes** and protect these with a **PIN**. Each mailbox is identified by a name and a "mailbox ID" (a kind of extension number).

Please note:

- ◆ If you operate a number of devices (base stations) with SMS functionality on a single phone line, then each SMS mailbox ID may only occur once. In this case you must also change the preset ID of the general mailbox ("0").
- ◆ You can only use personal mailboxes if your service provider supports this function. You can tell whether this is the case by the addition of a star (*) to the number of a (preset) SMS centre.
- ◆ If you have forgotten your mailbox PIN, you can reset it by restoring the base station's default settings. This will **delete all SMS messages from all mailboxes**.

Setting up and changing a personal mailbox

Setting up a personal mailbox

 →  Messaging → SMS → Settings → SMS Mailboxes

 Select mailbox, e.g. **Mailbox 2**, and press **OK**.

▶ Change multiple line input:

On/Off:

Activate or deactivate mailbox.

ID:

Select mailbox ID (0–9). You can only select the available numbers.

Protection:

Activate/deactivate PIN protection.

PIN:

If necessary, enter 4-digit PIN.

▶ Save changes (page 177).

Active mailboxes are marked with in the mailbox list. They are shown in the SMS list and can, if necessary, be displayed by pressing the message key .

Deactivating a mailbox

▶ Set **On/Off:** to **Off**. Confirm message with **Yes** if necessary.

All SMS messages saved in this mailbox will be deleted.



Deactivating PIN protection

▶ Set **Protection:** to **Off**.

The mailbox PIN is reset to "0000".

Setting SMS centres

Changing the name of a mailbox

 →  **Messaging** → **SMS** → **Settings** → **SMS Mailboxes** →  (Select mailbox)



 Press the display key.

 Enter new name.

 Press the display key.

 Press and **hold** (idle status).

Changing a mailbox's PIN and ID

 →  **Messaging** → **SMS** → **Settings** → **SMS Mailboxes** →  (Select mailbox)

 Enter mailbox PIN if required and press **OK**.

▶ Set ID:, **Protection:** and **PIN** (page 67).

Sending an SMS to a personal mailbox

To send an SMS to a personal mailbox, the sender must know your ID and enter it after your number.



▶ You can send your SMS contact an SMS via your personal mailbox.

Your SMS contact will then receive your SMS number with current ID and can save it in their directory. If the ID is invalid, the SMS will not be delivered.

Setting SMS centres

Entering/changing SMS centres

▶ You should find out about the services and special functions offered by your service provider **before you make a new application** and/or before you delete pre-configured call numbers.

 →  **Messaging** → **SMS** → **Settings** → **Service Centres**

 Select SMS centre (e.g. **Service Centr. 1**) and press **OK**.

▶ Change multiple line input:

Active Send:

Select **Yes** if SMS messages are to be sent via the SMS centre. For the SMS centres 2 to 4, the setting only applies to the next SMS.

SMS:

Press the display key **Edit**. Enter the number of the SMS service and insert a star if your service provider supports personal mailboxes.

▶ Save changes (page 177).

Please note:

Ask your service provider for details on how to enter service numbers if you wish to use personal mailboxes (precondition: your service provider supports this function).

Sending an SMS through another SMS centre

- ▶ Activate the SMS centre (2 to 4) as the **active send service centre**.
- ▶ Send the SMS.

This setting only applies to the next SMS to be sent. Thereafter, the setting returns to **Service Centr. 1**.

SMS on a PABX

- ◆ You can only receive an SMS when the **Calling Line Identification is forwarded** to the extension of the PABX (**CLIP**). The CLIP evaluation of the phone number for the SMS centre takes place in your **Gigaset**.
- ◆ If required, you must prefix the number for the SMS centre with the access code (depending on your PABX).
 If in doubt, test your PABX, e.g. by sending an SMS to your own number: once with and once without the access code.
- ◆ When you send SMS messages, your sender number may be sent without your extension number. In this case the recipient cannot reply to you directly.

Sending and receiving SMS messages **on ISDN PABXs** is only possible via the MSN number assigned to your base station.

Activating/deactivating SMS function

If you deactivate the SMS function, you cannot send or receive any SMS messages with your phone.

The settings you have made for sending and receiving SMS messages (e.g. the call numbers of the SMS centres) and the entries in the incoming and draft message lists are saved even after you turn off your phone.

 Open menu.

Enter the digits.

 Deactivate SMS function.

Or:

 Activate SMS function (default setting).

SMS troubleshooting

Error codes when sending

EO	Calling Line Identification permanently withheld (CLIR) or Calling Line Identification not activated.
FE	Error occurred during SMS transfer.
FD	Connection to SMS centre failed; see self-help.

Self-help with errors

The following table lists error situations and possible causes and provides notes on troubleshooting.

<p>You cannot send messages.</p> <ol style="list-style-type: none"> 1. You have not requested the CLIP service (Calling Line Identification Presentation). <ul style="list-style-type: none"> ▶ Ask your service provider to enable this service. 2. SMS transmission has been interrupted (e.g. by a call). <ul style="list-style-type: none"> ▶ Re-send the SMS. 3. Network provider does not support this feature. 4. No number or an invalid number is entered for the SMS centre set as the active send service centre. <ul style="list-style-type: none"> ▶ Enter the number (page 68).
<p>You receive an incomplete SMS.</p> <ol style="list-style-type: none"> 1. Your phone's memory is full. <ul style="list-style-type: none"> ▶ Delete old SMS messages (page 64). 2. The service provider has not yet sent the rest of the SMS.
<p>You have stopped receiving SMS messages.</p> <ol style="list-style-type: none"> 1. You have changed the ID of your mailbox. <ul style="list-style-type: none"> ▶ Give your SMS contacts your new ID or undo the change (page 68). 2. You have not activated your mailbox. <ul style="list-style-type: none"> ▶ Activate your mailbox (page 68). 3. Call forwarding is activated with When: All Calls for a fixed line connection, and with All Calls for the network mailbox. <ul style="list-style-type: none"> ▶ Change the call forwarding.
<p>The SMS message is played back.</p> <ol style="list-style-type: none"> 1. The "display call number" service is not activated. <ul style="list-style-type: none"> ▶ Ask your service provider to activate this function (chargeable). 2. Your mobile phone operator and your fixed line network SMS service provider have not agreed on a co-operation. <ul style="list-style-type: none"> ▶ Obtain information from your fixed line network SMS service provider. 3. Your end device has been recorded by your SMS provider as having no fixed line network SMS functionality, i.e. you are no longer registered with the provider. <ul style="list-style-type: none"> ▶ Start the registration assistant for automatic registration (see page 62). <ul style="list-style-type: none"> – Have the device (re-)registered to receive SMS messages.
<p>Messages are only received during the day.</p> <ol style="list-style-type: none"> 1. The terminal is recorded in your SMS provider's database as having no fixed line network SMS functionality, i.e. you are no longer registered with the provider. <ul style="list-style-type: none"> ▶ Start the registration assistant for automatic registration (see page 62). ▶ Obtain information from your fixed line network SMS service provider. ▶ Register the terminal (again) for SMS reception (see above).

Operating the base station answer machine

You can operate the answer machine that is integrated in the base station via the handset or via remote operation (other phone/mobile phone). You can record your own announcement message or advisory message via the handset.

Receive numbers

You can use your phone's Web configurator to set which of your phone numbers your answer machine is to accept as soon as it is switched on (page 145). You can assign your phone any amount of phone numbers as receive numbers (VoIP, fixed line network, Gigaset.net).

All calls accepted by the answer machine are stored in sequence in the answer machine independently of the receive number and displayed in the same answer machine list.

Any registered handset to which at least one receive number from the answer machine has been assigned as a send or receive number can access the answer machine list (page 144).

After a new phone number is configured (a new VoIP account), it is first assigned to the answer machine as a receive number.

Parallel calls

If a caller is connected to the answer machine and a second call for the answer machine comes in on a different line (fixed line network or VoIP), the second caller hears the ringing tone. The answer machine will answer the second call if:

- ◆ the connection with the first caller has ended and
- ◆ the set time period for the answer machine to answer a call (page 77) has expired.

Announce only/answer and record mode

You can use the answer machine in two different modes.

- ◆ In **Ans. & Record** mode, the caller hears the announcement and can then leave a message.
- ◆ In **Announce Only** mode, the caller hears your announcement but cannot leave a message.

Operation via the handset

The handset loudspeaker activates **automatically** if you receive an acoustic prompt or message while operating. You can switch it off with the handsfree key .

Activating/deactivating the answer machine

 →  **Settings** → **Voice Mail** → **Local AM** → **Ans Machine** (= on)

When the answer machine is activated, the remaining memory time is announced. If the time has not yet been set (page 13), an appropriate announcement is made. The  icon appears in the display.

The answer machine accepts calls for all the receive numbers assigned to it (page 145).

Operation via the handset

In answer and record mode

If the memory is full the answer machine automatically switches to announce only mode.

- ▶ Delete old messages.

The answer machine reverts automatically to answer and record mode.

Selecting announcement mode

You can choose between **Ans. & Record** and **Announce Only**.

 →  **Settings** → **Voice Mail** → **Local AM** → **Announcements** → **Set Ans. Mode** → **Ans. & Record / Announce Only** (= on)

 Press and **hold** (idle status).

The selected mode is saved even after the answer machine is deactivated.

The selection process will be cancelled if the message memory is already full when you change to **Ans. & Record** mode. You will be requested to delete old messages. The answer machine stays in announce only mode **Announce Only**.

- ▶ Delete old messages.

Only after messages have been deleted can you switch the answer machine to answer and record mode.

Setting "Answer & Record" or "Announce Only" by toggling

You can use the **Ans Mode Time** setting to change over the announcement mode for a specific period.

Example: **Ans. & Record** mode is set. If you activate **Ans Mode Time** and set the time period **From:** 18.00, **Until:** 08:00 the answer machine will switch to **Announce Only** mode every day at 18:00 (if it is switched on). It will switch back to **Ans. & Record** mode at 08:00 the next day.

 →  **Settings** → **Voice Mail** → **Local AM** → **Announcements** → **Set Ans. Mode** → **Ans Mode Time** (= on)

- ▶ Change multiple line input:

From:

Enter hours/minutes for the start of the period in 4-digit format.

Until:

Enter hours/minutes for the end of the period in 4-digit format.

Activation:

Select **On** or **Off**.

- ▶ Save changes with **Save**.

If the messages memory is full and **Activation: On** has been selected, saving is interrupted and you will receive an instruction to delete old messages.

- ▶ Delete old messages and repeat the setting.

As soon as you change the announcement mode (page 72), the **Ans Mode Time** function is automatically deactivated. You may have to reactivate it if required.

If you do not enter a time for **From:** / **Until:**, **Ans Mode Time** will still be activated but the machine will not switch to announcement mode.

Recording a personal announcement/notification



Pre-recorded announcements are stored in your telephone for both announcement modes. The pre-recorded announcements are used if there is no personal announcement for the mode concerned.

 →  Settings → Voice Mail → Local AM → Announcements → Record Announce / Record Anc Only

OK Press the display key to start the recording.

When the recording starts, the handset changes to handsfree mode. You hear the ready tone (short tone).

▶ Now speak your announcement (at least 3 secs.).

Use  or  to cancel recording and **OK** to restart the recording process.

The recording is cancelled if the answer machine memory is full.



▶ Delete old messages and repeat recording if required.

Stop recording:

End Press the display key.

After recording, the announcement is played back for you to check.



You can re-record the announcement with **New**.

You can cancel the playback by pressing  or .

Please note:

- ◆ Recording ends automatically if the maximum recording time of 170 seconds is exceeded or there is a break in speech for more than 2 seconds.
- ◆ If you cancel the recording, the previously recorded announcement will be deleted. The pre-recorded announcement will be used again.
- ◆ The recording is cancelled if the answer machine memory is full.
 - ▶ Delete old messages and repeat recording if required.
- ◆ If an external call is received during a recording for one of the handset's receive numbers, the recording is interrupted and the call is signalled on the handset.

Playing back announcements



 →  Settings → Voice Mail → Local AM → Announcements → Play Announce / Play Anc Only

If you have not recorded a personal announcement, the relevant pre-recorded announcement is played.

Record a new announcement while playing back the announcement:

New Press the display key. For further information, page 73.

Deleting announcements/announce only

 →  **Settings** → **Voice Mail** → **Local AM** → **Announcements** → **Del Announce / Del Anc Only**

Yes Press the display key to confirm the prompt.

 Press and **hold** (idle status).

Once you have deleted your announcement, the relevant pre-recorded announcement will be used again. You cannot delete the pre-recorded announcements.

Playing back messages

New messages that have not yet been heard are indicated by the ∞ icon in the display and by the  key flashing on the handset.

You can start to play back the messages in two ways:

- ◆ Open the answer machine list with the message key.
- ◆ If the answer machine is set for fast access (page 78): press and **hold** key .

Please note:

All messages are played back irrespective of their receive number.

Listening to messages via the answer machine list

Precondition: At least one of your handset's send/receive numbers matches the receive number of a stored message.

The date and time of each message is logged in the answer machine list (provided it has been set, page 13) and displayed during the playback. If Calling Line Identification is activated, the caller's number is displayed. If the caller's number is saved in the directory, their name is displayed.

 Press the message key.

Ans M.: Select and press **OK**.

An announcement informs you if there are new or old messages.

If there are new messages, playback begins with the first new message. If the message has been saved with the date and time, you will hear an appropriate announcement before playback begins. All messages are played back irrespective of the receive number.

After the last new message you will hear the end tone and an announcement about how much recording time remains.

You can listen to old messages if there are no more new messages. Begin playback as described above.

Listening to messages via key

Preconditions: The answer machine has been set to fast access (page 78). At least one of your handset's send/receive numbers matches the receive number of a stored message (page 145).

▶ Press and **hold** key .

The stored messages are now played back.

Pausing and controlling playback

During message playback:

2 abc Pause playback. Press **2 abc** again to resume.

⏮ or **1 op** Skip to the previous message.

⏭ or **3 def** Skip to the next message.

2 x **⏭** Skip to next-but-one message.

If playback is interrupted for over a minute, the answer machine returns to idle status.

Marking a message as "new"

A previously played back "old" message is displayed as a "new" message again.

During message playback or pause:

*** Δ** Press the star key.

Or:

Options Open menu.

Mark as New

Select and press **OK**.

Playback of the current message is cancelled. Playback of next message starts, if applicable.

The **✉** key on the handset flashes.

Copying the phone number of a message to the directory

See "Copying a displayed number to the directory", page 53.

Deleting messages

You can either delete all old messages together or individually.

Deleting all old messages

During playback or pause:

Options Press the display key.

Del All Old Msgs

Select and press **OK**.

Yes Press the display key to confirm the prompt.

All the old messages are deleted – regardless of the receive number.

Deleting individual old messages

During playback or pause:

Delete / **0 +** Press the display key or **0 +** key.

Please note:

You can delete a new message as soon as playback has started.

Operation via the handset

Picking up a call from the answer machine

You can pick up a call while the answer machine is recording or is being operated via remote operation:

 / **Accept**

Press the talk or display key.

Recording stops and you can speak to the caller.

If 3 seconds of the call have already been recorded when you pick it up, the call will be displayed as a new message. The  key on the handset flashes.

Forwarding an external call to the answer machine

You can forward an incoming external call to the answer machine.

Preconditions: There is sufficient free memory space. One of your handset's send/receive numbers matches a receive number of the answer machine.

An external call is signalled on the handset:



Press the display key.

The answer machine starts immediately in recording mode and records the call. The set time for the call acceptance (page 77) is ignored.

The display key  will not be displayed if the memory is full.

Activating/deactivating two-way recording

You can record an **external** call with the answer machine.

Precondition: You are conducting an external call. At least one of the handset's send/receive numbers is assigned to the answer machine as a receive number (page 145).

► Inform the caller that the call is being recorded.

Options

Press the display key.

Two Way Record

Select and press **OK**.

The two-way recording is indicated on the display by an advisory text and is added to the answer machine list as a new message.

End

Press the display key to stop the two-way recording.

The maximum recording time depends on the memory available on the answer machine. If the memory is full, you will hear an end tone and the recording is aborted. The conversation recorded up to the end tone is then allocated to the answer machine list as a new message.

Please note:

You can activate two-way recording for conference calls and toggling when making calls via a fixed line network.

Activating/deactivating call screening

During recording of a message you can screen a call via the handset loudspeaker.

Precondition: The number called is assigned to the handset as a receive number (page 144).

Permanently activating/deactivating call screening

 →  **Settings** → **Voice Mail** → **Local AM**

Call Screening

Select and press **OK** ( = on)

 Press and **hold** (idle status).

Deactivating call screening for the current recording

You can deactivate the **Call Screening** function for the current call during recording via the handset.

 Briefly press the end call key.

Setting up the answer machine

The answer machine has already been preset at the factory. Make individual settings using the handset.

Call acceptance/charge saving function for remote operation

You can set when you want the answer machine to accept a call.

The options are: **0 sec.**, after **10 sec.**, **18 sec.** or **30 sec.** and the cost-saving setting **Automatic**.

In **Automatic** mode, the following applies for call acceptance:

- ◆ If there are no new messages, the answer machine accepts a call after **18 seconds**.
- ◆ If new messages are present, the answer machine accepts a call after **10 seconds**.

When operating remotely you can tell after approx. 15 seconds that there are no new messages (otherwise the answer machine would already have accepted your call). There will be no call charges if you hang up now.

 →  **Settings** → **Voice Mail** → **Local AM** → **Ring Delay**

 Select **0 sec. / 10 sec. / 18 sec. / 30 sec. / Automatic**.



Save Press the display key.

 Press and **hold** (idle status).

Assigning the answer machine to key 1 for fast access

Setting the recording time

You can set the maximum recording time of a message. You can choose between: **60 Sec**, **120 Sec**, **180 Sec** or **Maximum**.

 →  **Settings** → **Voice Mail** → **Local AM** → **Message Length**

 Select the recording time.

Save Press the display key.

Setting the recording quality

Set the quality you require for your recordings. The options are: **Standard**, **High**, **Excellent**. If the quality is higher, the maximum recording time is reduced.

 →  **Settings** → **Voice Mail** → **Local AM** → **Record Quality**

 Select the recording quality.

Save Press the display key.

Please note:

Your announcements are always recorded in best quality.

Assigning the answer machine to key 1 for fast access

You can assign the local answer machine or one of your network mailboxes to key  for fast access (page 95). This setting is handset-specific.

Configuring the local answer machine for fast access

Precondition: At least one of your handset's send/receive numbers matches a receive number of the answer machine.

 →  **Settings** → **Voice Mail** → **Set Key 1**

Local AM Select and press **OK**.

 Press and **hold** (idle status).

Listening to messages on the answer machine

Precondition: The answer machine is set for fast access on the handset.

 Press and **hold**.

The messages are now played back. Hands-free operation is activated. You will hear the answer machine announcement.

 If necessary, press the hands-free button to switch it off.

Operating when on the move (remote operation)

You can check and activate your answer machine from any other telephone (hotel, pay phone etc.), or initiate ringback from the answer machine with an SMS.

Preconditions:

- ◆ You have set a system PIN other than 0000 (page 114).
- ◆ The phone you are using for remote operation has touch tone dialling (DTMF), i.e. you hear different tones when you press the keys. Alternatively, you can use a code transmitter (available from your mobile phone retailer).

Please note:

Remote operation via VoIP connections is possible as long as DTMF signals are transmitted (depending on the provider) as SIP info messages, audible signals in the voice channel (inband or audio) or as special RTP data packets (pursuant to RFC2833).

Calling the answer machine and playing back messages

Precondition: Your answer machine is activated.



Dial your own number that is assigned to the answer machine as a receive number.



When you hear your announcement, press **9** and enter the system PIN.

You will be informed whether any new messages have been recorded. The messages are now played back. All messages are played back irrespective of their receive number. After the new messages, the old messages are played back. Finally, the remaining memory time is given.

You can control message playback by means of the keypad.

Please note:

The answer machine will terminate the connection under the following circumstances:

- an incorrect system PIN has been entered.
- there are no messages in the answer machine
- after the remaining memory announcement

Operating the answer machine via the keypad

The following keys are used for operation:

1

Previous:

Go to the start of the current message. Press repeatedly to go to the previous messages.

2

Stop/resume:

Stop playback: Press again to resume.



If there is a pause lasting longer than one minute, the connection to the answer machine is terminated.

3

Next:

Skip to next message. Press several times to go to the following messages.

Operating when on the move (remote operation)

-  New:
Mark current message as "new". Start playback of the following message.
-  Delete:
Delete current message.

Cancelling remote operation

- ▶ Press the end call key or replace the receiver.

Activating the answer machine

- ▶ Phone home and allow to ring for around a minute. Use a phone number that has been assigned to the answer machine as a receive number.

You hear: "Please enter PIN".



Enter system PIN.

Your answer machine will be activated in the set mode (page 72). It tells you how much memory time is left.



The messages are now played back.

The answer machine cannot be deactivated remotely.



E-mail notifications

Your phone will notify you when new e-mail messages have been received on your incoming e-mail server.

You can set your phone to periodically connect to your incoming e-mail server and check whether you have new e-mail.

Any new messages that have been received are displayed on all Gigaset C47H handsets that have been registered: you will hear an advisory tone, the message key  will flash and the  icon will be displayed in the idle display.

Please note:

The  icon is also displayed if new SMS messages or messenger messages have been received. If new e-mail messages have been received, pressing the message key  will display them in list E-mail.

You can use your phone to connect to the incoming e-mail server and display the sender, date and time of receipt and subject for every e-mail message in the list of incoming mail (page 81).

Preconditions:

- ◆ You have set up an e-mail account with an Internet provider.
- ◆ The incoming e-mail server uses the POP3 protocol.
- ◆ You have stored the name of the incoming e-mail server and your personal access data (account name, password) in the phone (page 154).

Opening the incoming mail list

 →  Messaging → E-mail

Or if new e-mail messages have been received (the message key  is flashing):

 → E-mail:

The telephone establishes a connection to the incoming e-mail server. A list of e-mail messages that are stored there will be displayed.

New unread messages appear above old read messages. The most recent entry is at the head of the list.

The following details are displayed for each e-mail: name or e-mail address of the sender (one line, abbreviated if necessary) and date and time (date and time will only display correct values if sender and recipient are located in the same time zone).

Opening the incoming mail list

Example display:

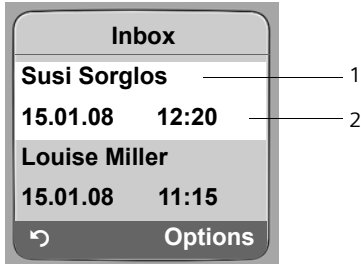

1 E-mail address or name transmitted by the sender

Bold: New message.

2 Date and time of receipt of e-mail message

If the incoming message list on the incoming e-mail server is empty, **No entries** will appear in the display.

Please note:

Many e-mail providers operate standard spam protection measures. E-mail messages classified as spam are stored in a separate folder and are therefore not shown on the list of incoming mail. Some e-mail providers allow you to deactivate spam protection or show spam e-mails on the list of incoming mail.

Other e-mail providers may send a message to the Inbox when a new spam e-mail is received. This is to inform you that a suspected spam e-mail has been received.

Date and sender of this mail are repeatedly updated, so that it is always displayed as a new message.

Messages when establishing a connection

The following problems may occur when connecting to the incoming e-mail server. The messages are displayed in the handset's display for a few seconds.

Server not accessible!

The connection to the incoming e-mail server could not be established. This may have the following causes:

- Incorrect entry for name of incoming e-mail server.
- Temporary problems with the incoming e-mail server (server is down or is not connected to the Internet).
 - ▶ Check settings (page 154).
 - ▶ Try again later.

Currently not possible!

The resources your phone requires to make the connection are busy, e.g.:

- Two VoIP connections have already been made
- Another handset is currently connected to the incoming e-mail server.
 - ▶ Try again later.

Log-in failed!

Error when logging in to the incoming e-mail server. This may have the following cause:

- Incorrect entries for name of incoming e-mail server, user name and/or password.
 - ▶ Check settings (page 154).

Mailbox settings incomplete!

Incomplete entries for name of incoming e-mail server, user name and/or password.

- ▶ Check settings and complete if necessary (page 154).

View the message header of an e-mail

Precondition: You have opened the incoming mail list (page 81).



Select e-mail entry.

Subject

Press the display key.

The subject of the e-mail message will be displayed (max. 120 characters).



Press the display key to return to the incoming message list.

Please note:

If the header is formatted in HTML it may be displayed differently to headers on the PC email client.

View e-mail sender's address

Precondition: You have opened the incoming mail list (page 81).



Select e-mail entry.

From

Press the display key.

The sender's e-mail address is shown in full.



Press the display key to return to the incoming message list.

Example:

**Deleting an e-mail**

Precondition: You have viewed the message header or the sender's address of an e-mail (page 83).

- ▶ Select **Options** → **Delete E-mail** and press **OK**.

The e-mail is deleted from the incoming e-mail server.

Messenger

The messenger on your phone makes **instant messaging** possible (immediate message transfer, chatting). The phone supports the XMPP Messenger (Jabber).

Instant messaging refers to communication between "friends" on the Internet. Subscribers exchange short messages, which are forwarded immediately. This gives rise to a flowing "conversation" similar to chatting.

The precondition for this form of communication is that both subscribers have a connection to the **messenger server** of the same instant messaging provider. Therefore, both subscribers must be "**online**". The messenger server forwards the messages to the recipient.

The subscribers to instant messaging are called **buddies**.

Most messenger servers allow you to create what are known as **buddy lists**. You can store the buddies you want to chat to in the buddy list.

The messenger server informs you as soon as one of your buddies comes online or goes offline. **Offline** means that the buddy has disconnected from the messenger server.

In addition to this, each buddy can determine their own (communication) **status (state of presence, see page 87)**, from which buddies can tell whether they are in the mood to chat or wish to remain undisturbed.

The Web configurator on your phone gives you the following options:

- ◆ Go **online** (page 85).
- ◆ Display the list of your contacts (**buddies**) on the handset that you previously created on the PC. This will indicate for each buddy whether they are available (**online**) and ready to chat (**state of presence, see page 87**).
- ◆ Exchange messages with your buddies. Your handset notifies you about new messages with a flashing message key  and a beep.
- ◆ Call your buddies directly from your buddy list (page 92).

Preconditions for instant messaging:

- ◆ You have registered with an instant messaging provider via the Web browser on your PC and (optionally) agreed a Web name (nickname).
- ◆ You have created a buddy list via the messenger client on the PC.
- ◆ You have saved the messenger server address and your access data for the messenger server (user ID, password) in the phone using the Web configurator (page 152). The phone needs the data to establish a connection with the messenger server.

Please note:

If your instant messaging provider doesn't support the phone's messenger client, then you can open an account with an open Jabber server and use the Web configurator to enter its address in your phone. Many of these Jabber servers offer gateways to other messenger servers (e.g. AOL, ICQ, MSN, Yahoo!).

You can find a list of Jabber servers and an overview of the gateways to other messenger servers on the Internet at

<http://www.jabber.org>.

You can find information on setting up a Jabber account with connections from ICQ, MSN or Yahoo on the Internet, e.g. at: <http://web.swissjabber.ch>

Establishing a connection, going online

When you go online, your buddy list will be displayed on the handset and you will receive messages from your buddies.

Only one of the handsets connected to the base station can connect to the messenger server. You can then only "chat" on this handset.

An external call will interrupt the "chat", but you will still be online. You can continue your chat after you end or reject the call.

Precondition: You have saved the messenger server address and your access data for the messenger server (user ID and password) in the phone using the Web configurator (page 152).

 →  Messaging → Messenger

Yes Press the display key to confirm the prompt.

The phone attempts to establish a connection. You are informed about the status of the connection by messages on the display.

If the connection can be established, you are **Online**. The display will show the submenu for your messenger. You can open your buddy list, send and receive messages and call your buddies.

The following is displayed when the handset is in idle status:

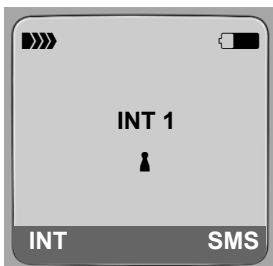

You remain online until you set your status to **Offline** (page 86) or the connection to the messenger server is terminated (page 93).

You also remain online if you press the end call key .

If the connection cannot be established, you will receive an appropriate message. Please try again later (page 93).

Please note:

You can also assign the messenger to one of the display keys on your handset (page 108). The connection is established when you press the display key.

Lost connection

If your phone loses its connection to the messenger server, the display key  will flash on the handset that had been connected to the messenger. In idle status it will display "**Messenger connection failed!**". All messages that you had previously received, as well as any message you were currently writing, will be saved.

Reconnecting:



Press the message key.



Press the display key to confirm the prompt.

The phone will attempt to reconnect. You are informed about the status of the connection by messages on the display.

If you reply to the request with **No** the phone will behave as during regular disconnection. All messenger messages will be deleted. The phone is offline.

Changing/checking your personal status, going offline

You want to log off (go offline) or let your buddies know whether you wish to chat or would prefer to remain undisturbed.

You have the following options:

Offline

You log off from the messenger server. The messenger server informs your buddies that you are no longer available.

The handset switches to idle status. You can neither send nor receive messages.

Online

(Setting after successful connection)

You are logged on to the messenger server and can send and receive messages.

Ready for chat

You are **Online** and can send and receive messages.

You invite your buddies to "chat" with you.

Away / Extended Away / Do not disturb

You are **Online** and can send and receive messages. You inform your buddies that you currently cannot/do not wish to "chat", i.e. will not reply to their messages immediately.

Invisible

You are **Online** and can send and receive messages.

However, the messenger server indicates to your buddies that you are **Offline**.

Please note:

All status settings apart from **Offline** only inform other buddies about your communication status. Whether this information is passed on to your buddies depends on the provider.

Changing status

 →  **Messaging** → **Messenger** → **User Status** → **Change Status**

 Select status and press **OK** (= on).

 Press **and hold** if necessary (idle status).

Disconnect, go offline

▶ Select **Offline** status, and respond **Yes** to the security prompt.

The connection to the messenger server will be terminated. The handset returns to idle status. New messenger messages are no longer sent to you. The messenger message list is deleted. The buddy list is no longer available.

Please note:

Whether messages directed to you are deleted or stored in the messenger server depends on the provider. Stored messages are sent to you when you go online again.

Checking your status and user ID

 →  **Messaging** → **Messenger** → **User Status** → **Info**

If you are online, the following information may be displayed (depending on your provider):

- ◆ Your Web name (nickname, abbreviated if necessary)
- ◆ Your current status
- ◆ Your user ID (format: userid@provider-domain; abbreviated if necessary)

Only **Offline** will be displayed if you are offline.

Opening the buddy list

Precondition: You are **Online** and have already created a buddy list (using the PC) on your provider's messenger server.

 →  **Messaging** → **Messenger** → **Buddies**

Only the first 20 (maximum) buddies on the buddy list will be read by the messenger server and displayed on the handset. The number depends on the available memory space.

The buddies that are displayed depend on which buddies were transferred from the messenger server first.

Please note:

You can also receive and respond to messages from buddies who are not on the list displayed on the handset.

Opening the buddy list

Example:



The Web names (nicknames) of your buddies are displayed on the list. If they do not have a Web name, the user ID is displayed.

If the name of a buddy is longer than one line, it will be abbreviated. You can navigate the list with the control key .

The buddies appear on the list in the following order. You can interpret their status (page 86) by means of the colour of the next to the buddies :

1. Buddies with **Online** status or **Ready for chat** in alphabetical order. The is **green**.
2. Buddies with **Away**, **Extended Away** or **Do not disturb** status in alphabetical order. The is **orange**.
3. Buddies with **Offline** or **Invisible** status in alphabetical order. The is **red**.

Please note:

The buddy list will remain open until you exit it (press and release or press and hold).
The handset will not automatically return to idle status.

Changes in the status of buddies

You have opened the buddy list and one of the buddies changes their status. The following distinctions are made:

- ◆ A buddy changes to status **Online / Ready for chat** :
You are informed via a message on the display. The buddy list is updated.
- ◆ In the event of another status change, the buddy list is updated. No message is displayed.

Please note:

If the buddy changes to **Offline** status, your messages are no longer sent to them. Whether the messenger server stores the messages until the buddy is **Online** again or deletes them depends on the provider.

Requesting information about buddies

You have opened the buddy list (page 87).



Select buddy.



Press the display key.

The display depends on the provider.

Example:

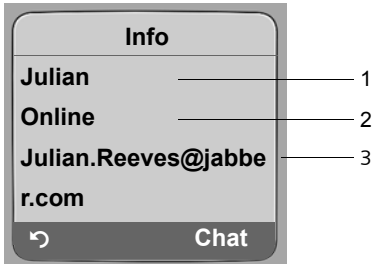

1 Web name (nickname, abbreviated if necessary)

2 Status

3 User ID (format: userid@provider-domain; abbreviated if necessary). (Resource names are not displayed)

If the buddy changes their status the entry is updated.

Press to return to your buddy list. Press **Chat** if you want to "chat" with the buddy.

Chatting to buddies

You want to "chat" to a buddy, i.e. send a message.

Precondition: You have opened the buddy list (page 87) and selected a buddy with .

▶ Press the display key **Chat**. The text editor is opened.

▶ Write and send your message (page 91).

The buddy list is shown again.

Receiving messages

Precondition: You are online.

Newly arrived buddy or info messages (page 90) are indicated by a flashing message key



and a beep, even if you are in a messenger menu or text editor.

The messages are stored in the **Messenger**: list.

Please note:

The **Messenger** list is only displayed if you are online.

Opening the message list using the key

The message key flashes.



- ▶ Press the message key .
- ▶ Select **Messenger: (2)** list if required and press **OK**. The number in brackets indicates the number of new messages.

Please note:

If you are in the messenger menu or one of its submenus/text editors and you press the flashing message key , this will open the **Messenger** list directly.

To open the message list from the menu:

In the handset idle status:

-  →  **Messaging** → **Messenger** → **Messages**
 Select and press **OK**.

Message list

The messages on the list are sorted chronologically, with the oldest message at the head of the list.

Example of a list display:

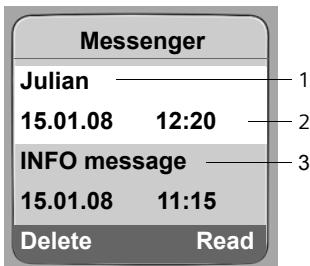

- 1 Sender's Web name/user ID
Bold: new/unread message
- 2 Date and time of message
- 3 Message from the messenger server (page 90)

If the memory is full and new messages arrive, the oldest message(s) will be overwritten. If there are no old (read) messages, the oldest (unread) messages will be overwritten.

Message types

In instant messaging, a distinction is made between the following types of message:

- ◆ **Buddy messages** are the "instant messages" you receive from your buddies. You can answer the messages.
- ◆ **Info messages** are special information from the provider. They are forwarded to you, but you cannot reply to them.

Example: With some messaging providers you receive an info message when another subscriber tries to add you to their buddy list. You are prompted to check the messages on the messenger client on your PC.

Via the messenger client on your PC you can agree to the action or refuse permission. Without your agreement, the other subscriber cannot add you to their buddy list.

Reading messages

Precondition: You have opened the message list and selected a message with .

- ▶ Press the display key **Read**.

The message is opened for you to read.

You have the following options:

Delete Delete a message from the list You will return to the message list.

Or:

Answer (for buddy messages only)
Reply to message. The text editor is opened. You can write a reply (see "Writing and sending messages" on page 91).

Or:

 Back to the message list.

Delete message

Precondition: You have opened the message list and selected a message with .

- ▶ Press the display key **Delete**.

Writing and sending messages

Precondition:

- ◆ You are reading a buddy's message and press the display key **Answer** or
- ◆ You have pressed the display key **Chat** in the buddy list or the buddy profiles.

A text editor is opened.

- ▶ Use the handset keys to enter a message (max. 612 characters).
- ▶ Select **Menu** → **Send** and press **OK**.

The message is sent to the buddy.

If the messenger server is unable to send the message to the buddy, a message will be displayed.

- ▶ Confirm the message by clicking **OK**.

The text-editor will re-open with your message. You can then retry sending the message.

Interruption while writing

If you receive a call while you are writing a message or the connection to the messenger server is interrupted, the text editor is terminated. Your message is stored temporarily until ...

- ◆ ... you start up a chat with the same buddy (page 89). The text editor is opened with the stored text. You can finish writing the message and send it.
- ◆ ... you wish to write a message to another buddy. The stored text is deleted. The text editor is empty.
- ◆ ... you go offline. The text is deleted.

Menu options for the text editor

By pressing **Menu** within the text editor you have the following options:

Send

Send message to buddy.

Delete Text

Delete the whole text.

Calling a buddy

You can call a buddy directly.

Precondition: The messenger server supports calls using vCard and your buddy's vCard contains a phone number.

Preconditions:

- ◆ You have opened the buddy list and selected a buddy
 - or
- ◆ You have opened the buddy's profile
 - or
- ◆ You have opened the **Messenger:** list and selected a buddy
 - or
- ◆ You are reading a message from a buddy

 /  Press and **release/hold** the talk or handsfree key.

The phone will try to establish a VoIP/fixed line connection.

The first number that is found on the vCard will be dialled.

Ending a call

 Press the end call key.

Self-help with errors

While establishing a connection to the messenger server, during connection and when sending messages the following errors may occur.

Behaviour when the connection is lost

If the connection to the messenger server is interrupted, an appropriate message is shown in the display. You are **Offline**.

If you are in a submenu of the messenger, the handset switches to the messenger menu.

- ▶ Try to re-establish the connection (page 85).

Errors when sending

If it is not possible to send a message, a distinction is made between the following situations:

- ◆ The connection to the messenger server is interrupted:
 - A message is shown in the display to indicate that the connection to the messenger server has been interrupted.
 - The message is stored temporarily (page 92).
 - ▶ Try to re-establish the connection (page 85) and send the message again.
- ◆ The server is unable to send the message:
 - A message is shown in the display to indicate that the message could not be sent. If, for example, the buddy is not available, the message you have sent will also be displayed.
 - The message is stored temporarily (page 92).
 - ▶ If necessary, check the buddy's user ID and send the message again later.

Using the network mailbox

Some fixed network providers and VoIP providers offer answer machines on the network – these are known as network mailboxes.

Each network mailbox accepts incoming calls made via the corresponding line (fixed line network or corresponding VoIP phone number). To record all calls, you should therefore set up network mailboxes for both the fixed line network and for each of your VoIP connections.

You need to have **requested** the network mailbox for your fixed line network connection from your fixed line network provider. You can store the phone number for the fixed line network mailbox in the base station.

You can activate/deactivate the network mailboxes for your VoIP connections using your handset or the Web configurator. To do this, you only require the network mailbox phone number.

Activating/deactivating network mailbox, entering numbers

You can manage the network mailboxes on your handset that are assigned to a receive number on the handset.

 →  **Settings** → **Voice Mail** → **Network AM(s)**

The list of connections (VoIP and fixed line network) that are assigned to the handset as receive numbers is displayed. The display shows **Net AM: xxx**, where xxx is replaced by the relevant default name for the connection (**IP1 to IP6, Fxd. line**).

 Select connection and press **OK**.

You have selected a VoIP connection:

- ▶ Change multiple line input:

Status

Select **On** to activate the network mailbox. Select **Off** to deactivate.

Number

The number that is currently stored for the network mailbox is displayed.

Enter or change the phone number for the network mailbox if necessary.

With some VoIP providers your network mailbox phone number will be downloaded together with the general VoIP provider data (page 134), saved to your base station and displayed under **Number**.

You have selected the fixed line network connection:

Number

Enter or change the phone number for the network mailbox.

You cannot activate/deactivate the network mailbox for the fixed line network connection via the handset. For how to activate/deactivate the network mailbox for the fixed line network connection please refer to the fixed line network provider's information.

Please note:

For information on how to activate and deactivate network mailboxes via the web configurator and to change their assigned numbers, see, see page 151.



Configuring the (network) mailbox for fast access

You can use fast access to make direct calls to a network mailbox or the Gigaset C475 IP's integrated answer machine.

Assigning key 1 of the handset, changing assignments

The setting for fast access is handset-specific. You can assign a different answer machine to key  on each registered handset.



No answer machine is preconfigured for fast access in the default settings.

 Fast access is not yet set on the handset: Press and hold the key .

Or:

 →  **Settings** → **Voice Mail** → **Set Key 1**

The list of connections (VoIP and fixed line network) that are assigned to the handset as receive numbers is displayed. The display shows **Net AM: xxx**, where xxx is replaced by the relevant default name for the connection (**IP1 to IP6, Fxd. line**) and (if available) **Local AM** for the integrated answer machine on the Gigaset C475 IP base station.

 Select connection and press **OK** ( = on).

If a number is already saved to the base station for the selected network mailbox, fast access is activated.

 Press and **hold** (idle status).

If no number has been saved for the network mailbox a message is displayed to this effect.

You will be prompted to enter the number for the network mailbox.

 Jump to the **Number** line.

 Enter the number for the network mailbox.

Save Press the display key.

 Press and **hold** (idle status).

Fast access is automatically activated.

Please note:

You can only assign fast access to one answer machine.

However, you can also call the network mailbox assigned to a handset's receive numbers directly via the message key (page 96).

Calling the network mailbox

 Press and **hold**.

If you have set a network mailbox for fast access you will be connected straight to this network mailbox.

If you have set the integrated answer machine on the base station for fast access, message playback begins.

 If necessary, press the hands-free key.

You will hear the answer machine announcement.

Listening to messages on the network mailbox

Under the message key  you will find a list for each network mailbox that fulfils the following requirements:

- ◆ The corresponding connections are allocated to the handset as receive numbers.
- ◆ The network mailbox phone number is saved on the base station.

You can call and check the network mailbox directly from the list.

When you press the message key , the following is displayed (example):

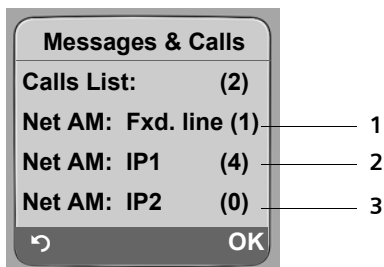

- 1 "Fxd. line ", "IP1" etc. are the default names for the associated connections. The default names are always shown irrespective of which connection name you have specified when configuring via the Web configurator.
- 2 If there are new messages in the network mailbox, the list entry is shown in bold. The number of new messages is shown in brackets following the list entry.
- 3 If there are no new messages (0) is shown after the list entry for the network mailbox. The number of messages stored in the network mailbox is not displayed.

Displaying new messages in the handset's idle status

If a new message is present on one of the network mailboxes to which the handset is allocated via its receive number, or there is a new message on the integrated answer machine, the  icon and the number of new messages are shown on the handset's idle display. The

 message key flashes.

Calling the network mailbox and checking messages



Press the message key.

Net AM: Fxd. line / Net AM: IP1 / ...

Select the network mailbox and press **OK**.

You are connected directly to the network mailbox and hear its announcement. Messages can generally be played back using your handset keypad (digit codes). Listen to the announcement.

Please note:

- The network mailbox is automatically called via the corresponding connection. An area code pre-defined for your phone is **not** prefixed.
- Network mailbox messages can generally be played back using your handset keypad (digit codes). You need to define how the digit codes for VoIP should be converted to DTMF signals and transmitted (page 146).
Ask your VoIP provider which type of DTMF transmission it supports.

Using several handsets

Registering handsets

You can register up to six handsets to your base station.

When you register a new Gigaset handset, the base station transfers the following entries to its local directory to enable you to use online directories on your new handset:

- ◆ **Net Directory** for the currently active online directory (page 53)
- ◆ **Yellow Pages** for the currently active online classified directory (page 53)
- ◆ **Gigaset.net** for the Gigaset.net directory (page 40)

Precondition: The handset can send and receive directory entries (see handset operating instructions).

Successful registration is acknowledged with a **Data Transfer x entries received** for this reason.

Please note:



- If a number of handsets are registered on your base station, you can simultaneously make two calls via the Internet and one via the fixed line network. Up to two additional internal connections are also possible.
- Selecting the connection via the talk key (page 30) is not supported on GAP handsets. Therefore, if you enter a number without a line suffix and without defining a dialling plan for the phone number, it will be dialled via **Default Line** (page 116). If you enter a "*" (star) at the end of the phone number, it will be dialled via the non-default connection.
- After registration, all the phone numbers for the phone will be assigned to the handset as receive numbers. It will use the fixed line network number and the first VoIP number as send numbers. For how to change the assignments, see page 144.

Registering another Gigaset C47H handset on the Gigaset C470 IP/C475 IP

Before you can use your handset, you must register it to a base station.

You must initiate handset registration on the handset and on the base station.

The handset will change to idle status if registration was successful. The handset's internal number is shown in the display e.g. **Int 1**. If not, repeat the procedure. Registration can take up to one minute.

- ▶ **Select**  →  **Settings** → **Handset** → **Register H/Set** on the handset.
- ▶ Enter the system PIN of the base station (the default is 0000) and press **OK**. The display shows e.g. **Base 1** and flashes.
- ▶ Within the next 60 seconds press and **hold** (for approx. 3 seconds) the registration/paging key (page 2) **on the base station**.

The handset is assigned the lowest available internal number (1-6). If a number of handsets are registered on the base station, the internal number appears in the display after registration, e.g. **INT 2**. This means that the internal number 2 was assigned to the handset.

Please note:

If six handsets are already registered to the base station, there are two options:

- The handset with the internal number 6 is in idle status: the handset you wish to register is assigned the number 6. The handset that was previously number 6 is de-registered.
- The handset with the internal number 6 is being used: the handset you wish to register cannot be registered.

Registering other handsets with Gigaset C470 IP/C475 IP

You can register other Gigaset handsets and handsets for other devices with GAP functionality as follows.

- ▶ Begin the registration procedure **on the handset** in accordance with the handset's operating instructions.
- ▶ Press and hold (for approx. 3 seconds) the registration/paging key (page 2) **on the base station**.

Please note:

You can also make changes on the base station with a Gigaset S45 or S67H handset.

De-registering handsets

You can de-register any registered handset from any registered Gigaset C47H handset.



Open list of internal parties.

The handset which you are using is marked with <.



Select the handset to be de-registered.

Options

Press the display key.

De-reg. H/Set No.

Select and press **OK**.



Enter the current base station system PIN (default setting: 0000).

Yes

Press the display key to confirm the prompt.



Press and **hold** (idle status).

The handset is de-registered immediately, even if it is not in idle status.

Locating a handset ("paging")

You can locate your handset using the base station.

- ▶ **Briefly** press the registration/paging key on the base station (page 2).
- ▶ All handsets will ring at the same time ("paging"), even if ringer tones are switched off.

The current (local) IP address for the base station appears in the handset displays.

Ending paging

- ▶ **Briefly** press the registration/paging key on the base station (page 2).

Or

- ▶ Press the talk key or end call key on any handset.

Changing a handset's internal number

A handset is **automatically** assigned the lowest free number on registration. In the list of internal parties, the handsets are sorted according to their internal number.

You can change the internal number of all registered handsets (1–6). Numbers 1-6 can only be assigned once each.

 Open list of handsets. Your own handset is indicated by <.

Options Press the display key.



Edit H/Set No.

Select and press **OK**. The list of handsets and their internal numbers will be displayed.

The internal number for the first handset flashes.

 Select handset.

 Enter the new internal number (1–6). The handset's old number is overwritten.

  If necessary, select further handsets and change numbers.

After all the changes are completed:

Save Press the display key to save the input.

 Press and **hold** (idle status).

You will hear the error tone if an internal number has been allocated twice.

▶ Repeat the procedure with a free number.

Changing the name of a handset

The names "INT 1", "INT 2" etc. are assigned automatically at registration. You can change these names. The changed name is displayed in every handset's list.

 Open list of handsets. Your own handset is indicated by <.

 Select handset.

Edit Press the display key.

<C Delete previous name if necessary.

 Enter the new name (max. 10 characters).

Save Press the display key.

 Press and **hold** (idle status).



Please note:

If you delete the current handset name and then press **Save** without entering a new name, the handset will automatically be allocated the standard name "INT x" (x= internal number).



Making internal calls

Internal calls to other handsets registered on the same base station are free.



Calling a specific handset

-  Initiate internal call.
-  Enter the number of the handset.

Or:

-  Initiate internal call.
-  Select handset.
-  Press the talk key.

Calling all handsets ("group call")

-  Initiate internal call.
-  Press the star key. All handsets are called.

Ending a call



-  Press the end call key.

Please note:

You can reject an internal call by pressing the end call key . Other handsets will continue to signal an internal "group call".

Transferring a call to another handset

You can forward (connect) an external call, made via fixed line network or VoIP, to another handset.

-  Open the list of handsets.
The external participant hears hold music if activated (page 115).
-  Select a handset or **Call All** and press **OK**.

When the internal participant answers:

- ▶ If necessary announce the external call.

-  Press the end call key.

The external call is transferred to the other handset.

If the internal participant does **not** answer or the line is busy, press the display key **End** to return to the external call.

When transferring a call you can also press the end call key  before the internal participant answers.

Then, if the internal participant does not answer or the line is busy, the call will automatically return to you (the display will show **Recall**).

Initiating internal consultation call, conference call

You are talking to an **external** participant (via fixed line network or VoIP) and can call an **internal** participant at the same time to hold a consultation call.



Open the list of handsets.

The external participant hears hold music if activated (page 115).



Select handset and press **OK**.

When an internal participant answers you can speak to them.

You have the following options:

Ending a consultation call



End Press the display key.

You are reconnected with the external participant.

Initiating a conference call

Conf. Press the display key.

You are in a three-way conference call with the external participant and the internal participant.

If the internal participant who has been called ends the call (press end call key ) , you will be connected with the external participant. If you press end call key , the external call will be transferred to the internal participant.

Accepting/rejecting call waiting during an internal call

If you receive an **external** call during an **internal** call, you will hear the call waiting tone (short tone). With Calling Line Identification, the caller's number will appear in the display.

Ending an internal call, accepting an external call

Accept Press the display key.

The internal call is **ended**. You are connected to the external caller.

Rejecting the external call

Reject Press the display key.

The call waiting tone is turned off. You remain connected with the internal participant. The ringer tone can still be heard on other registered handsets.

Listening in to an external call

Precondition: The **Listening In** function must be activated.

You are conducting an external call. An internal participant can listen in on this call and take part in the conversation. Listening in to a call is signalled to all participants by a tone if the signal tone is activated (see below).

Activating/deactivating listening in

 →  **Settings** → **Base** → **Add. Features**

Listening In

Select and press **OK** ( = on).



Press and **hold** (idle status).

Activate/deactivate signal tone

 →  **Settings** → **Base** → **Add. Features**

Listening In Tone

Select and press **OK** ( = on).



Press and **hold** (idle status).

Listening in

At least one line is engaged with an external call. A corresponding message is shown in the display. You want to listen in to the external call.



Press and **hold** the talk key.



If multiple external calls are being made: select the call and press **OK**.

You are linked into the call. All call participants will hear a signal tone if the signal tone function is activated. During this time, this handset displays the **Conference** message and it is not possible to dial another number from this handset.

Ending listening in



Press the end call key.

All participants hear a signal tone.

If the **first** internal participant presses the end call key , the handset that has "listened in" remains connected to the external participant.

Using a handset as a room monitor

If the room monitor is activated, a previously stored destination number is called as soon as a set noise level is reached in the room.

You can save an internal or external number in your handset as the destination number.

The room monitor call to an external number stops after around 90 seconds. The room monitor call to an internal number (handset) stops after approx. 3 minutes (depending on the base station). During use as a room monitor, all keys are barred except for the end call key . The speaker of the handset is muted.

When the room monitor is activated, incoming calls to the handset are indicated **without a ringer tone** and are only shown on the screen. The display and keypad are not illuminated and advisory tones are also turned off.

If you accept an incoming call, the room monitor is suspended for the duration of the call, but the function **remains** activated.

If you deactivate then reactivate the handset, the room monitor remains activated.

Warning!

- You should always check the operation of the room monitor before use. For example, test its sensitivity. Check the connection if you are forwarding the room monitor to an external number.
- When the function is switched on, the handset's operating time is severely reduced. If necessary, place the handset in the charging cradle. This ensures that the batteries do not run down.
- Ideally the handset should be positioned 1 to 2 metres away from the baby. The microphone must be directed towards the baby.
- The connection to which the room monitor is forwarded must not be blocked by an activated answer machine.

Activating the room monitor and entering the number to be called

 →  Add. Features → Room Monitor

▶ Change multiple line input:

Room M.:

Select **On** to activate.

Call to:

Press the display key **Edit** and enter destination number.

External number:

- ▶ Enter number directly or press  and select number from directory. Only **the last 4 digits** are displayed.
- ▶ Save number with **Save**.

Internal number:

- ▶ Press the display key **INT**.
- ▶ Select handset with  or **Call All** (if you want to call all registered handsets) and press **OK**.

Level:

Set noise level sensitivity (**Low** or **High**).

- ▶ Press the display key **Save** to save the entry.

You can use the **Options** display key to switch directly to the room monitor settings.

Please note:

An external number will be dialled via the default connection (VoIP or fixed line network) if you do not enter a line suffix (page 31) and have not defined any dialling plans for the number (page 149).

Changing the set destination number

 →  → **Room Monitor**

 Scroll to the **Call to:** line.

<C or **Delete**

Delete existing number.

- ▶ Enter number as described in "Activating the room monitor and entering the number to be called" (page 104).

Deactivating the room monitor remotely

Preconditions: The room monitor call is sent to an external destination number. The telephone called supports touch tone dialling.

- ▶ Accept the call from the room monitor and press keys **9** **#**.

Your base station sends a confirmation tone and ends the connection.

Please note:

Remote deactivation via VoIP connections is possible if DTMF signals are transmitted either as SIP info messages, as audible signals via the voice channel (inband or audio) or as special RTP data packets pursuant to RFC2833 (provider-dependent).

Room monitor function deactivated on the handset. There will be no further room monitor calls. The other room monitor settings (e.g. no ringer tone) on the handset will remain activated until you press the display key **OFF** on the handset.

To reactivate the room function with the same phone number:

- ▶ Turn on the activation again and save with **Save** (page 104).

Handset settings

Your handset is preconfigured, but you can change the settings to suit your individual requirements.

Changing the display language

You can view the display texts in different languages.

 →  **Settings** → **Handset** → **Language**

The current language is indicated by .

 Select a language and press **OK**.

 Press and **hold** (idle status).

If you accidentally choose a language you do not understand:

   
Press keys in sequence.

 Select the correct language and press **OK**.



Setting the display

You have a choice of four colour schemes and several different contrasts.

 →  **Settings** → **Display**

Colour Scheme

Select and press **OK**.

 Select a colour scheme and press **OK** ( = current colour).

 Press **briefly**.

 Scroll to the **Contrast** line.

Contrast Select and press **OK**.

 Select contrast.

Save Press the display key.

 Press and **hold** (idle status).

Setting the screen picture

You can display a picture or a screen picture (picture or digital clock) when the handset is in idle status. This will replace the idle status display. It may conceal the date, time and name.

The screen picture is not displayed in certain situations, e.g. during a call or when the handset has been de-registered.

If a screen picture has been activated, the menu item **Screen Picture** is marked with .

 →  **Settings** → **Display** → **Screen Picture**

The current setting is displayed.

▶ Change multiple line input:

Activation:

Select **On** (screen picture is displayed) or **Off** (no screen picture).

Selection:

Change screen picture if necessary (see below).

▶ Press the display key **Save**.

If the screen picture conceals the display, press the end call key  **briefly** to show the idle display with time and date.

Changing the screen picture

 →  **Settings** → **Display** → **Screen Picture**

 Scroll to the **Selection** line.



View Press the display key. The active screen picture is displayed

 Select the logo and press the display key **Save**.

▶ Press the display key **Save**.

Setting the display backlight

Depending on whether or not the handset is in the charging cradle you can set different levels of display illumination. If it is activated, the display is permanently dimmed.

 →  **Settings** → **Display** → **Backlight**

The current setting is displayed.

▶ Change multiple line input:

In Charger

Select **On** or **Off**.

Without Charger

Select **On** or **Off**.

Save Press the display key.

 Press and **hold** (idle status).

Please note:

The handset's standby time can be significantly reduced if the display backlight (**On**) is activated.

Quick access to functions

The display keys on your handset are preset to fulfil certain functions. You can change the configuration, i.e. assign other functions to the display keys.

To start the function, you then simply need to press the button.

Changing display key assignments

- ▶ Press and **hold** the left or right display key.

The list of possible key assignments is opened.

- ▶ Select a function and press **OK**.

The following features are available:

- ◆ **INT (INT)**
Opens the list of internal parties.
- ◆ **SMS (SMS)**
Opens the SMS submenu for writing, sending and reading SMS messages (page 62):
✉ **Messaging** → **SMS**
- ◆ **SMS Notific. (Notif.)**
Opens the menu for activating SMS notification (page 66):
✉ **Messaging** → **SMS** → **Settings** → **Notify Type**
- ◆ **E-mail (EMail)**
Opens the e-mail submenu for receiving and reading e-mail notifications (page 81):
✉ **Messaging** → **E-mail**
- ◆ **Messenger (Messgr.)**
Opens the Messenger submenu for chatting with friends on the Internet (page 85):
✉ **Messaging** → **Messenger**
- ◆ **Fixed Line Call (FixedLine)**
Opens the pre-dialling option for making a call via the fixed line network.
- ◆ **IP Call (IP)**
Opens the pre-dialling option for making a call via VoIP.

The current display key configuration is shown on the bottom display line above each key.

Starting a function

With the handset in idle status, press the display key **briefly**.

The function menu is opened.

Activating/deactivating auto answer

If you activate this function, when you receive a call you can simply lift the handset out of the charging cradle without having to press the talk key .

 →  **Settings** → **Handset**

Auto Answer

Select and press **OK** ( = on).



Press and **hold** (idle status).

Changing the handsfree/earpiece volume

You can set the loudspeaker volume for handsfree talking to five different levels and the earpiece volume to three different levels.

In the handset idle status:



Press the control key at the top.

Handset Volume

Select and press **OK**.



Set the earpiece volume.



Jump to the **Speaker**: line.



Set the handsfree volume.



Press display key if necessary to save the setting permanently.

Please note:

You can also adjust the call volume via  **Settings** → **Audio Settings** → **Handset Volume** in the menu.

Setting the volume during a call:



Press the control key at the top.



Select volume.

The setting will automatically be saved after approx. 3 seconds, if not then press the display key **Save**.

If  is assigned with another function, e.g. toggling (page 46):



Open menu.



Volume

Select and press **OK**.

Configure setting (see above).

Changing ringer tones

◆ **Volume:**

You can choose between five volumes (1–5; e.g. volume 2 = ) and the "crescendo" ring (6; volume increases with each ring = .

◆ **Ringer tones:**

You can select various ringer tones.

You can set different ringer tones for the following functions:

- ◆ **Ext. Calls:** for external calls
- ◆ **Internal Calls:** for internal calls
- ◆ **All:** the same ringer tone for all functions

Settings for individual functions

Set the volume and melody depending on the type of signalling required.

In the handset idle status:

 Press the control key at the top.

Ringer Settings

Select and press **OK**.

Ext. Calls / Internal Calls

Select and press **OK**.

▶ Change multiple line input:

 Set volume (1–6).

 Scroll to the next line.

 Select melody.

Save Press the display key to save the setting.

 Press and **hold** (idle status).

Same ringer tone for all functions

In the handset idle status:

 → **Ringer Settings** → **All**

▶ Set volume and ringer tone (see "Settings for individual functions").

Save Press the display key to confirm the prompt.

 Press and **hold** (idle status).

Please note:

You can also adjust the ringer tones via  **Settings** → **Audio Settings** → **Ringer Settings** in the menu.

Activating/deactivating the ringer tone

You can deactivate the ringer tone on your handset before you answer a call or when the handset is in idle status; the ringer tone can be deactivated permanently or just for the current call. The ringer tone cannot be reactivated while an external call is in progress.

Deactivating the ringer tone permanently

 Press and **hold** the star key.

The  icon appears in the display.

Reactivating the ringer tone

 Press and **hold** the star key.



Deactivating the ringer tone for the current call

 Press the display key.

Activating/deactivating the alert tone

In place of the ringer tone you can activate an alert tone. When you get a call, you will hear a **short tone** ("Beep") instead of the ringer tone.

 Press and **hold** the star key and **within 3 seconds**:

 Press the display key. A call will now be signalled by **one** short alert tone.  appears in the display.

Activating/deactivating advisory tones

Your handset uses "advisory tones" to tell you about different activities and statuses. The following advisory tones can be activated/deactivated independently of each other:

- ◆ **Key click**: every key press is confirmed.
- ◆ **Acknowledge tones**:
 - **Confirmation tone** (ascending tone sequence): at the end of an entry/setting and when an SMS or a new entry arrives in the answer machine list (Gigaset C475 IP) or call history
 - **Error tone** (descending tone sequence): when you make an incorrect entry
 - **Menu end tone**: when scrolling at the end of a menu
- ◆ **Battery tone**: the batteries need to be charged.

In the handset idle status:

 Press the control key at the top.

Advisory Tones

Select and press .

► Change multiple line input:

Key Tones:

Select **On** or **Off**.

Confirm.:

Select **On** or **Off**.

Battery:

Select **On**, **Off** or **In Call**. The battery warning tone is only activated/deactivated and only sounds during a call.

Save Press the display key to save the setting.

You cannot deactivate the confirmation tone for placing the handset in the charging cradle.

Please note:

You can also adjust the ringer tones via  **Settings** → **Audio Settings** → **Advisory Tones** in the menu.

Setting the alarm clock

Precondition: The date and time have already been set (page 13).

Activating/deactivating the alarm clock and setting the wake-up time

 →  **Alarm Clock**

▶ Change multiple line input:

Activation:

Select **On** or **Off**.

Time:

Enter the wake-up time in 4-digit format.

Melody:

Select melody.

Volume:

Set the volume (1–6).

Save Press the display key to save the setting.

The  icon is displayed in the idle display.

A wake-up call with the selected ringer melody is signalled on the handset. The wake-up call sounds for 60 seconds.  is shown in the display. If no key is pressed, the wake-up call is repeated twice at five minute intervals and then turned off.

During a call, the wake-up call is signalled by a short tone.

Deactivating the wake-up call/repeating after a pause (snooze mode)

Precondition: A wake-up call is sounding.

OFF Press the display key. The wake-up call is deactivated.

Or

Snooze Press the display key or any key. The wake-up call is deactivated and then repeated after 5 minutes. After the second repetition the wake-up call is deactivated completely.

Restoring the handset to the factory settings

Each individual handset setting is reset, in particular the language, display, volume, ringer tone and alarm clock settings (see from page 106 onwards). The last number redial list is cleared.

This will not affect entries in the directory, call-by-call list, call history, SMS lists or the handset's registration to the base station.

 →  **Settings** → **Handset** → **Reset Handset**

Yes

Press the display key.

You can cancel the factory reset by pressing  or the display key **No**.



Press and **hold** (idle status).

Base station settings

The base station settings are carried out using a registered Gigaset C47H handset.



Protecting against unauthorised access

Protect the system settings of the base station with a system PIN known only to yourself. You have to enter the system PIN if, among other things, you register and de-register a handset, change VoIP settings or reset the phone to factory settings.

Changing the system PIN

You have to enter the system pin when, for example, you register a handset with the base station, change VoIP settings or start the Web configurator.

You can change the base station's 4-digit default system PIN ("0000") to a 4-digit system PIN known only to yourself.

 →  **Settings** → **Base** → **System PIN**

 Enter the current system PIN and press **OK**.

 Enter new system PIN.

 Scroll to the **Re-enter PIN:** line.

 Now re-enter the new system PIN and press **OK**.

For security reasons, "****" is displayed instead of the system PIN.

 Press and **hold** (idle status).

Restoring the base station to the factory settings

Resetting the base station via the menu

Each individual setting is reset, in particular:

- ◆ VoIP settings such as VoIP provider and account data and DTMF settings (page 118, page 132, page 146)
- ◆ Settings for the local network (page 120, page 130)
- ◆ Default connection (page 116)
- ◆ The names of the handsets (page 100)
- ◆ SMS settings (e.g. SMS centres, page 61)
- ◆ PABX connection settings (page 122)
- ◆ On the Gigaset C47 IP:
 - Answer machine settings (page 77), and own announcements are deleted
- ◆ On the Gigaset C47 IP:
 - Answer machine settings (page 77), and own announcements are deleted

SMS lists, the answer machine list and calls list are deleted.

The following are **not** reset:

- ◆ Date and time
- ◆ System PIN
- ◆ SMS info services

The handsets are still registered.

 →  Settings → Base → Base Reset

 Enter the system PIN and press **OK**.

Yes Press the display key to confirm.

Resetting the base station using a key on the base station

As with resetting the base station via the menu, all individual settings are reset. The **system PIN will also be reset to "0000"** and **all handsets registered above and beyond the scope of delivery will be de-registered.**

Please note:

For how to reregister the handsets after resetting, if necessary, see page 98.

- ▶ Remove the cable connections from the base station to the router (page 17) and fixed line network (page 16).
- ▶ Remove the base station mains adapter from the socket (page 16).
- ▶ **Press and hold** the registration/paging key (page 2).
- ▶ Plug the mains adapter back into the power socket.
- ▶ Continue to press and hold the registration/paging key (at least 2 sec.).
- ▶ Release the registration/paging key. The base station has now been reset.

Activating/deactivating music on hold

 →  Settings → Base

Music on hold

Select and press **OK** to activate or deactivate music on hold (= on).

Activating/deactivating repeater mode

With a repeater you can increase the range and reception strength of your base station. You will need to activate repeater mode. This will terminate any calls being made via the base station at that time.

Preconditions:

- ◆ A repeater is registered with the base station.
- ◆ Eco mode is deactivated (page 24).

 →  Settings → Base → Add. Features

Repeater Mode

Select and press **OK** (= on).

Yes Press the display key to confirm the security prompt.

Setting the default connection

You can make settings according to whether you want to make calls via VoIP or the fixed line network by default.

Please note:



The standard connection is only relevant when dialling numbers that are not subject to dialling plans (page 149) and are entered without a line suffix (page 31).

 →  **Settings** → **Telephony** → **Default Line**

VoIP / Fixed Line

Select and press **OK** ( = on).

When making calls:

- ▶ Press the talk key  **briefly** if you want to make the call via the default connection.
- ▶ Press and **hold** the talk key  if you want to make the call via the other connection type.

Updating the base station firmware

If necessary, you can update your base station firmware.

The firmware update is downloaded directly from the Internet by default. The relevant Web page is preconfigured in your phone.

Precondition:

The base station is in idle status, i.e.:

- ◆ No calls are being made via the fixed line network or VoIP.
- ◆ There is no internal connection between the registered handsets.
- ◆ No other handset has opened the base station menu.

Starting the firmware update manually

 →  **Settings** → **Base**

Software Update

Select and press **OK**.



Enter the system PIN and press **OK**.

The base station establishes a connection to the Internet or to the local PC.

Yes

Press the display key to start the firmware update.

Please note:

- The firmware update can last up to 3 minutes.
- When updating from the Internet, checks are made to ensure that no newer version of the firmware exists. If this is not the case, the operation is terminated and a message is issued to that effect.

Automatic firmware update

Your phone will check daily whether a newer firmware update is available via the Internet on the Siemens configuration server. If this is the case, the message **New firmware available** will be displayed when the handset is in idle status, and the message key  flashes.

 Press the message key.

Yes Press the display key to confirm the prompt.

The firmware will be loaded onto your phone.

Please note:

- If you reply to the request with **No**, the display will not be repeated. The message **New firmware available** will only be shown again if a newer version of the firmware than the one rejected is available.
- You can deactivate the automatic version check via the Web configurator (page 161).

Making VoIP settings

In order to be able to use VoIP, you must set a few parameters for your phone.

You can make the following settings using your handset.

- ◆ Download the general access data for your VoIP provider from the Siemens configuration server and store them on your phone.
- ◆ Enter your personal access data for your first VoIP account (first VoIP phone number). You can configure the access data for five further VoIP accounts via the phone's Web configurator.
- ◆ Set the phone's IP address in the LAN.

Please note:

You can set these and other parameters conveniently via the Web configurator on a PC connected to your local network (see page 124).

The connection assistant on your phone can help you make the settings.

Using the connection assistant

The connection assistant starts automatically when you set the handset and base station up for the first time, or when you try to connect to the Internet before making the necessary settings.

You can also start the connection assistant via the menu:

 →  Settings → Telephony

Connection Assist.

Select and press **OK**.



Enter the system PIN and press **OK**.

For how to enter VoIP settings using the connection assistant, see page 19.

Changing settings without the connection assistant

You can change your provider's VoIP settings and the VoIP user data via the menu without starting the connection assistant.

Downloading your VoIP provider's settings

The general settings for various VoIP providers are available for download on the Internet. The relevant Web page is preconfigured in your phone.

Precondition: Your phone is connected to the Internet.

 →  Settings → Telephony → VoIP



Enter the system PIN and press **OK**.

Select Provider

Select and press **OK**.

The phone establishes a connection to the Internet.

 Select country and press **OK**.

 Select your VoIP provider and press **OK**.

Your VoIP provider data is downloaded and saved in your phone.

Please note:

- If an error occurs during the download, an error message will be displayed. You can find possible messages and measures in the table on page 163.
- You can make and adapt the general settings for your VoIP provider manually via your phone's Web configurator, see page 133.

Automatic update for the VoIP provider settings

After the first download of the VoIP provider settings, your phone will check daily whether a newer version of the file for your VoIP provider is available via the Internet on the Siemens configuration server. If this is the case, when the handset is in idle status the message **New profile available** will be displayed, and the message key  flashes.

 Press the message key.

Yes Press the display key to confirm the prompt.

 Enter the system PIN and press **OK**.

The new data for your VoIP provider will be downloaded and saved on the phone.

Please note:

- If you reply to the prompt with **No**, the display will not be repeated. The message **New profile available** will only be shown again if a newer version of the VoIP settings than the one rejected is available.
- You can deactivate the automatic version check via the Web configurator (page 161).

Entering/changing VoIP user data

The VoIP settings must also be extended for your personal data. You will receive all necessary data from your VoIP provider.

Please note:

When making these entries, please remember the VoIP user data is case sensitive. To enter text see page 177.

 →  **Settings** → **Telephony** → **VoIP (Enter system PIN)** → **Provider Registr.**

▶ Change multiple line input:

Username:

Enter the user name (caller ID) for your VoIP provider account. **Username** is often identical to your Internet telephone number (the first part of your SIP address, see page 136).

Authent. Name: / Authent. Password:

Enter the provider-dependent access data that has to be transferred by the phone to the SIP service at registration.

▶ Click **Save** to save the settings.

Setting the phone's IP address in LAN

The base station requires an IP address in order to be "recognised" by the LAN.

The IP address can be assigned to the base station automatically (by the router) or manually.

- ◆ If performed **dynamically**, the router's DHCP server automatically assigns the base station an IP address. The base station's IP address can be changed according to router settings.
- ◆ If performed manually/**statically**, you assign the base station a static IP address. This may be necessary depending on your network configuration.

Please note:

- For how to make the local network settings on the Web configurator, turn to page 130.
- To assign the IP address dynamically, the DHCP server on the router must be activated. Please also read the user guide for your router.

 →  Settings → Base → Local Network

 Enter the system PIN and press **OK**.

▶ Change multiple line input:

IP Address Type:

Select **Static** or **Dynamic**.

If you select **Static**, you must manually define the IP address and the subnet mask for the base station in the next lines, as well as the standard gateway and DNS server.

IP Address:

For **IP Address Type = Dynamic**:

The IP address that is currently assigned to the base station will be displayed. It cannot be amended.

For **IP Address Type = Static**:

Enter the IP address that is to be assigned to the base station (overwriting the current settings).

192.168.2.2 has been preset.

For the IP address see also page 194.

Subnet Mask:

For **IP Address Type = Dynamic**:

The subnet mask that is currently assigned to the base station will be displayed. It cannot be amended.

For **IP Address Type = Static**:

Enter the subnet mask that is to be assigned to the base station (overwriting the current settings).

The default setting is 255.255.255.0

For the subnet mask see also page 199.

DNS Server:**For IP Address Type = Static:**

Enter the IP address for the preferred DNS server. The DNS server (Domain Name System) converts the symbolic name of a server (DNS name) into the public IP address for the server when the connection is made.

You can specify your router's IP address here. The router forwards phone address requests to its DNS server.

192.168.2.1 has been preset.

Default Gateway:**For IP Address Type = Static:**

Enter the IP address for the standard gateway, by means of which the local network is connected with the Internet. This is generally the local (private) IP address for your router (e.g. 192.168.2.1). Your phone requires this information to be able to access the Internet.

192.168.2.1 has been preset.

- Click **Save** to save the settings.

Please note:

You can find notes on the IP address and the subnet mask on page 130 and in the glossary on page 194/page 199.

Activating/deactivating display of VoIP status messages

If the function is activated, a VoIP status code for your service provider is displayed.

Activate the function if, for example, you have problems with VoIP connections. You will receive a provider-specific status code, which supports the service when the problem is analysed. You will find a table with the possible status screens in the appendix (page 168).

 →  **Settings** →  **Telephony** →  **VoIP**

 Enter the system PIN and press **OK**.

Show Stat. on HS

Select and press **OK** (= on).

Please note:

For how to make the setting on the Web configurator, see page 162.

Checking the base station MAC address

Depending on your network configuration, you may have to enter your base station MAC address, for example, into your router's access control list. You can check your base station MAC address:

 **5**  **5**  **9**  **2**  **0**  **+**

The base station MAC address is displayed.

 Press and **hold** (idle status).

Operating the base station on the PABX

The following settings are only necessary when your PABX requires them; see the PABX user guide. The settings only concern fixed line network connections.

You cannot send or receive SMS messages on PABXs that do not support Calling Line Identification.

Changing the dialling mode

You can set the dialling mode.

 →  **Settings** → **Telephony** → **Fixed Line** → **Dialling Mode**

Tone / Pulse / Tone-Earth

Select and press **OK** (= on).



Press and hold (idle status).

Please note:

- Suffix dialling (for selecting the connection) is not possible in conjunction with pulse dialling: a hash "#" is displayed during dialling but ignored when pulse dialling is used.
- Enter an asterisk "*" to switch temporarily to tone dialling. The asterisk is not displayed.

Setting recall

You can set the recall option.

 →  **Settings** → **Telephony** → **Fixed Line** → **Recall**



Select recall and press **OK**.

The current setting is indicated by .



Press and **hold** (idle status).

Setting pauses

Changing pause after line seizure

You can set the length of the pause inserted between pressing the talk key  and sending the phone number.



Enter a number for the length of the pause (1 = 1 sec.; 2 = 3 sec.; 3 = 7 sec.) and press **OK**.

Changing the pause after the recall key

You can change the length of the pause if your PABX requires this (refer to the user guide for your PABX).



Enter a number for the length of the pause (1 = 1 sec.; 2 = 2 sec.; 3 = 3 sec.; 4 = 6 sec.) and press **OK**.

Switching temporarily to touch tone dialling (DTMF)

If your PABX still operates with dial pulsing (DP), but you need touch tone dialling for a connection (e.g. to listen to the network mailbox for your fixed line network) you must switch to touch tone dialling for the call.

Precondition: You are currently conducting an external call via the fixed line network or you have dialled an external fixed line network number or an external call is signalled.

Options Open menu.

Tone Dialing Select and press **OK**.

Touch tone dialling is now activated **for this call only**.

Web configurator – configuring the telephone via a PC

The Web configurator is the Web interface for your phone. It allows you to make the settings for your phone's base station via your PC's Web browser.

Please note:

Depending on your VoIP provider, it is possible that you will be unable to change individual settings in the Web configurator.

Preconditions:

- ◆ A standard Web browser is installed on the PC, e.g. Internet Explorer version 6.0 or higher, or Firefox version 1.0.4 or higher.
- ◆ The phone and PC are connected with each other via a router.

Please note:

- The phone is **not** blocked while you make your settings in the Web configurator. You can also use your phone to make calls or change base station or handset settings on your handset at the same time.
- While you are connected to the Web configurator, it is blocked to other users. It cannot be accessed by more than one user at any time.

With the Web configurator on your phone you have the following options:

- ◆ Configure your phone access to the local network (IP address, gateway to the Internet).
- ◆ Configure your phone for VoIP. Assign up to six VoIP phone numbers to your telephone.
- ◆ Load new firmware onto the phone if necessary.
- ◆ Use internet services: Enable access to an online directory, display text information on the handset (info services) and synchronise the telephone's date/time with a time server on the Internet.
- ◆ Manage the names and internal numbers of registered handsets and your local directories.
- ◆ Obtain information about your phone's status (firmware version, MAC address, etc.).

Connect the PC with the telephone's Web configurator

Precondition: The settings of a firewall installed on your PC allow the PC and phone to communicate with each other.

There are two ways of connecting your PC to the base station Web configurator:

- ◆ via the (local) IP address of the base station
- ◆ via Gigaset config

Establishing a connection via the IP address:

- ▶ Establish the telephone's current IP address on the handset:

You can see the phone's current IP address in the handset display by **briefly** pressing the paging key on the base station.

Your phone's IP address can change if you have activated dynamic IP address assignment (page 130).

- ▶ Launch the Web browser on your PC.
- ▶ Enter **http://** and the telephone's current IP address (for example: <http://192.168.2.2>) into the address field of the Web browser.
- ▶ Press the return key.

A connection is established to the phone's Web configurator.

Establish a connection via Gigaset config:

Precondition: The router is connected to the Internet and your PC can access the Internet via the router.

- ▶ Launch the Web browser on your PC.
- ▶ Enter the following URL into the Web browser's address field:
<http://www.Gigaset-config.com>
- ▶ Press the return key.

You will receive a message stating the connection will be forwarded to your base station. If several Gigaset VoIP phones can be reached via your Internet connection, you will be asked to which one of these phones you would like to be forwarded.

After successfully forwarding the connection, the **Login** Web page will be displayed in the Web browser of the Web configurator.

Please note:

The connection between the PC and the Web configurator is a local connection (LAN connection). The Internet is only accessed to establish the connection.

Logging in, setting the Web configurator language

Once you have successfully established the connection, the **Login** Web page will be displayed in the Web browser.

You can select the language you want the menus and Web configurator dialogues to be displayed in. The language that is currently selected is displayed in the top field of the Web page.

- ▶ If necessary, click to open the list of available languages.
- ▶ Select the language.
- ▶ In the bottom field of the Web page, enter your phone's system PIN (default setting: 0000) to access the Web configurator functions.
- ▶ Click **OK**.

Once you have successfully logged in, a **Home** screen opens with general information on the Web configurator.

Please note:

- If you have forgotten your system PIN, you must restore your device's factory settings. Please note that this will restore all other settings too (page 115).
- If you do not make any entries for a lengthy period (around 10 minutes), you will be automatically logged off. The next time you try to make an entry or open a Web page, the **Login** Web page will be displayed. Enter the system PIN again to log in again.
- Any entries that you did not save on the phone before automatic log-off will be lost.

Logging off

Logging off

In the menu bar (page 127) at the top right of every Web page in the Web configurator, you will see the **Log Off** command. Click **Log Off** to log off from the Web configurator.

Warning:

Always use the **Log Off** command to end the connection to the Web configurator. If, for example, you close the Web browser without logging off beforehand, it is possible that access to the Web configurator will be blocked for a few minutes.

Structure of the Web pages

The Web pages contain the UI elements displayed in Figure 2.

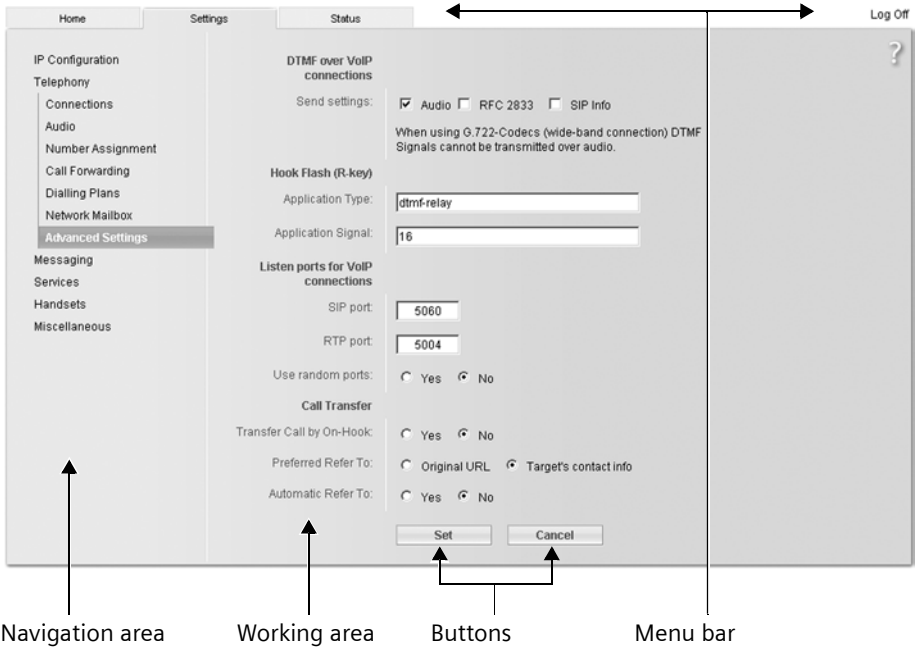

Figure 2 Example of the structure of a Web page

Menu bar

In the menu bar, the Web configurator menus are offered in the form of tab pages.

The following menus are available:

◆ **Home**

The start screen is opened once you have registered with the Web configurator. It contains information on the Web configurator functions.

◆ **Settings** (page 129)

This menu allows you to make settings on your phone.

◆ **Status** (page 162)

This menu gives you information about your phone.

If you click the **Settings** menu, a list with this menu's functions is displayed in the navigation area (page 127).

You will find the **Log Off** function to the right of the menu bar on every Web page (page 126).

Please note:

You will find an overview of the Web configurator menu on page 29.

Navigation area

In the navigation area, the functions of the menu selected in the menu bar (page 127) are listed.

If you click a function, the associated page opens in the working area with information and/or fields for your inputs.

If a function is assigned subfunctions, these are displayed with the function as soon as you click the function. The relevant page for the first subfunction is displayed in the working area.

Working area

Depending on the function selected, information or dialogue boxes are displayed in the working area, which allow you to make or change your phone settings.

Making changes

Make settings for entry fields, lists or options.

- ◆ There may be restrictions regarding the possible values for a field, e.g. entering special characters or certain value ranges.
- ◆ To open a list, click . You can choose between default values.
- ◆ There are two kinds of options:
 - Options in a list, from which you can activate one or several options. Active, i.e. selected options are highlighted with , non-active options with . You can activate an option by clicking . The status of the other options in the list does not change. You can deactivate an option by clicking .

Opening Web pages

- Alternative options. The active option in the list is highlighted with , and the non-active option with . You can activate an option by clicking . The previously activated option is deactivated. You can only deactivate an option by activating another option.

Applying changes

As soon as you have made your change on a page, activate the new setting on the phone by clicking **Set**.

If your input in a field does not comply with the rules for this field, an appropriate error message will be displayed. You can then repeat the input.

Warning:

Changes that have not been saved on your phone are lost if you move to another Web page or if the Web configurator is terminated, e.g. due to the time limit (page 125).

Buttons

Buttons are displayed in the bottom section of the working area.

Set

Save entries on the phone.

Cancel

Reject changes made on the Web page and reload the settings that are currently saved in your phone to the Web page.

Opening Web pages

A brief outline of the navigation to the individual Web configurator functions is given below.

Example:

Setting DTMF signalling

Settings → **Telephony** → **Advanced Settings**

To open the Web page, carry out the following steps after registration:

- ▶ Click the **Settings** menu in the menu bar.
- ▶ Click the **Telephony** function in the navigation area.
 - The subfunctions of **Telephony** are displayed in the navigation tree.
- ▶ Click the **Advanced Settings** subfunction.

The Web page from Figure 2 will be shown in the Web browser.

Setting phone with Web configurator

You can make the following settings using the Web configurator:

- ◆ Connecting your phone to the local network (page 130)
- ◆ Configuring for telephony
 - Enter settings for the VoIP provider and configure or activate/deactivate VoIP accounts (page 133)
 - Specify the name of the fixed line network (page 139)
 - Activate/deactivate the Gigaset.net connection (page 140)
 - Activate/deactivate call forwarding for calls to your VoIP numbers or to your Gigaset.net number (page 146)
 - Configure settings to improve voice quality for the VoIP connections (page 140)
 - Define the default connection for your telephone (fixed line network or VoIP) (page 144)
 - Assign VoIP phone numbers to individual handsets and the answer machine (page 144)
 - Define user-specific dialling plans for emergency numbers and for cost control purposes (page 149)
 - Enter and activate/deactivate the network mailbox for each number assigned to the telephone (page 151)
 - Define the type of DTMF signalling (e.g. for remote operation of a VoIP network mailbox) and the recall key function for VoIP (page 146)
 - Enter settings for call forwarding via VoIP (call placing, i.e. connecting two external callers to each other, page 148)
- ◆ Output of information from an IP info service on the handset (page 155)
- ◆ Synchronisation of date and time on the base station with a time server on the Internet (page 161)
- ◆ Starting firmware updates (page 159)
- ◆ Managing registered handsets
 - Change names and internal numbers of the handsets (page 156)
 - Copy contacts from your PC's Outlook address book to the handset directories or save handset directories to your PC (page 157)
 - Activate/deactivate the display of VoIP status messages on your handset (page 159)

IP Configuration

Assigning the IP address

Make the necessary settings for operating your phone in your local network and to connect it to the Internet. For more detailed explanations of the individual components/terms, see the glossary (page 189).

- ▶ Open the following Web page: **Settings** → **IP Configuration**.
- ▶ In the **Address Assignment** area, select the **IP address type**.

Select **Obtained automatically** if you want your phone to be assigned a dynamic IP address by a DHCP server in your local network. No further settings are necessary for the local network.

Select **Static** if you would like to set up a static IP address for your phone. A static IP address is useful, for example, if port forwarding or a DMZ is set up on the router for the phone.

The following fields are displayed when you select **IP address type = Static**:

IP address

Enter an IP address for your phone. This IP address allows your phone to be reached by other subscribers in your local network (e.g. PC).

192.168.2.2 has been preset.

Please note the following:

- The IP address must be from the address block for private use that is used in the router. This is generally in the range 192.168.0.1 – 192.168.255.254 with **Subnet mask** 255.255.255.0. The subnet mask determines that the first three parts of the IP address must be identical for all subscribers in your LAN.
- The static IP address must not belong to the address block (IP pool range) that is reserved for the DHCP server of the router. It must also not be used by another device on the router.

If necessary, check the settings on the router.

Subnet mask

Enter the subnet mask for your device's IP address. For addresses from the address block 192.168.0.1 – 192.168.255.254, the subnet mask 255.255.255.0 is generally used.

This is preconfigured when the phone is supplied.

Default gateway

Enter the IP address for the standard gateway, by means of which the local network is connected with the Internet. This is generally the local (private) IP address for your router (e.g. 192.168.2.1). Your phone requires this information to be able to access the Internet.

192.168.2.1 has been preset.

Preferred DNS server

Enter the IP address for the preferred DNS server. DNS (Domain Name System) allows you to assign public IP addresses to symbolic names. The DNS server is required to convert the DNS name into the IP address when connection is being established to a server. You can specify your router's IP address here. The router forwards phone address requests to its DNS server.

192.168.2.1 has been preset.

Alternate DNS server (optional)

Enter the IP address for the alternative DNS server that should be used in situations where the preferred DNS server cannot be reached.

Click **Set** to save the changes.

Click **Cancel** to reject the changes.

Allowing access from other networks

The default setting for your phone is set such that you can only access your phone's Web configurator via a PC that is in the same local network as your phone. The subnet mask of the PC must match that of the phone.

You can also allow access from PCs in other networks.

Warning:

Expansion of access entitlement to other networks increases the risk of unauthorised access. It is therefore recommended that you deactivate remote access again if you no longer require it.

- ▶ Open the following Web page: **Settings** → **IP Configuration**.
- ▶ In the **Remote Management** area, activate the **Yes** option to permit access from other networks.
To deactivate remote access, click **No**. Access is then limited to PCs in your own local network.

Access to the Web configurator services from other networks is only possible if your router is set accordingly. The router must pass on the service requests from "outside" to Port 80 (default port) of the phone. Please also read the user guide for your router.

To establish a connection, the public IP address or the DNS name of the router and, where applicable, the port number on the router must be indicated in the Web browser of the remote PC.

Configuring telephone connections

You can configure up to eight numbers on your phone: your fixed line network number, your Gigaset.net number and six VoIP numbers.

You need to set up a VoIP account with a VoIP provider for each VoIP phone number. You must save the access data for each account and for the relevant VoIP provider in the phone. You can assign a name to each connection (VoIP and fixed line network).

To configure the connections:

► Open the following Web page: **Settings** → **Telephony** → **Connections**.

A list (see Figure 3) will be shown with all possible connections that you can configure, or have already configured, for your phone.

IP Connection				
	Name / Provider	Suffix	Status	Active
1.	Anna IP Sipgate	#1	registered	<input checked="" type="checkbox"/>
2.	Michael IP Sipgate	#2	registered	<input checked="" type="checkbox"/>
3.	IP3 Other Provider	#3	Disabled	<input type="checkbox"/>
4.	IP4 Other Provider	#4	Disabled	<input type="checkbox"/>
5.	IP5 Other Provider	#5	Disabled	<input type="checkbox"/>
6.	IP6 Other Provider	#6	Disabled	<input type="checkbox"/>
Gigaset.net				
	Name	Suffix	Status	Active
	Gigaset.net	#9	registered	<input checked="" type="checkbox"/>
Fixed Line Connection				
	Name	Suffix		
	Fixed Line	#0		<input type="checkbox"/>

Figure 3 List of possible connections

The list will show the following:

Name / Provider

Name of the connection. This will show the name that you have defined for the connection (page 134, page 139) or the default name (IP1 to IP6 for VoIP connections, **Fixed Line** for the fixed line network connection and **Gigaset.net**).

VoIP connections also display the name of the VoIP provider with which you have opened the account. If the name is unknown the display will show **Other Provider**.

Suffix

Line suffix that you have to add to the phone number of an outgoing call to allow the account assigned to the suffix to be used as the sending account.

Example: if you dial 123456765#1, the connection will be made and billed through the first VoIP account, regardless of the number you have assigned to your handset as the send number and whether you press briefly/press and hold the talk key.

If you dial 123456765#0, the connection will be made via the fixed line network.

Status

The status of the connection will be shown for VoIP connections:

Registered

The connection is activated. The phone has been successfully registered. You can use the connection to make calls.

Disabled

The connection is deactivated. The phone is not registering with the corresponding account with the VoIP service. You cannot use the connection to make or receive calls.

Registration failed / Server not accessible

Your phone was unable to register with the VoIP service, e.g. because the VoIP access data is incorrect or incomplete or the phone is not connected to the Internet. There is information about this in the section "Questions and answers" from page 163 onwards.

Active

You can use the option in the **Active** column to activate () and deactivate () VoIP connections. If a connection is deactivated, the phone will not register for this connection. The connection can be activated/deactivated by clicking directly on the option. The change does not need to be saved.

To configure a connection or to change the configuration of a connection:

- ▶ Click **Edit** next to the connection.

This will open a Web page where you can make the settings needed. More information is available

- ◆ in the section "Configuring the VoIP connection" on page 133 and
- ◆ in the section "Configuring the fixed line connection" on page 139.

Configuring the VoIP connection

Open the Web page:

- ▶ Open the following Web page: **Settings** → **Telephony** → **Connections**.
- ▶ Click **Edit** next to the VoIP connection that you want to configure or the configuration of which you want to change.

This will open a Web page where you can make the settings that your phone needs to access your provider's VoIP server.

The Web page always displays the following areas:

- ◆ **IP Connection** (page 134),
- ◆ **Auto Configuration** (page 134),
- ◆ **Personal Provider Data** (page 136).

Configuring telephone connections

The areas

- ◆ **General Provider Data** (page 136) and
- ◆ **Network** (page 137)

can be shown and hidden by clicking the **Show Advanced Settings** and **Hide Advanced Settings** buttons.

You must enter the VoIP provider's general access data in these areas. You can download this data for many VoIP providers from the Internet (see "Area: Auto Configuration").

- ▶ Make the settings on the Web page.
- ▶ Save them in the phone, see page 139.
- ▶ Activate the connection if necessary, see page 139.

Area: IP Connection

Connection Name or Number

Enter a name for the VoIP connection or the VoIP phone number (max. 16 characters). This name is used to display the connection on the handset and the Web configurator interface, e.g. during allocation of send and receive numbers (page 144), for the call display (page 34).

Area: Auto Configuration

The entire configuration process or a large part of the configuration for a VoIP connection is automated for many VoIP providers. You can download the necessary VoIP access data to your telephone from the Internet.

You have the following options:

- ◆ Fully automated configuration

Preconditions:

- You have received an **auto configuration code** from your VoIP provider.
- The general access data for your VoIP provider is available for downloading.

You can download all the data required for VoIP access from the Internet:

- ▶ Enter the auto configuration code you received from your VoIP provider in the **Auto Configuration** area in the **Auto Configuration Code** field.
- ▶ Click **Start Auto Configuration**.

The telephone establishes a connection to the Internet and downloads all data required for the VoIP connection, i.e. the general provider information and your personal provider data (account data) are saved to your base station.

If further information is used on the Web page, this is deleted as soon as **Start Auto Configuration** is clicked. The fields in the **Personal Provider Data** and **General Provider Data** areas and the server addresses in the **Network** area are overwritten by the downloaded data.

Generally, you should not have to enter any additional data on this Web page.

Please note:

If the message **Download of settings not possible! File is corrupt!** appears, no data will be loaded onto the phone. Possible causes of this are:

- The incorrect code has been entered (e.g. upper/lower case rules have not been followed). If necessary, enter the code again.
- The file that has been downloaded is invalid. Please consult your VoIP provider.

When the download is complete, the **Connections** list will be displayed.

- ▶ Activate the connection as described under page 139.

You can now be reached on the corresponding VoIP phone number.

◆ Automatic configuration of general VoIP provider data

Precondition: You have received your account details from your VoIP provider (e.g. **Authentication Name**, **Authentication password**).

Profile files of the most important VoIP providers are available on the Siemens Internet server for downloading. The address for the server is stored in your phone (page 159).

Proceed as follows to load the data onto your telephone:

- ▶ In the **Auto Configuration** area, click **Select VoIP Provider**. This will display information on the download procedure.

Please note:

If you click the **Select VoIP Provider** button, any changes that have been made to the Web page will be saved and checked. Values may need to be corrected before the **Select VoIP Provider** operation is started.

The download procedure has several steps:

- ▶ Click **Next**.
- ▶ From the list, select the country for which the list of VoIP providers is to be loaded.
- ▶ Click **Next**.
- ▶ Select your VoIP provider from the list.
If your provider is not included in the list, select **Other Provider**. In this case you will have to enter the general provider data by hand (see "Area: General Provider Data" and "Area: Network" below).
- ▶ Click **Finish**.

The details of the selected provider are loaded to your phone and saved under **General Provider Data** (page 136) and **Network** (page 137). You cannot make any further entries in these areas.

The field **Provider** shows the name of the selected provider or **Other Provider**. A link to the provider's homepage is displayed where available.

To complete configuration of your VoIP connection enter your account data under **Personal Provider Data**.

Configuring telephone connections

Area: Personal Provider Data

Enter the configuration data that is necessary for accessing your VoIP provider's SIP service. You will receive this data from the VoIP provider.

The field names (**Authentication Name** etc.) listed in the following are standard names and may change. If you have already downloaded the provider's general details ("**Select VoIP Provider**" button, see above), field entries will be replaced by provider-specific names to facilitate orientation (e.g. SIP-ID instead of **Authentication Name**).

Authentication Name

Specify the registration or authentication ID agreed with your VoIP provider. The registration ID serves as the access ID that your phone must specify when registering with the SIP proxy/registrar server. The **Authentication Name** is mainly identical to the **Username**, i.e. to your Internet phone number.

Authentication password

Enter the password that you have agreed with your VoIP provider in the **Authentication password** field. The phone needs the password when registering with the SIP proxy/registrar server.

Username

Enter the caller ID for your VoIP provider account. This ID is usually identical to the first part of your SIP address (URI, your Internet phone number).

Example: If your SIP address is "987654321@provider.com", enter "987654321" in **Username**.

Display name (optional)

Enter any name that should be shown in the other caller's display when you call them via the Internet (example: Anna Sand). All characters in the UTF8 character set (Unicode) are permitted. The name must not exceed 32 characters.

If you do not enter a name, your **Username** VoIP phone number will be displayed.

Ask your VoIP provider if this feature is supported.

Area: General Provider Data

If you have downloaded the general settings for the VoIP provider from the Siemens configuration server (page 134), then the fields in this area will be preset with the data from the download. Generally speaking, you do not need to configure any settings in this area.

Domain

Specify the last part of your SIP address (URI) here.

Example: For the SIP address "987654321@provider.com", enter "provider.com" in **Domain**.

Proxy server address

The SIP proxy is your VoIP provider's gateway server. Enter the IP address or the (fully-qualified) DNS name of your SIP proxy server. **Example:** myprovider.com.

Proxy server port

Enter the number of the communication port that the SIP proxy uses to send and receive signalling data (SIP port).

Port 5060 is used by most VoIP providers.

Registrar server

Enter the (fully-qualified) DNS name or the IP address of the registrar server.

The registrar is needed when the phone is registered. It assigns the public IP address/port number to your SIP address (**Username@Domain**) that were used by the phone at registration. With most VoIP providers, the registrar server is identical to the SIP server.

Example: reg.myprovider.com.

Registrar server port

Enter the communication port used in the registrar. It is mainly port 5060 that is used.

Registration refresh time

Enter the time intervals at which the phone should repeat the registration with the VoIP server (SIP proxy) (a request will be sent to establish a session). The repeat is required so that the entry of the phone in the tables of the SIP proxy is retained and the phone can therefore be reached. The repeat will be carried out for all activated VoIP phone numbers.

The default is 180 seconds.

If you enter 0 seconds, the registration will not be repeated periodically.

Area: Network

Please note:

If you have downloaded the general settings for your VoIP provider from the Siemens configuration server (page 133), then some fields in this area will be preset with the data from the download (e.g. the settings for the STUN server and outbound proxy).

If your phone is connected to a router with NAT (Network Address Translation) and/or a firewall, you must make some settings in this area so that your phone can be reached from the Internet (i.e. can be addressed).

Through NAT, the IP addresses of subscribers in the LAN are concealed behind the public IP address of the router.

For incoming calls

If port forwarding is activated or a DMZ is set up for the phone on the router, no special settings are required for incoming calls.

If this is not the case, an entry in the NAT routing table (in the router) is necessary in order for the phone to be reached. This entry is created when the phone is registered with the SIP service. In the interest of security, this entry is automatically deleted at certain intervals (session timeout). The phone must therefore confirm its registration at certain intervals (see **NAT refresh time**, page 138), so that the entry stays in the routing table.

For outgoing calls

The phone needs its public address in order to receive caller voice data.

There are two possibilities:

- ◆ The phone requests the public address from a STUN server on the Internet (Simple Transversal of UDP over NAT). STUN can only be used with asymmetric NATs and non-blocking firewalls.
- ◆ The phone does not direct the connection request to the SIP proxy but to an outbound proxy on the Internet that supplies the data packets along with the public address.

Configuring telephone connections

The STUN server and outbound proxy are used alternately to work around the NAT/firewall in the router.

STUN enabled

Click **Yes** if you want your phone to use STUN as soon as it is used on a router with asymmetric NAT.

STUN server

Enter the (fully-qualified) DNS name or the IP address of the STUN server on the Internet.

If you selected **Yes** in the **STUN enabled** field, you must enter a **STUN server** here.

STUN port

Enter the number of the communication port on the STUN server. The default port is 3478.

STUN refresh time

Enter the time intervals at which the phone should repeat the registration with the STUN server. The repeat is required so that the entry of the phone in the tables of the STUN server is retained. The repeat will be carried out for all activated VoIP phone numbers.

Ask your VoIP provider for the **STUN refresh time**.

The default is 240 seconds.

If you enter 0 seconds, the registration will not be repeated periodically.

NAT refresh time

Specify the intervals at which you want the phone to update its entry in the NAT routing table. Specify an interval in seconds that is a little smaller than the NAT session timeout.

As a rule you should not change the preconfigured value for the **NAT refresh time**.

Outbound proxy mode

Specify when the outbound proxy should be used.

Always

All signalling and voice data sent by the phone is sent to the outbound proxy.

Auto

Data sent by the phone is only sent to the outbound proxy when the phone is connected to a router with symmetric NAT or blocking firewall. If the phone is behind an asymmetric NAT, the STUN server is used.

If you have set **STUN enabled** = **No** or have not entered a STUN server, the outbound proxy is always used.

Never

The outbound proxy is not used.

If you do not make an entry in the **Outbound proxy** field, the phone behaves independently of the selected mode, as with **Never**.

Outbound proxy

Enter the (fully qualified) DNS name or the IP address of your provider's outbound proxy.

Please note:

With many providers, the outbound proxy is identical to the SIP proxy.

Outbound proxy port

Enter the number of the communication port used by the outbound proxy.
The default port is 5060.

Saving settings on the phone

- ▶ Click **Set** to save the changes.

The **Connections** list will be shown after saving (see Figure 3 on page 132).

If you want to reject the changes that have been made, click **Cancel**.

Clicking **Delete** will reset all the values back to their default settings. Fields with default settings are empty.

Please note: If you do not make any entries for a lengthy period, the connection to the Web configurator is automatically terminated. Unsaved entries are lost. If necessary, implement temporary security measures. You can subsequently continue the entry and make changes if necessary.

Activating a new connection

If you have configured a new VoIP connection, you must also activate it.

In the **Connections** list:

- ▶ Activate the relevant option in the **Active** column (= activated).

Your phone will register itself with the VoIP provider using the relevant access data. Update the Web page (e.g. by pressing F5). The **Status Registered** column will appear if registration was successful. You can now be reached on this VoIP phone number.

Please note:

Once the new entry has been made, the VoIP phone number is assigned to each handset and the integrated answer machine (Gigaset C47 IP) is assigned as a receive number. For how to adjust the assignment, see page 144.

Configuring the fixed line connection

You can assign a name to your fixed line connection. This name is used to display the connection on the handset and the Web configurator interface, e.g. during allocation of send and receive numbers (page 144), for the call display (page 34).

- ▶ Open the following Web page: **Settings** → **Telephony** → **Connections**.
- ▶ In the **Fixed Line Connection** area, click **Edit**.
- ▶ Enter your fixed line network number or the name of your choice (max. 16 characters) for your fixed line connection in the **Connection Name or Number** field. The default is "Fixed Line".

Activating/deactivating the Gigaset.net connection

Your phone is assigned a Gigaset.net phone number on delivery. As soon as you have connected your phone to the Internet, you can make calls using the Gigaset.net and receive calls from other Gigaset.net subscribers, provided that your Gigaset.net connection has been activated. You can deactivate the Gigaset.net connection.

- ▶ Open the following Web page: **Settings** → **Telephony** → **Connections**. The list of connections will be displayed (see Figure 3 on page 132).
- ▶ In the **Gigaset.net** area: use the option in the **Active** column to activate () or deactivate () the Gigaset.net connection.

Please note:

If you do not use your Gigaset.net connection for six weeks, it is automatically deactivated. You cannot be reached for calls from the Gigaset.net.

The connection is reactivated:

- as soon as you start a search in the Gigaset.net directory (page 40) or
- make a call via Gigaset.net, i.e. dial a number ending in #9 (two attempts may be necessary) or
- activate the connection via the Web configurator as described above.

Optimising voice quality for VoIP connections

You can make general and connection-specific settings to improve the voice quality for VoIP telephony.

- ▶ Open the following Web page: **Settings** → **Telephony** → **Audio**.

The voice quality for VoIP connections is mainly determined by the **voice codec** used for transferring the data and the available **bandwidth** of your DSL connection.

In the case of the voice codec, the voice data is digitalised (coded / decoded) and compressed. A "better" codec (better voice quality) means more data needs to be transferred, i.e. perfect voice data transfer requires a DSL connection with a larger bandwidth.

The following voice codecs are supported by your phone:

G.722

If you register an HDSP capable handset (HDSP= High Definition Sound Performance) with your base station, the calls you make using the handset via G.722 VoIP connections will have a fantastic sound quality. Gigaset handsets S67H and SL37H, for e.g., are HDSP capable.

The **broadband** speech codec **G.722** works at the same bit rate as G.711 (64 kbit/s per speech connection) but with a higher sampling rate.

G.711 a law / G.711 μ law

Excellent voice quality (comparable with ISDN). The necessary bandwidth is 64 kbit/s per voice connection.

G.726

Good voice quality (inferior to that with G.711 but better than with G.729).

Your phone supports G.726 with a transmission rate of 32 kbit/s per voice connection.

G.729

Average voice quality. The necessary bandwidth is less than 8 kbit/s per voice connection.

Both sides of a phone connection (caller/sender side and receiver side) must use the same voice codec. The voice codec is negotiated between the sender and the recipient when establishing a connection.

You can influence the voice quality by selecting (bearing in mind the bandwidth of your DSL connection) the voice codecs your phone is to use, and specifying the order in which the codecs are to be suggested when a VoIP connection is established.

Area: Settings for Bandwidth

The settings in this area influence all VoIP connections (VoIP phone numbers).

Allow 1 VoIP call only

Generally speaking you can make two VoIP calls at the same time on your phone. If, however, your DSL connection has a narrow bandwidth, there may be problems if two VoIP calls are made at the same time. The data is no longer transferred properly (long voice delay, data losses etc.).

- ▶ Activate **Yes** next to **Allow 1 VoIP call only** to prevent any further parallel VoIP phone connections being established.
- ▶ If you wish to permit two VoIP connections, activate the **No** option.

Please note: If only one VoIP connection is permitted, the following VoIP network services are **no longer** available:

- Call waiting
Call waiting is not displayed during a call via VoIP
- External consultation call from a VoIP call
- Toggling and initiating a conference call via VoIP

Voice Quality

Default settings for the codecs used are stored in your phone: one setting optimised for narrow and one for wide bandwidths.

- ▶ Activate one of the options **Optimized for low bandwidth / Optimized for high bandwidth** if you wish to accept a default setting for all VoIP connections. The settings are shown in the **Settings for Connections** area and cannot be changed.
- ▶ Activate the **Own Codec preference** option if you wish to select and set connection-specific voice codecs yourself (see "Area: Settings for Connections").

Optimising voice quality for VoIP connections

Area: Settings for Connections

In this area you can make specific settings for each of your VoIP phone numbers.

You can make the following settings for each VoIP phone number configured on your phone:

Volume for VoIP Calls

Depending on the VoIP provider, it is possible that the received voice/earpiece volume is too low or too high, so that adjusting the volume via the handset is not adequate.

Specify whether the received volume range is too high or too low. The following options are available:

Low

Voice/earpiece volume is too high. Activate this option to reduce the volume by 6 dB.

Normal

The voice/earpiece volume does not need to be raised/lowered.

High

Voice/earpiece volume is too low. Activate this option to increase the volume by 6 dB.

Voice codecs

Precondition: The **Own Codec preference** option is activated for the **Voice Quality** in the **Settings for Bandwidth** area.

Select the voice codecs your phone is to use, and specify the order in which the codecs are to be suggested when a VoIP connection is established via this VoIP phone number.

- ▶ Apply the voice codecs that your phone is to suggest with outgoing calls into the **Selected codecs** list.
To do this, in the **Available codecs** list click the voice codec that you want to apply (you can mark several entries using the Shift key or the Ctrl key). Click **<Add**.
- ▶ Move the voice codecs that you do not want the phone to use into the **Available codecs** list.
Also, select the voice codecs in the **Selected codecs** list (see above) and click **Remove>**.
- ▶ Sort the voice codecs in the **Selected codecs** list into the order in which they should be suggested to the receiving device when a connection is established. To do this, use the **Up** and **Down** buttons.

When establishing a VoIP connection, the phone suggests the 1st voice codec in the **Selected codecs** list to the receiving device to begin with. If the receiving device does not accept the codec (e.g. because it is not supported), the 2nd voice codec on the list is suggested, and so on.

If the receiving device does not accept any of the voice codecs in the **Selected codecs** list, the connection is **not** established. An appropriate message will be displayed on the handset.

Please note:

- You should only deactivate codecs (put them in the **Available codecs** list) if there is a particular reason. The more codecs that are deactivated, the greater the danger that calls will not be able to be established due to unsuccessful codec negotiations.
- With incoming calls, all supported voice codecs are always permitted.

Area: Settings for Codecs

To save additional bandwidth and transmission capacity, on VoIP connections that use codec **G.729** you can suppress the transmission of voice packets in pauses ("Silence Suppression"). Then, instead of the background noises in your environment, your caller hears a synthetic noise generated in the receiver.

Please note: "Silence Suppression" can sometimes lead to deterioration in the voice quality.

- ▶ In the **Enable Annex B for codec G.729** field, state whether the transmission of data packets during pauses should be suppressed when using the **G.729** codec, (activate **Yes**).

Saving settings on the phone

- ▶ Click **Set** to save the settings for the voice quality.

Please note:

You should observe the following for good voice quality:

- When making calls using VoIP, avoid performing other Internet activities (e.g. surfing the Internet).
- Irrespective of the codec used and the network capacity utilisation, please note that voice delays can occur.

Voice quality and infrastructure

A Gigaset C470 IP or C475 IP will allow you to make calls with good voice quality via the Internet.

However, your phone's performance with VoIP – and therefore the voice quality – also depends on the properties of the entire infrastructure.

The following VoIP provider components are just some of the things that can influence performance :

- ◆ Router
- ◆ DSLAM
- ◆ DSL transmission line and speed
- ◆ Connection paths over the Internet
- ◆ If necessary, other applications that also use the DSL connection

In VoIP networks, voice quality is affected by various things including the "quality of service" (QoS). If the entire infrastructure demonstrates QoS, voice quality is better (fewer delays, less echoing, less crackling etc.).

If, for example, the router does not have QoS, then the voice quality is not as good. Please see the specialist documentation for further information.

Setting the telephone default connection

The default telephone connection defines which line type (VoIP or fixed line network) will be used to dial numbers when you **briefly** press the  key. The default connection is applied to all registered handsets.

- ▶ Open the following Web page: **Settings** → **Telephony** → **Number Assignment**.
- ▶ Enter the default connection in the **Linetype for outgoing calls** area. This can be done by clicking on the **VoIP** or **Fixed Line** option.
- ▶ Now click **Set** to activate your settings.

Please note:

- The default connection is only relevant when dialling numbers that are not subject to dialling plans and are entered without a line suffix.
- You can change the settings for the default connection via any registered handset (page 116).

Assigning send and receive numbers to handsets

You can assign up to eight numbers on your phone: your fixed line network number, your Gigaset.net number and six VoIP numbers.

You can assign as many of these numbers as you like to each handset as receive numbers. Receive numbers determine which handset(s) will ring when a call is received.

You can assign one of your VoIP numbers to each handset as a (VoIP) send number. Send numbers define which VoIP account should be used in general to make and pay for outgoing VoIP calls. **Exceptions:**

- ◆ a phone number is dialled with a line suffix (page 133) or
- ◆ a dialling plan has been defined for the phone number (page 149).

The Gigaset.net number and fixed line network number are permanently assigned to each registered handset as send numbers.

Please note:

A handset is assigned the following numbers after it is registered on the base station:

- Receive numbers: all phone numbers assigned to the phone (fixed line network, Gigaset.net and VoIP).
- Send numbers: the fixed line network number and the VoIP phone number that you entered at the start of the phone configuration.

- ▶ Open the following Web page: **Settings** → **Telephony** → **Number Assignment**.

The display shows all registered handsets. A list is displayed for each handset showing the phone numbers that are configured and activated for the phone. The connection names are shown in the **Connections** column. The fixed line network connection is always at the end of the list.

- ▶ Define a VoIP phone number as the send number for each handset. To do this, click the option following the phone number in the **for outgoing calls** column. The previous assignment will automatically be deactivated.

Please note:

The fixed line network number is permanently assigned to each handset as a send number. This assignment cannot be deactivated. It ensures that emergency calls can be made from every handset.

The Gigaset.net number is also permanently assigned to each handset.

- ▶ Select the phone numbers for each handset (fixed line network, VoIP) that are to be assigned to the handset as receive numbers. To do this, click the option following the phone number in the **for incoming calls** column. Every handset can be assigned several phone numbers or no phone number (= assigned).
- ▶ Now click **Set** to save your settings.

Please note:

- If a VoIP phone number that has been assigned to a handset as a send number is deleted, then the handset will automatically be assigned the first configured VoIP phone number.
- Calls made to a number that is not assigned to a handset as a receive number will not be signalled on any handset.
- If you have not assigned receive numbers to any of the handsets, calls to all connections will be signalled on all handsets.

Assigning answer machine receive numbers (Gigaset C475 IP)

You can specify for which of your phone numbers your telephone's answer machine is to accept the calls. To do this, assign receive numbers to the answer machine.

Please note:

- Once the new entry has been made, each VoIP phone number is assigned to the integrated answer machine as a receive number.
- If no receive number is assigned to the answer machine it will not accept any calls even if it is activated.
- For how to set and operate the answer machine, see page 71.

- ▶ Open the following Web page: **Settings** → **Telephony** → **Number Assignment**.
- ▶ In the **Answering machine** area, select the phone numbers (fixed line network, VoIP) for which the answer machine is to accept calls (if it is activated, see page 71). To do this, click the option following the phone number in the **for incoming calls** column. You can assign as many numbers as you wish to the answer machine (= assigned).
- ▶ Now click **Set** to save your settings.

Call Forwarding to activate VoIP connections

You can forward calls to your VoIP numbers and to your Gigaset.net number.

You can forward calls to your VoIP numbers to any external number (VoIP, fixed line network or mobile network number). The forwarding is done via a VoIP connection.

You can forward calls to your Gigaset.net number within the Gigaset.net, i.e. to another Gigaset.net number.

You can define if and when calls to your Gigaset.net number and some of your VoIP numbers (VoIP account) should be forwarded to this VoIP number.

You can also use the handset to define call forwarding and activate/deactivate it, see page 47.

▶ Open the following Web page: **Settings** → **Telephony** → **Call Forwarding**.

The display shows a list of all your VoIP connections and your Gigaset.net number.

Connections

Select the name you have assigned to the VoIP number, or select **Gigaset.net**.

When

Select when a call to this VoIP number should be forwarded: **When busy / No reply / Always**.

Select **Off** to deactivate call forwarding.

Call number

Enter the phone number to which the calls should be forwarded. Please note that you may have to enter the area code when forwarding to a fixed line network number in the same area (depending on your VoIP provider and the setting for the automatic area code, see page 148).

The settings only affect the selected phone number.

Please note:

For how to forward your fixed line network number, see page 45.

Setting DTMF signalling for VoIP

DTMF signalling is required, for example, for querying and controlling certain network mailboxes via digit codes or for remote operation of the integrated answer machine (Gigaset C475 IP).

To send DTMF signals via VoIP you must first define how key codes should be converted into and sent as DTMF signals: as audible information via the speech channel or as "SIP Info" message.

Ask your VoIP provider which type of DTMF transmission it supports.

▶ Open the following Web page: **Settings** → **Telephony** → **Advanced Settings**.

In the **DTMF over VoIP connections** area, make the required settings for sending DTMF signals.

▶ Activate **Audio** or **RFC 2833**, if DTMF signals are to be transmitted acoustically (in voice packets).

▶ Activate **SIP Info** if DTMF signals are to be transmitted as code.

▶ Now click **Set** to save your settings.

Please note:

The settings for DTMF signalling apply to all VoIP connections (VoIP accounts).

Defining recall key functions for VoIP (hook flash)

Your VoIP provider may support special performance features. To make use of these features, your phone needs to send a specific signal (data packet) to the SIP server. You can assign this "signal" to your phone's recall key.

If you press the recall key during a VoIP call the signal will be sent to the server.

- ▶ Open the following Web page: **Settings** → **Telephony** → **Advanced Settings**.
- ▶ Enter the data you received from your VoIP provider into the fields **Application Type** and **Application Signal** in the **Hook Flash (R-key)** area.
- ▶ Now click **Set** to save your settings.

The setting for the recall key applies to all registered handsets.

Defining local communication ports for VoIP

- ▶ Open the following Web page: **Settings** → **Telephony** → **Advanced Settings**.

In the **Listen ports for VoIP connections** area, specify which local ports the telephone is to use for VoIP telephony. The ports must not be used by any other subscriber in the LAN.

SIP port

Specify the local communication port that the phone should use to send and receive signalling data. Specify a number between 1024 and 49152. The default port number for SIP signalling is 5060.

RTP port

Specify the local communication port that the phone should use to receive voice data. Enter an **even** number between 1024 and 49152. The port number must **not** be the same as the port number in the **SIP port** field. If you enter an odd number, the next lowest even number will be selected automatically (e.g. you enter 5003, then 5002 is set automatically). The default port number for voice transmission is 5004.

Use random ports

Click **Yes** if you do not want the phone to use fixed ports for **SIP port** and **RTP port**, but rather to use any free ports.

The use of random ports makes sense if you want several phones to be operated on the same router with NAT. The phones must then use different ports so that the router's NAT is only able to forward incoming calls and voice data to one (the intended) phone.

If you click **No**, the phone will use the ports specified in **SIP port** and **RTP port**.

- ▶ Now click **Set** to save your settings.

Configuring call forwarding via VoIP

If you are toggling calls via VoIP connections, you can connect the two external callers (provider-dependent). You can configure settings for this type of call forwarding.

- ▶ Open the following Web page: **Settings** → **Telephony** → **Advanced Settings**.
- ▶ Configure the following settings in the **Call Transfer** area for call forwarding via VoIP:

Transfer Call by On-Hook

If you activate **Yes**, the external parties you are toggling between will be connected when you press the end call key . Your connections with the parties will be terminated.

To learn how to forward a call when you have activated **No**, please see page 48.

Preferred Refer To

Define the protocol (the contents of the "Refer To" information) that should be used with preference when forwarding calls:

Target's contact info

This protocol is recommended for "closed" networks (internal company and business networks).

Original URL

This protocol is recommended when the base station is connected to the Internet via a router with NAT.

Automatic Refer To

If you activate **Yes**, the base station will attempt to determine the best protocol automatically.

If the base station cannot determine the best protocol, it will use the protocol defined in **Preferred Refer To**.

- ▶ Now click **Set** to save your settings.

Setting area code predialling

On the base station, save the complete code (with international code) for the area in which you are using the phone.

For VoIP calls you must generally always dial the area code – even for local calls. You can save the need to dial the area code for local calls by setting your phone to prefix this code for all VoIP calls made in the same local area.

For calls made via VoIP, the area code entered is then prefixed to all numbers that do not start with 0 – even when dialling numbers from the directory and other lists. **Exceptions:** Numbers for which you have defined dialling plans (page 149).

- ▶ Open the following Web page: **Settings** → **Telephony** → **Dialling Plans**.

Configure the following settings in the **Area Codes** area:

- ▶ From the **Country** list, select the country in which you are using your phone. This way the country code and the prefix of the area code are automatically set (in **International Prefix / Area Code** and **Local Prefix** fields).

- ▶ In the **Local Area Code** field enter the area code for your town without a prefix, e.g. 20 (for London).
- ▶ Click **Yes** next to **Predial area code for local calls through VoIP** to activate the function.
Click **No** to deactivate the function. You will then need to enter the area code for local calls made via VoIP. Numbers in the directory must always contain the area code for dialling via VoIP.
- ▶ Click **Set** to save the settings.

Please note:

- ◆ The area code will also be prefixed to VoIP calls made to emergency numbers if there are **no** defined dialling plans for these numbers.
- ◆ The numbers of your network mailbox saved in the base station are **not** prefixed with a code (page 151).

Defining dialling plans – cost control

You can define dialling plans to reduce costs:

- ◆ You can define the connection (one of your VoIP accounts, the fixed line network) through which calls to specific numbers should be made and paid for.
If you enter just a few digits (e.g. local area, national or mobile network code) any call to a number beginning with these digits will be made via the elected connection.
- ◆ You can block specific numbers, i.e. your phone will not establish a connection to these numbers (e.g. 0900 numbers).

These dialling plans apply to all registered handsets. The settings for the default connection (briefly press/press and hold ) and the send numbers of handsets do not apply to numbers governed by a dialling plan.

Please note:

You can override dialling plans, with the exception of blocks, as follows:

- Dial the number with a line suffix (e.g. 123456789#3, see page 31).
- Before you enter the number, define a different connection type by pressing the display keys **FixedLine** / **IP** (page 108).

If, for example, you press **FixedLine**, the number will be dialled via the fixed line network, even if the dialling plan states that a VoIP connection should be used.

Area code predialling is not prefixed to numbers governed by a dialling plan (page 148).

Tips:

- ◆ Compare the rates for long-distance calls (especially for international calls) offered by your fixed line network and VoIP providers, and determine which connection should be used specifically for these countries/locations, e.g. a dialling plan for the **Phone Number** "0033" would apply to every call made to France.
- ◆ Use dialling plans to define that numbers starting with a call-by-call number are always made via your fixed line network connection. To do so, enter the call-by-call number in the **Phone Number** field.

Defining dialling plans

- ▶ Open the following Web page: **Settings** → **Telephony** → **Dialling Plans**.

You can define dialling plans for your telephone in the **Dialling Plans** area. Specify the following:

Phone Number

Enter the number or the first digits of the phone number (e.g. an area code) to which the dialling plan should apply (max. 15 digits).

Enter each phone number and the area code, even if you have activated the **Predial area code for local calls through VoIP** (page 148) function.

Connection Type

The list shows all the VoIP connections that you have configured as well as your fixed line network connection. It also displays the name assigned to each connection.

- ▶ From the list, select the connection via which the number or numbers that start with the sequence of digits should be dialled.

Or:

- ▶ Select **Block** if the number or numbers that start with the sequence of digits should be blocked.

The display will show **Not possible!** if an attempt is made to dial a blocked number.

Comment (optional)

You can enter a description of up to 20 characters for the dialling plan here.

- ▶ Click **Add**.

The dialling plan is activated immediately.

A new empty line for a new dialling plan will appear if your phone still has enough space.

Please note:

If dialling plans overlap, the one with the greatest concordance will apply.

Example: There is a dialling plan for the number "02" and one for the number "023". If you dial "0231 ..." the second rule will apply; if you dial "0208..." the first rule will apply.

Examples:

- ◆ You want to block your phone for all 0900 numbers.

Dialling plan:

Phone Number = 0900 **Connection Type** = **Block**

- ◆ All calls to the mobile phone network shall be made via your VoIP connection with provider B.

Dialling plans:

Phone Number = 017 **Connection Type** = **IP3**, provider B

and the corresponding entries for "015" and "016".

Activating/deactivating dialling plans

- ▶ Click the option in the **Active** column to activate/deactivate the corresponding dialling plan (= activated).

A deactivated dialling plan will not take effect until it is reactivated.

Deleting dialling plans

- ▶ Click **Delete** next to the dialling plan you wish to delete.

The dialling plan is deleted from the list immediately. The space in the list is released.

Please note:

Predefined dialling plans set as defaults (for emergency numbers **cannot** be deactivated and **cannot** be deleted).

Emergency numbers

Dialling plans for emergency numbers (e.g. the **local** emergency service number) are factory-set for certain countries. The fixed line network is determined as the **Connection Type**. These dialling plans cannot be deleted, deactivated or blocked. However, you can change the **Connection Type**.

This should only be changed if the phone is not connected to the fixed line network. If you choose a VoIP connection, please make sure the VoIP provider supports emergency calls.

If no emergency numbers are set by default, you should define dialling plans for emergency numbers yourself and assign them to a connection of which you know that it supports emergency calls. Emergency calls are always supported by fixed line networks.

Warning:

- Emergency numbers cannot be dialled if the keypad lock is activated. Before dialling, press **and hold** the hash key () to release the keypad lock.
- If you have activated an automatic area code (page 148) and if no dialling plan for emergency calls is defined, the area code will also be prefixed to emergency calls made via VoIP.

Activating/deactivating network mailbox, entering numbers

Many fixed network providers and VoIP providers offer answer machines on the network – these are known as network mailboxes.

Each network mailbox accepts incoming calls made via the corresponding line (fixed line network or corresponding VoIP phone number).

You can enter the relevant network mailbox for each configured connection (VoIP, fixed line network) via the Web configurator. You can activate or deactivate the network mailbox for your VoIP connections.

- ▶ Open the following Web page
Settings → **Telephony** → **Network Mailbox**.

A list with all possible connections is displayed on the Web page. The names of the connections are displayed in the **Connection** column.

Saving messenger access data

Entering numbers

- ▶ Enter the network mailbox number in the **Call number** column after the desired connection.

With some VoIP providers your mailbox number will be downloaded together with the general VoIP provider data (page 135), saved to your base station and displayed under **Call number**.

- ▶ Now click **Set** to save your settings.

Activating/deactivating the network answer machine

- ▶ You can activate () and deactivate () individual network mailboxes using the option in the **Active** column. Activating/deactivating is carried out by clicking on the appropriate option. The change does not need to be saved.

Please note:

- You need to have **requested** the network mailbox for your fixed line network connection from your fixed line network provider.
- You can read how to enter the network mailbox numbers and activate/deactivate network mailboxes on page 94.

Saving messenger access data

The messenger client in your base station enables **instant messaging** (immediate message transfer, chatting). The phone supports the XMPP messenger (Jabber).

In order for you to use your phone's messenger to "go online" and "chat" on the Internet, the access data of a messenger server must be saved on your phone.

Your phone is already registered with the Gigaset.net Jabber server. An account has been assigned to your phone. You can chat to other Gigaset.net subscribers via this account. To do this you need to create a buddy list on the PC (see "Setting up Gigaset.net Jabber account" on page 153).

You can also register with another instant messaging provider that supports XMPP Messenger (Jabber). You must then save the messenger server address and your access data on your phone.

You can define a **Resource** name and a **Priority** for your phone. Both are required if you are logged in (online) with the messenger server with several devices (phone, desktop PC and laptop) at the same time using the same Jabber ID.

The **Resource** name is used to distinguish between these devices. The phone cannot log in with the messenger server if it does not have a resource name.

You should assign a **Priority** as each message will only be sent to one device for each Jabber ID. The **Priority** determines which of the devices receives the message.

Example: You are online using one of your phone's handsets and your PC both at the same time. You have assigned your phone (**Resource** name "phone") **Priority** 5 and your PC (**Resource** name "PC") **Priority** 10. In this case, any message addressed to your Jabber ID will be sent to your phone.

- ▶ Open the following Web page: **Settings** → **Messaging** → **Messenger**.

- ▶ In the **Messenger Account** field, select whether you wish to use the **Gigaset.net** Jabber server or another provider's messenger server (**Other**).
The access data for **Gigaset.net** is already stored in the base station. It is displayed in **Jabber ID**, **Authentication password** and **Jabber server**. With this data you can also register with the Gigaset.net Jabber server through your PC.
- ▶ Enter the user ID (max. 50 characters) and password (max. 20 characters) that you used to register with the messenger server in the **Jabber ID** and **Authentication password** fields. If you have selected **Messenger Account = Gigaset.net**, the fields are preconfigured with your Gigaset.net account.
- ▶ In the **Jabber server** field, enter the IP address or the DNS name of the messenger server with which you are registered for instant messaging.
Max. 74 alphanumeric characters.
If you have selected **Messenger Account = Gigaset.net**, the field is preconfigured with the name of the Gigaset.net server.
- ▶ Enter the number of the communication port on the Jabber server in the **Jabber server port** field. The default port is 5222.
If you have selected **Messenger Account = Gigaset.net**, the port number is preconfigured.
- ▶ Enter a resource name (max. 20 characters) in the **Resource** field.
The default is: **phone**.
- ▶ Enter the priority for your phone in the **Priority** field. Select a number between -128 (highest priority) and 127 (lowest priority) for the priority.
The default is: 5
- ▶ Click **Set**.

Setting up Gigaset.net Jabber account

Your phone is already registered with the Gigaset.net Jabber server. An account has been assigned to your phone.

In order to chat with other Gigaset.net subscribers via this account, you must transfer the required Gigaset.net subscribers to a contact list (buddy list) on your PC. You can use any conventional Jabber client for this (e.g. PSI, Miranda; see e.g. <http://www.swissjabber.ch>).

In order to use the Gigaset.net Jabber account, proceed as follows:

- ▶ Start the Web configurator, open the **Settings** → **Messaging** → **Messenger** Web page and select the **Messenger Account Gigaset.net** field. Your account data is displayed in **Jabber ID** and **Authentication password**. You will need these to create a buddy list via the Jabber client on the PC.
- ▶ Start your Jabber client on the PC.
- ▶ Enter your Gigaset.net **Jabber ID** on the Jabber client as a new account. The **Jabber ID** consists of your Gigaset.net number and "@jabber.gigaset.net"
Example: 12345678901#9@jabber.gigaset.net
- ▶ Then enter your **Authentication password**.

Please note:

- Do **not** select the option "Create new account". Your Gigaset.net Jabber account has already been created in Gigaset.net.
- The option "SSL connection" must be **deactivated** in the Jabber client.

Making e-mail settings

- ▶ Now you can enter Gigaset.net subscribers as contacts (buddies).

For the Jabber ID of each subscriber, enter the subscriber's Gigaset.net number with "@jabber.gigaset.net" (example: 2141524901#9@jabber.gigaset.net).

A request to "Add to contact list" will be sent to the subscriber.

If the subscriber accepts this request, they will be added to your buddy list. This updated buddy list will be displayed on the handset the next time the messenger is rebooted. To restart: If necessary, close your connection to the messenger server (page 87) and then go back online (page 85).

Please note:

For how to use your handset to go online and chat with or call buddies, see page 84.

Making e-mail settings

You can use your phone to be notified about new e-mail messages on your incoming e-mail server (page 81).

You must store the address/DNS name of your incoming e-mail server and your personal access data in the phone and activate the e-mail check with the incoming e-mail server, so that the phone can connect to the incoming e-mail server and your mailbox.

- ▶ Open the following Web page: **Settings** → **Messaging** → **E-Mail**.
- ▶ Enter the user name (account name) agreed with the Internet provider (max. 50 characters) in the **Authentication Name** field.
- ▶ Enter the password agreed with the provider for accessing the incoming e-mail server (max. 32 characters; case sensitive) in the **Authentication password** field.
- ▶ Enter the name of the incoming e-mail server (POP3 server) (max. 74 characters) in the **POP3 Server** field. Example: pop.theserver.com.
- ▶ From the **Check for new e-mail** list select the time interval at which your phone should check if new e-mail messages have arrived in your incoming e-mail server. Select **Never** to deactivate the prompt. Select one of the other values to activate the prompt for new e-mail messages.
- ▶ Click **Set** to save the settings in your phone.

Please note:

For how to show the messages from your mailbox on your handset, see page 81.

Activating/deactivating info services

You can configure your registered Gigaset C47H handsets to display customised text information (e.g. weather reports, RSS feeds) in the idle display.

Precondition: The **Clock** is set as a screen picture on the handset (page 107).

Incoming text information will overwrite the screen picture.

You can activate and deactivate the display of text information for every handset.

- ▶ Open the following Web page: **Settings** → **Services**.
- ▶ In the **Info services on screensaver** area, activate **Yes / No** to activate or deactivate the display of text information.
- ▶ Click **Set** to save the settings in your phone.

Configuring info services

- ▶ Click the link
www.gigaset.net/myaccount
or enter the URL into the address field of a different browser window.
- ▶ Enter the account data shown in the **Info services on screensaver** area into the fields for the user account.

This will open a Web page where you can compile your info service.

- ▶ Define which information should be sent regularly to your handset.

Selecting and registering online directories for access

You can use online directories (net directory and yellow pages) on your handset. You can use your telephone's Web configurator to define which online directories you wish to use.

You can also elect to display the name under which the caller making an incoming call is saved in the online or Gigaset.net directory (**Display of caller's name**) – in the call display and in the caller list. **Precondition:** This function is supported by the provider of the online directory.

- ▶ Open the following Web page: **Settings** → **Services**.
The settings are carried out in the **Online Directory** area.
- ▶ Select the provider whose online directory you wish to use from the **Provider** list. Select "----" if you do not wish to use an online directory.

The following fields are displayed depending on the **Provider** you select:

Display of caller's name

This is displayed if the provider supports transmission of the caller name from the online directory to the call display.

- ▶ Click **On** to update the display.

Changing internal handset numbers and names

Authentication Name, Authentication password



These are displayed if you need to register with the provider to gain access to certain services:

- Some providers require you to register every time you want to access their online directory. They require registration with user name and password for access to the online directory. You will need to save this data to your base station.
- Other providers differentiate between standard and premium services. You can access standard services **without** first entering user name and password. But you will have to register to use the premium services. You will need to save the access data to your base station to gain access to premium services.

▶ Enter the details you received from your provider in the **Authentication Name** and **Authentication password** fields.

▶ Click the **Set** button to save the settings in your phone.

Please note:

- For how to use online directories on handsets, see page 53.
- The provider-specific name of the online directory and classified directory are displayed in the list of online directories on the handset (press and **hold** )
- The handset directories (press  **briefly**) always display the entries **Net Directory** and **Yellow Pages** for online and classified directories (regardless of the selected provider). However, connections are made to the selected online directories.
- If you select "–" from the **Provider** list the entries for online and classified directories will not be displayed in the handset's list of online directories. The directory entries **Net Directory** and **Yellow Pages** are maintained but cannot be used to make any connections.

Changing internal handset numbers and names

Each handset is **automatically** assigned an internal number (1 to 6) and an internal name ("INT 1", "INT 2" etc.) when it registers with the base station (page 98).

The internal numbers and names of all registered handsets can be changed.

Please note:

You can read how to change internal names and numbers from page 100 on.

▶ Open the following Web page: **Settings** → **Handsets**.

The names and internal numbers of all registered handsets are displayed in the **Registered Handsets** area.

- ▶ Select the handset whose number/name you want to change.
- ▶ **Changing numbers:** Select the internal number that you want to assign to the handset in the **No.** column of the handset. If a handset with this internal number already exists, you will also have to change the number allocation for this handset. The internal numbers 1-6 can only be assigned once each.
- ▶ **Changing names:** If necessary, change the name of the handset in the **Name** column. The name may contain up to 10 characters.
- ▶ If necessary, repeat the process for other handsets.
- ▶ Click **Set** to save the settings.

The changes are present in the internal lists of all registered handsets. Handsets are sorted by their internal numbers in the internal list. The order of the handsets in the list can therefore be changed.

Please note:

If an internal number has been entered twice, a message will appear. The internal numbers are not changed.

Loading and deleting handset directories to/from the PC

The Web configurator has the following options for editing the directories of the registered handsets.

- ◆ Store the handset directories on a PC. Entries are stored in vCard format in a vcf file on the PC. You can edit these files with an ASCII editor (e.g. Notepad/Editor in Windows Accessories) and load them onto any handset. You can also transfer directory entries to your PC address book (e.g. Outlook Express™ address book).
- ◆ Transfer contact details from your PC address book to handset directories. Export the contacts, e.g. with Outlook Express™ to vcf files (vCards) and transfer them to handset directories using the Web configurator.
- ◆ Delete the directory on the handset. If you have edited the directory file (vcf file) on the PC and would like to use this modified directory on the handset, you can delete the current directory from the handset first.
- ◆ **Tip:** Back up the current directory on your PC before deleting it. You can then load it back onto the handset if the modified directory is affected by formatting errors and some, or all, of it cannot be loaded onto the handset.

Please note:

- You can find information on the vCard format (vcf) on the Internet, e.g. under: www.en.wikipedia.org/wiki/VCard or www.de.wikipedia.org/wiki/VCard (You can set the display language at the bottom left-hand side in the navigation area of the Web page.)
- You can still load directories in tsv format from your PC to your handset.
- If you want to transfer a handset directory (vcf file) saved on the PC that contains numerous entries to a Microsoft Outlook™ address book, please note the following: Microsoft Outlook™ only ever transfers the first (directory) entry from the vcf file to its address book.

Preconditions:

- ◆ The handset can send and receive directory entries.
- ◆ The handset is activated and is in idle status.
- ▶ Open the following Web page: **Settings** → **Handsets**.

The names of all registered handsets are displayed in the **Directory** area.

- ▶ Select the handset for which you want to save or edit the directory. To do this, click on the option before the handset.

Loading the directory file from the PC to the handset

- ▶ In the **Transfer directory to handset** area, enter the vcf file you want to load on to the handset (complete path name), or click **Browse...** and navigate your way to the file.
- ▶ Click the **Transfer** button to start the transfer.

The display will show how many of the entries from the vcf file are being transferred to the directory.

Transfer rules

The directory entries from a vcf file that are loaded onto the handset will be added to the directory. If an entry already exists for a name, it will either be supplemented or a new entry for the name will be created. The process will not overwrite or delete any phone numbers.

Please note:

Depending on your handset, up to 3 entries with the same name will be created in the handset directory for each vCard – one entry per entered number.

Loading the directory from the handset to the PC

- ▶ In the **Handset Directory** area, click **Save**. A Windows dialogue will be shown to save the file.
- ▶ Enter the directory on the PC (complete path name) in which the directory file is to be stored. Click **Save** or **OK**.

Deleting the directory

- ▶ In the **Handset Directory** area, click **Delete**.
- ▶ Confirm the security prompt **Telephone directory of the selected handset will be deleted. Continue?** with **OK**.

This deletes all the entries in the directory, including the entries for online directories.

Please note:

For how to delete the directory on the handset, see page 52.

Directory content (vcf file)

The following data (if available) is written into the vcf file for entry into the directory or transferred from a vcf file into the handset directory.

1. Name
2. First name
3. Number
4. Number (office)
5. Number (mobile)
6. E-mail address
7. Date (YYYY-MM-DD) and time of the reminder call (HH:MM) separated by a "T"
(example: 2008-01-12T11:00)
8. Identification as VIP (X-SIEMENS-VIP:1)

Other information that a vCard may contain is not entered into the handset directory.

Example for an entry in vCard format:

```
BEGIN:VCARD
VERSION:2.1
N:Smith;Anna
TEL;HOME:1234567890
TEL;WORK:0299123456
TEL;CELL:0175987654321
EMAIL:anna@smith.com
BDAY:2008-01-12T11:00
X-SIEMENS-VIP:1
END:VCARD
```

Activating VoIP status message display

You can display VoIP status messages on your handset when there are VoIP connection problems. These messages give you information on the status of a connection and contain a provider-specific status code that helps the service team when they are analysing the problem.

- ▶ Open the following Web page: **Settings** → **Handsets**.
The settings are carried out in the **Miscellaneous** area.
- ▶ Click the **Yes** option next to **Show VoIP status on handset** to activate the status message display.
If you click **No**, no VoIP status messages are displayed.
- ▶ Click **Set** to save the changes.

Please note:

A table with possible status codes and their meaning can be found in the appendix on page 168.

Starting a firmware update

If necessary, you can load updates of the base station firmware onto your phone.

The server on which Siemens makes new firmware versions available for your base station is set by default. The URL of the Internet server is displayed in the **Data server** field.

You should only change this URL under exceptional circumstances (e.g. if requested to do so due to erroneous behaviour). This address is also used to load provider information from the Internet. You should therefore make a note of the default URL before you overwrite it. Otherwise, you will only be able to reactivate the default URL by resetting the base station back to the factory settings (page 114).

Please note:

- When updating from the Internet, checks are made to ensure that no **newer** version of the firmware exists. If this is not the case, the operation is terminated.
- The firmware is only loaded from the Internet if you have not entered a local file in the **User defined firmware file** field prior to the update.

Starting a firmware update

Preconditions:

- ◆ No calls are being made via the fixed line network or VoIP.
- ◆ There is no connection between registered handsets.
- ◆ The base station menu is not open in any of the handsets.
- ▶ Open the following Web page: **Settings** → **Miscellaneous**.
- ▶ Click **Update Firmware**.

The firmware is updated. This process can take up to 3 minutes.

Please note:

You can also start the firmware update on the handset (page 116).

Firmware update from local firmware file

It is possible under exceptional circumstances that you receive, for instance, a firmware file from Service that you can upload from your PC to your telephone (e.g. because the firmware update via the Internet did not work).

Precondition: A Web server is running on the local PC (e.g. Apache).

- ▶ First load the firmware file onto your PC.
- ▶ In the **User defined firmware file** field enter the IP address of the PC in your local network and then complete path and name of the firmware file on the PC. Example:
192.168.2.105/C470IP/FW_file.bin.
- ▶ Click **Set** to save the changes.
- ▶ Click the **Update Firmware** button to start the update.

This setting is automatically used for **this particular** firmware update. The URL in the **Data server** field is saved and used again for subsequent firmware updates. You will have to re-enter IP address and file name if you need to carry out another firmware update on your local PC.

Please note:

If an error arises during a firmware update from a local PC, the most recent version of the firmware is automatically downloaded from the Internet.

Activating/deactivating the automatic version check

When the version check is activated, the phone checks on a daily basis whether the Siemens configuration server is carrying a new version of the phone firmware or of the file with the general settings for your VoIP provider.

If a new version is available, a notification is sent to the handset and the message key flashes. You can then carry out an automatic update of the firmware (page 117) or of the VoIP provider settings (page 119).

- ▶ Open the following Web page: **Settings** → **Miscellaneous**.
- ▶ Click **Yes** next to **Automatic check for software/profile updates** to activate the automatic version check.
Click **No** if you do not want a version check to be carried out.
- ▶ Click **Set** to save the changes.

Copy date and time from time server

The date and time are shown in the idle display of registered handsets. They are important, for example, for stating the correct time in the calls list and for the "alarm clock" function.

There are two methods for updating the time and date on your base station: manually with one of the registered handsets (page 13) or automatically by synchronisation with a time server on the Internet.

Activate/deactivate synchronisation with a time server as follows:

- ▶ Open the following Web page: **Settings** → **Miscellaneous**.
- ▶ In the **Automatic adjustment of System Time with Time Server** field select **Yes** to activate synchronisation between base station and a time server. If you select **No** the base station will not adopt time settings from a time server. In this case you should set the time and date manually using a handset.
- ▶ The **Last synchronisation with time server** field shows the last time when the base station compared time and date settings with a time server.
- ▶ In the **Time Server** field, enter the Internet address or name of the time server from which the base station should adopt its time and date settings. The time server "europe.pool.ntp.org" is set as default on the base station. You can overwrite the setting.
- ▶ From the **Country** list, select the country in which your base station is being operated.
- ▶ The **Time Zone** field shows the valid time zone for the **Country**. It shows the deviation between local time (not summer time) and Greenwich Mean Time (GMT).
If a country is divided into various time zones, they will all appear in the list. Select the appropriate **Time Zone** for the base station from the list.
- ▶ The **Automatically adjust clock to summer-time changes** field will be displayed if your time zone differentiates between summer time and winter time.
Activate **On** if you want the time to change automatically to summer time or winter time when summer time begins and ends respectively.
Activate **Off** if you do not want to change to summer time.

Querying the phone status

Please note: If the date and time are updated by a time server that automatically switches between summer time and standard time, you must always activate **Off** here.

- ▶ Click **Set** to save the settings in your phone.

Once you have activated synchronisation, the time and date will be compared with a time server as soon as an Internet connection is established.

Synchronisation will usually occur once a day (at night) if synchronisation is activated. Any additional synchronisation will take place only after each new system start of the base station (e.g. after a firmware update or a power cut).

If you register a new handset on your base station it will assume the time and date of the base station without any additional synchronisation with the time server.

Date and time settings are transferred to every handset after synchronisation.

Please note:

- The default time server "europe.pool.ntp.org" will remain stored in the base station even if you overwrite it. If you delete your time server from the **Time Server** field and synchronisation is still activated, the base station will return to synchronisation with the default time server. However, it will no longer appear in the **Time Server** field.
- The base station will return to synchronisation with the default time server if you have entered your own time server in the **Time Server** field and the base station is unable to synchronise time and date for ten consecutive attempts.
- If you have deactivated synchronisation with a time server, and if the date and time are not set on any handset, then the base station will attempt to reference date and time settings from the CLIP information of an incoming call.

Querying the phone status

General information about your phone is displayed.

- ▶ In the menu list, click the **Status** tab.

The following information is displayed:

IP Configuration

IP address

The phone's current IP address within the local network. For assigning the IP address, see page 130.

MAC address

The phone's device address.

Software

Firmware version

Version of the firmware currently downloaded. You can download updates of the firmware on your phone (page 116). Firmware updates are available on the Internet.

EEPROM version

Version of your phone's EEPROM storage chip (page 192).

Appendix

Care

- ▶ Wipe down the base station and handset with a **damp** cloth (no solvents) or an anti-static cloth.

Never use a dry cloth. This can cause a build up of static.

Contact with liquid

If the handset should come into contact with liquid:

- ▶ **Switch the handset off and remove the batteries immediately.**
- ▶ Allow the liquid to drain from the handset.
- ▶ Pat all parts dry, then with the battery compartment open and the keypad facing down place the handset in a dry, warm place **for at least 72 hours (not in a microwave, oven etc.)**.
- ▶ **Do not switch on the handset again until it is completely dry.**

When it has fully dried out, you will normally be able to use it again.

Questions and answers

If you have any questions about using your phone, visit us at www.siemens.com/gigasetcustomercare at any time. The table below contains a list of common problems and possible solutions.

Please note:

To support the service team, it can be helpful if you have the following information to hand:

- Version of firmware, EEPROM and your phone's MAC address
You can check this information with the Web configurator (page 162). For how to display the MAC address on your handset, turn to page 121.
- VoIP status code (page 168)

For problems with VoIP connections, you should set VoIP status messages to be displayed on your handset. (page 119, page 159). These messages contain a status code that helps when the problem is analysed.

The display is blank.

1. The handset is not switched on.
 - ▶ Press **and hold** the end call key .
2. The battery is flat.
 - ▶ Charge the battery or replace it (page 11).

The keys of a handset do not respond when pressed.

The keypad lock is activated.

- ▶ Press and **hold** the hash key  (page 37).

Base "X" flashes on the display.

1. The handset is out of range of the base station or the base station's range has changed because eco mode is active.
 - ▶ Move the handset closer to the base station.
 - ▶ If necessary, deactivate eco mode (page 24).
2. The handset has been de-registered.
 - ▶ Register the handset (page 98).
3. The base station is not turned on.
 - ▶ Check the base station's mains adapter (page 15).
4. An update of the base station firmware is currently being conducted (page 116/page 159).
 - ▶ Please wait until the update is complete.

Base Search flashes in the display.

The base station is out of range or switched off.

- ▶ Move the handset closer to the base station.
- ▶ Check the base station mains adapter.

Handset does not ring.

1. The ringer tone is switched off.
 - ▶ Activate the ringer tone (page 111).
2. Call forwarding set to **All Calls**.
 - ▶ Deactivate call forwarding (fixed line network page 45; VoIP page 47/page 146).

You cannot hear a ringer/dialling tone from the fixed line network.

The phone cord supplied has not been used or has been replaced by a new cord with the wrong jack pin connections.

- ▶ When purchasing a new cord, ensure that it has the correct pin connections (page 17).

Error tone sounds after system PIN prompt.

You have entered the wrong system PIN.

- ▶ Enter system PIN if required.

Have you forgotten the system PIN?

- ▶ Carry out a reset on the base station to set the system PIN back to 0000 (page 115).

The other party cannot hear you.

You have pressed the  (INT) key. The handset is "muted".

- ▶ Activate the microphone again (page 36).

When making calls from the fixed line network, the caller's phone number is not displayed although CLIP (page 33) is set.

Calling Line Identification is not enabled.

- ▶ The **caller** should ask his network provider to enable Calling Line Identification (CLI).

You hear an error tone when keying an input (a descending tone sequence).

Action has failed/invalid input.

- ▶ Repeat the operation.
 Watch the display and refer to the user guide if necessary.

You cannot connect to the router and the phone is assigned a static IP address.

- ▶ Check on the router whether the IP address is already being used by another device in the LAN or belongs to the block of IP addresses that is reserved on the router for dynamic address assignment.
- ▶ If necessary, change the phone's IP address (page 120).

You have made a call via VoIP but cannot hear the other caller.

Your phone is connected to a router with NAT/firewall.

- ▶ Your STUN server (page 138) or outbound proxy (page 138) settings are incomplete or incorrect. Check the settings.
- ▶ No outbound proxy is entered or the outbound proxy mode **Never** is activated (page 138) and your phone is connected to a router with symmetric NAT or a blocking firewall.
- ▶ Port forwarding is activated on your router, but no permanent IP address has been assigned to your phone.

You cannot make calls via VoIP. Server not accessible! is displayed.

- ▶ First wait a few minutes. This is often a short-term event that corrects itself after a short time. If the message is still displayed, proceed as follows:
- ▶ Check whether your phone's Ethernet cable is correctly connected to the router.
- ▶ Check your router's cable connection to the Internet.
- ▶ Check whether the phone is connected to the LAN. Send a ping command, e.g. from your PC, to the phone (ping □ <local IP address of the phone>). It may be that no IP address could be assigned to the phone or a permanently set IP address is already assigned to another LAN subscriber. Check the settings on the router, you may have to activate the DHCP server.

You cannot make calls via VoIP. Either Provider registration failed! or Registration failed is shown.

- ▶ First wait a few minutes. This is often a short-term event that corrects itself after a short time. The message may still be displayed for the following reasons:
1. The personal VoIP access data (**Username**, **Authent. Name** and **Authent. Password**) you have entered may be incomplete or wrong.
 - ▶ Check your information. In particular, check your use of upper and lower case.
 2. The general settings for your VoIP provider are incomplete or incorrect (incorrect server address).
 - ▶ Start the Web configurator and check the settings.

You cannot make calls via VoIP. The display shows IP configuration error: xxx or VoIP config.error: xxx (xxx = VoIP status code).

You are trying to make a call via a VoIP connection that is not properly configured.

- ▶ Start the Web configurator and check the settings. Possible status codes and their meanings are listed on page 168.

The phone does not dial an entered number. The display shows Not possible!

The number may be blocked (dial rule).

- ▶ Open the **Dialling Plans** Web page of the Web configurator and delete or deactivate the block.

You cannot establish a connection to the phone with your PC's Web browser.

- ▶ When establishing a connection, check the phone's local IP address that has been entered. You can check the IP address on your handset.
- ▶ Check the LAN connections for the PC and phone.
- ▶ Check that your phone can be reached. Send a ping command, e.g. from your PC, to the phone (ping □ <local IP address of the phone>).
- ▶ You have tried to reach the phone via a secure http (https://...). Try again with http://....

You cannot be reached for calls from the Internet.

- ▶ There is no entry for your phone in your router's routing table. Check the settings for the **NAT refresh time** (page 138).
- ▶ Your phone is not registered with the VoIP provider.
- ▶ You have entered the wrong user ID or an incorrect domain (page 136).

No firmware update or VoIP profile download is carried out.

1. If **Currently not possible!** is displayed, the VoIP connections may be busy or a download/update is already being carried out.
 - ▶ Repeat the process at a later time.
2. If **File corrupted!** is displayed, the firmware or profile file may be invalid.
 - ▶ Please only use firmware and downloads that are made available on the preconfigured Siemens server (page 159) or at www.siemens.com/gigasetcustomer-care.
3. If **Server not accessible!** is displayed, the download server may not be accessible.
 - ▶ The server is currently not accessible. Repeat the process at a later time.
 - ▶ You have changed the preconfigured server address (page 159). Correct the address. If necessary, reset the base station.
4. If **Transmission Error XXX** is displayed, an error has occurred in the transmission of the file. An HTTP error code is displayed for XXX.
 - ▶ Repeat the process. If the error occurs again, consult the Service department.
5. If **Check IP settings!** is displayed, your phone may not be connected to the Internet.
 - ▶ Check the cable connections between the phone and router and between the router and the Internet.
 - ▶ Check whether the phone is connected to the LAN, i.e. it can be reached at its IP address.

You cannot listen to or control the network mailbox.

VoIP:

Your VoIP provider does not support the type of DTMF signalling set up on your phone.

- ▶ Ask your VoIP provider which signalling it supports and change the settings on your phone (page 146) if necessary.

Operating the base station within a PABX:

Your PABX is set for dial pulsing.

- ▶ Set your PABX to touch tone dialling.

No time is specified for a message in the call history.

Date/time is not set.

- ▶ Set date/time (page 13) or
- ▶ Activate base station synchronisation with a time server on the Internet (page 161).

The integrated answer machine of your Gigaset C475 IP reports "Invalid PIN" on remote operation.

1. You have entered the wrong system PIN.
 - ▶ Enter the system PIN again.
2. The system PIN is still set to 0000.
 - ▶ Change the system PIN (page 114).

The answer machine of your Gigaset C475 IP does not record messages/has switched to notification announcement.

Its memory is full.

- ▶ Delete old messages.
- ▶ Play back new messages and delete.

The answer machine of your Gigaset C475 IP will not record a conversation or interrupts the recording.

The display shows **Delete messages**.

The answer machine's memory is full.

- ▶ Use a different handset to delete messages from the answer machine and restart two-way recording.

Or:

- ▶ Finish the call, delete old messages from the answer machine and re-establish the connection.

VoIP status codes

If you have problems with your VoIP connections, activate the **Show Stat. on HS** function (page 119, page 159). You will then receive a VoIP status code that will support you in problem analysis. Also enter the code during problem analysis by the Service department. In the following tables you will find the meanings of the most important status codes and messages.

Status code	Meaning
0x31	IP configuration error: IP domain not entered.
0x33	IP configuration error: SIP user name (Authentication Name) not entered. This is shown, for example, when dialling with a line suffix, if no connection is configured for the suffix on the base station.
0x34	IP configuration error: SIP password (Authentication password) not entered.
0x300	The called party can be reached under several phone numbers. If the VoIP provider supports this, a list of the phone numbers is transmitted as well as the status code. The caller can select to which number he wants to make the connection.
0x301	Permanently redirected. The called party can no longer be reached under this number. The new number is transferred to the phone together with the status code, and the phone then no longer accesses the old number but dials the new address immediately.
0x302	Temporarily redirected. The phone is informed that the called party cannot be reached under the number dialled. The duration of redirecting is time-limited. The phone is also notified of the duration of redirecting.
0x305	The query is sent to a different "proxy server", e.g. to balance out incoming queries. The phone will make the same query once again to another proxy server. This is not a redirection of the address per se.
0x380	Other service: The query or the call could not be made. But the phone is notified what other options there are to be able to connect the call.
0x400	Wrong call
0x401	Not authorised
0x403	The requested service is not supported by the VoIP provider.
0x404	Wrong phone number. No caller on this number. Example: In a local call you have not dialled the area code although your VoIP provider does not support local calls.
0x405	Method not permitted.
0x406	Not acceptable. The requested service cannot be provided.
0x407	Proxy authentication required.
0x408	The party cannot be reached (e.g. account has been deleted).
0x410	The requested service is not available from the VoIP provider.

Status code	Meaning
0x413	Message is too long.
0x414	URI is too long.
0x415	Query format is not supported.
0x416	URI is faulty.
0x420	Incorrect ending
0x421	Incorrect ending
0x423	The requested service is not supported by the VoIP provider.
0x480	The dialled number is temporarily unavailable.
0x481	The recipient is not available.
0x482	Double service query
0x483	Too many "hops": The query was rejected because the service server (proxy) has decided that this query has already passed through too many service servers. The maximum number was previously specified by the original sender of the query.
0x484	Wrong number: In most cases this response means that you have simply omitted one or more digits in the phone number.
0x485	The URI dialled is not unique and cannot be processed by the VoIP provider.
0x486	The called party is busy.
0x487	General faults: The call was interrupted before a call was established. The status code confirms receipt of the interruption signal.
0x488	The server cannot process the query because the data entered in the media description is not compatible.
0x491	The server notifies that the query will be processed as soon as a previous query has been completed.
0x493	The server rejects the query because the phone cannot decrypt the message. The sender has used an encryption method that neither the server nor the receiver phone can decrypt.
0x500	The proxy or the receiving device has discovered a fault while executing the query, which makes further execution of the query impossible. In this case, the caller or the phone displays the fault and repeats the query after a few seconds. The number of seconds after which the query can be repeated may be transmitted to the caller or phone by the receiving device.
0x501	The query cannot be processed by the recipient because the recipient does not have the functionality that the caller requires. If the recipient understands the query but does not process it because the sender does not have the necessary rights or the query is not permitted in the current context, a 405 is sent instead of 501.
0x502	In this case, the receiving device that transmits this error code is a proxy or a gateway and has received an invalid response from its gateway via which this query is to be processed.

Questions and answers

Status code	Meaning
0x503	The query cannot currently be processed by the receiving device or the proxy because the server is either overloaded or is being serviced. If it is possible for the query to be repeated in the foreseeable future, the server informs the caller or the phone of this.
0x504	Time limit at the gateway
0x505	The server rejects the query because the indicated version number of the SIP protocol does not at least concur with the version that is used by server or the SIP device involved in this query.
0x515	The server rejects the query because the message exceeds the maximum permitted size.
0x600	The called party is busy.
0x603	The called party has rejected the call.
0x604	The called URI does not exist.
0x606	The communication settings are not acceptable.
0x701	The called party has hung up.
0x703	Connection interrupted because of time-out.
0x704	Connection interrupted because of a SIP error.
0x705	Wrong dialling tone
0x706	No connection established
0x751	Busy tone: No codec match between the calling and called party.
0x810	General socket layer error: User is not authorised.
0x811	General socket layer error: Wrong socket number
0x812	General socket layer error: Socket is not connected.
0x813	General socket layer error: Memory error.
0x814	General socket layer error: Socket not available – check IP settings / connection problem / VoIP setting incorrect.
0x815	General socket layer error: Illegal application on the socket interface.

Checking service information

You may need the service information of your phone (base station and handset) for Customer Services.

Base station service information

Precondition: You are conducting an external call. The connection has been established for at least 8 sec.

Options → **Service Info**

Confirm selection with **OK**.

The following information is displayed:

- 1: Serial number of the base station (RFPI)
- 2: Serial number of your handset (IPUI)
- 3: Informs the service employees of the base station settings (in hex diagram), e.g. the number of registered handsets, repeater mode. The last 4 digits indicate the number of operating hours (hexadecimal).
- 4: Variant, version of the firmware (digits 3 to 5).
- 5: Gigaset.net number of your phone. With this number you can call a service employee over the Internet without needing to be registered with a VoIP provider. This means that the employee can test online connections and VoIP telephony irrespective of the VoIP provider.

Service information of the handset

In the handset idle status:

Open the menu by pressing .

► Press the following keys one after the other:     

The following information, among other details, is displayed on the handset:

- 1: Serial number (IPUI)
- 2: Number of operating hours
- 3: Variant, version of handset software

Service (Customer Care)

We offer you support that is fast and tailored to your specific needs!

Our Online Support on the Internet can be reached any time from anywhere.

<http://www.siemens.com/gigasetcustomercare>

It provides you with 24/7 support for all our products. It also provides a list of FAQs and answers plus user guides and current software updates (if available for the product) for you to download.

You will also find frequently asked questions and answers in the appendix of this user guide.

For personal advice on our range of products and assistance with repairs or guarantee/warranty claims you can contact us on:

UK helpdesk: 0 84 53 67 08 12.

Please have your proof of purchase ready when calling with regard to guarantee/warranty claims.

Replacement or repair services are not offered in countries where our product is not sold by authorised dealers.

Please address any questions about DSL access and VoIP access to the respective service provider.

Authorisation

This device is intended for analogue phone lines in the UK.

Voice over IP telephony is possible via the LAN interface if an additional modem has been connected.

Country-specific requirements have been taken into consideration.

We, Siemens Home and Office Communication Devices GmbH & Co. KG, declare that this device meets the essential requirements and other relevant regulations laid down in Directive 1999/5/EC.

A copy of the 1999/5/EC Declaration of Conformity is available at this Internet address:

<http://www.siemens.com/gigasetdocs>.

CE 0682

Guarantee Certificate United Kingdom

Without prejudice to any claim the user (customer) may have in relation to the dealer or retailer, the customer shall be granted a manufacturer's Guarantee under the conditions set out below:

- ◆ In the case of new devices and their components exhibiting defects resulting from manufacturing and/or material faults within 24 months of purchase, Siemens shall, at its own option and free of charge, either replace the device with another device reflecting the current state of the art, or repair the said device. In respect of parts subject to wear and tear (including but not limited to, batteries, keypads, casing), this warranty shall be valid for six months from the date of purchase.
- ◆ This Guarantee shall be invalid if the device defect is attributable to improper treatment and/or failure to comply with information contained in the user guides.
- ◆ This Guarantee shall not apply to or extend to services performed by the authorised dealer or the customer themselves (e. g. installation, configuration, software downloads). User guides and any software supplied on a separate data medium shall be excluded from the Guarantee.
- ◆ The purchase receipt, together with the date of purchase, shall be required as evidence for invoking the Guarantee. Claims under the Guarantee must be submitted within two months of the Guarantee default becoming evident.
- ◆ Ownership of devices or components replaced by and returned to Siemens shall vest in Siemens.
- ◆ This Guarantee shall apply to new devices purchased in the European Union. For Products sold in the United Kingdom the Guarantee is issued by: Siemens Home and Office Communication Devices GmbH & Co. KG, Schlavenhorst 66, D-46395 Bocholt, Germany.
- ◆ Any other claims resulting out of or in connection with the device shall be excluded from this Guarantee. Nothing in this Guarantee shall attempt to limit or exclude a Customers Statutory Rights, nor the manufacturer's liability for death or personal injury resulting from its negligence.
- ◆ The duration of the Guarantee shall not be extended by services rendered under the terms of the Guarantee.
- ◆ Insofar as no Guarantee default exists, Siemens reserves the right to charge the customer for replacement or repair.
- ◆ The above provisions does not imply a change in the burden of proof to the detriment of the customer.

To invoke this Guarantee, please contact the Siemens telephone service. The relevant number is to be found in the accompanying user guide.

Specifications

Recommended batteries

Technology: Nickel-metal-hydride (NiMH)
Size: AAA (Micro, HR03)
Voltage: 1.2 V
Capacity: 600–1200 mAh

We recommend the following battery types, because these are the only ones that guarantee the specified operating times, full functionality and long service life:

- ◆ Sanyo Twicell 650
- ◆ Sanyo Twicell 700
- ◆ Panasonic 700 mAh "for DECT"
- ◆ GP 700mAh
- ◆ Yuasa AAA Phone 700
- ◆ Varta Phone Power AAA 700mAh
- ◆ GP 850 mAh
- ◆ Sanyo NiMH 800
- ◆ Yuasa AAA 800

The device is supplied with two recommended batteries.

Handset operating times/charging times

The operating time of your Gigaset depends on the capacity and age of the batteries and the way they are used. (All times are maximum possible times and apply when the display backlight is switched off).

	Capacity (mAh)			
	500	700	900	1100
Standby time (hours)	180	250	320	395
Talktime (hours)	9	12	16	19
Operating time for 1.5 hrs of calls per day (hours)	80	115	150	180
Charging time, charging cradle (hours)	5	7	9	11

At the time of going to print, batteries up to 900 mAh were available and had been tested in the system. Due to the constant progression in battery development, the list of recommended batteries in the FAQ section of the Gigaset Customer Care pages is regularly updated:

www.siemens.com/gigasetcustomercare

Power consumption for base station and charger

The power consumption for the base station is approx. 1.3 watt.

The power consumption for the charging cradle is approx. 0.5 watt.

General specifications

Interfaces	Fixed line network, Ethernet
No. of channels	60 duplex channels
Radio frequency range	1880–1900 MHz
Duplex method	Time multiplex, 10 ms frame length
Channel grid	1728 kHz
Bit rate	1152 kbit/s
Modulation	GFSK
Language code	32 kbit/s
Transmission power	10 mW, average power per channel
Range	up to 300 m outdoors, up to 50 m indoors
Base station power supply	230 V ~/50 Hz
Environmental conditions in operation	+5 °C to +45 °C; 20% to 75% relative humidity
Codecs	G.711, G.726, G.729AB with VAD/CNG, G.722
Quality of Service	TOS, DiffServ
Protocols	DECT, GAP, SIP, RTP, DHCP, NAT Traversal (STUN), HTTP

Icons

This section explains the meaning of certain icons and typographical conventions that are used in this user guide.

Copy Entry / Copy List (example)

Select one of the two specified menu functions.



Enter digits or letters.



The display keys' current functions are shown reverse highlighted in the bottom display line. Press the display key below to launch the function.



Press the control key at the top or bottom: scroll up or down.



Press the control key on the right or left: e.g. select setting.

/ / etc.

Press the matching key on the handset.

Example of a menu input

The steps you need to perform are shown in abbreviated form in the user guide. This is illustrated below using the example of "Setting the contrast for the display". The things you have to do are explained in the boxes.

 →  **Settings** → **Display**

- ▶ With the handset in idle status, press on the right of the control key to open the main menu.
- ▶ Use the control key to select the  **Settings** line – by pressing up or down on the control key repeatedly until the menu function is selected.
- ▶ Press the display key **OK** to confirm the selection.

The **Settings** submenu is displayed.

- ▶ Press up or down on the control key repeatedly until the **Display** menu function is selected.
- ▶ Press the display key **OK** to confirm the selection.

Contrast Select and press **OK**.

- ▶ Press down on the control key repeatedly until the **Contrast** menu function is selected.
- ▶ Press the display key **OK** or on the right of the control key to confirm your selection.

 Select contrast.

- ▶ Press on the right or left of the control key to set the contrast.

Save Press the display key.

- ▶ Press the display key **Save** to save the setting.

 Press and **hold** (idle status).

- ▶ Press and hold the end call key until the handset returns to idle status.

Example of multiple line input

In many situations you can change settings or enter data in several lines of a display.

In this user guide, icons are used to guide you step by step through multiple line input. This is illustrated below using the example of "Setting the date and time". The things you have to do are explained in the boxes.

To change the time, open the input field with:

 →  **Settings** → **Date/Time**

You will see the following in the display (example):



Date:

Enter day, month and year in 6-digit format.

The second line is marked with [] to show it is active.

- ▶ Enter the date using the digit keys.

Time:

Enter hours/minutes in 4-digit format.

- ▶ Press the  key.

The fourth line is marked with [] to show it is active.

- ▶ Enter the date using the digit keys.

- ▶ Save the changes.

- ▶ Press the display key **Save**.

- ▶ Then press and **hold** the  key. The handset switches to idle status.

Or:





- ▶ Press the display key **Options**.

- ▶ Select **Save** and then press the display key **OK**.

- ▶ Then press and **hold** the  key. The handset switches to idle status.

Writing and editing text

The following rules apply when writing text:





- ◆ Control the cursor with    .
- ◆ Characters are inserted to the left of the cursor.
- ◆ Press the star key  to display the table of special characters (see below "Entering special characters".)
- ◆ The first letter of the name of directory entries is automatically capitalised, followed by lower case letters.

Entering special characters

- ▶ Press the star key .

A table is opened containing all the special characters. The cursor is positioned on the character " ." (full stop).



␣	_	!	?	@	,	'	"	¤	
()	;	:	█	-	+	&	%	
*	=	<	>	/	€	£	\$	¥	
[]	\$	↵	\	~	^	¿	¡	
{	}	#							

- ▶ Navigate to the required character with the control key , . Example: to select * press 4 x  and 1 x .
- ▶ Press the display key **Insert**. The character is inserted into the text.
Pressing  again closes the table without inserting a character.

Writing text/a name

Press the relevant key several times to enter letters/characters.

Standard characters

	1x	2x	3x	4x	5x	6x	7x	8x	9x	10x
	␣ ¹⁾	↵ ²⁾	1							
	a	b	c	2	ä	á	à	â	ã	ç
	d	e	f	3	ë	é	è	ê		
	g	h	i	4	ï	í	ì	î		
	j	k	l	5						
	m	n	o	6	ö	ñ	ó	ò	ô	õ
	p	q	r	s	7	ß				
	t	u	v	8	ü	ú	ù	û		
	w	x	y	z	9	ÿ	ý	æ	ø	å
	.	,	?	!	0					

- 1) Space
- 2) Line break

When you press and **hold** a key, the characters of the corresponding key are displayed in the **bottom display line** and marked one after another. When you release the key, the highlighted character is inserted into the input field.

Setting upper/lower case or digits

Press and **hold** the hash key  before entering the character to switch from "abc" mode to "123", from "123" to "abc" and from "abc" to "Abc" (upper case: 1st letter upper case, all others lower case).

You can see briefly in the display whether upper case, lower case or digits is selected.

Gigaset C470 IP/C475 IP – Free software

The firmware for your Gigaset C470 IP/C475 IP includes free software that is licensed under the GNU Lesser General Public License. This free software was developed by a third party and is protected by copyright. You will find the licence text in its original English version on the pages that follow.

The software is provided free of charge. You are authorised to use this free software in accordance with the above-mentioned licence conditions. In the event of contradictions between these licence conditions and the licence conditions that apply for the software according to Siemens Home and Office Communication Devices GmbH & Co. KG, the above-mentioned licence conditions shall take precedence for the free software.

The GNU Lesser General Public License (LGPL) is supplied with this product. You can also download the licence conditions from the Internet:

◆ The **LGPL** is available on the Internet at:

<http://www.gnu.org/copyleft/lesser.html>

◆ The **source text, including copyright notices for free software**, is currently available on the Internet at:

<http://www.siemens.com/gigaset/developer>

For more information and Internet links to the source text of the free software, see the Online Support pages on the Internet at:

www.siemens.com/gigaset/customer-care

If it is not already supplied with the product, you can request the source text, including copyright notices, from Siemens. There is a charge to cover the cost of copying and postage. Please submit this request by e-mail or fax to the following address or fax number within 3 years of purchasing this product. Please state the exact device type plus the version number of the installed device software.

Small Parts Dispatch Com Bocholt

E-mail: kleinteileversand.com@siemens.com

Fax: 0049 2871 / 91 30 29

Use of the free software contained in this product extending beyond the program sequence intended by Siemens is at the user's own risk – i.e. there shall be no claims for liability for defects against Siemens Home and Office Communication Devices GmbH & Co. KG. The GNU Lesser General Public License contains notes regarding the author's liability for defects or that of other proprietors of the free software.

You shall have no right to assert a claim against Siemens Home and Office Communication Devices GmbH & Co. KG based on liability for defects, if a defect in the product is or could be due to changes you have made to the programs or their configuration. Furthermore, you shall have no right to assert a claim against Siemens Home and Office Communication Devices GmbH & Co. KG based on liability for defects if the free software infringes the copyright of third parties.

Siemens shall not provide technical support for the software, including the free software included within it, if it has been changed.

GNU LESSER GENERAL PUBLIC LICENSE

Version 2.1, February 1999

Copyright (C) 1991, 1999 Free Software Foundation, Inc., 59 Temple Place, Suite 330, Boston, MA 02111-1307 USA

Everyone is permitted to copy and distribute verbatim copies of this license document, but changing it is not allowed.

[This is the first released version of the Lesser GPL. It also counts as the successor of the GNU Library Public License, version 2, hence the version number 2.1.]

Preamble

The licenses for most software are designed to take away your freedom to share and change it. By contrast, the GNU General Public Licenses are intended to guarantee your freedom to share and change free software--to make sure the software is free for all its users.

This license, the Lesser General Public License, applies to some specially designated software packages--typically libraries--of the Free Software Foundation and other authors who decide to use it. You can use it too, but we suggest you first think carefully about whether this license or the ordinary General Public License is the better strategy to use in any particular case, based on the explanations below.

When we speak of free software, we are referring to freedom of use, not price. Our General Public Licenses are designed to make sure that you have the freedom to distribute copies of free software (and charge for this service if you wish); that you receive source code or can get it if you want it; that you can change the software and use pieces of it in new free programs; and that you are informed that you can do these things.

To protect your rights, we need to make restrictions that forbid distributors to deny you these rights or to ask you to surrender these rights. These restrictions translate to certain responsibilities for you if you distribute copies of the library or if you modify it.

For example, if you distribute copies of the library, whether gratis or for a fee, you must give the recipients all the rights that we gave you. You must make sure that they, too, receive or can get the source code. If you link other code with the library, you must provide complete object files to the recipients, so that they can relink them with the library after making changes to the library and recompiling it. And you must show them these terms so they know their rights.

We protect your rights with a two-step method: (1) we copyright the library, and (2) we offer you this license, which gives you legal permission to copy, distribute and/or modify the library.

To protect each distributor, we want to make it very clear that there is no warranty for the free library. Also, if the library is modified by someone else and passed on, the recipients should know that what they have is not the original version, so that the original author's reputation will not be affected by problems that might be introduced by others.

Finally, software patents pose a constant threat to the existence of any free program. We wish to make sure that a company cannot effectively restrict the users of a free program by obtaining a restrictive license from a patent holder. Therefore, we insist that any patent license obtained for a version of the library must be consistent with the full freedom of use specified in this license.

Most GNU software, including some libraries, is covered by the ordinary GNU General Public License. This license, the GNU Lesser General Public License, applies to certain designated libraries, and is quite different from the ordinary General Public License. We use this license for certain libraries in order to permit linking those libraries into non-free programs.

When a program is linked with a library, whether statically or using a shared library, the combination of the two is legally speaking a combined work, a derivative of the original library. The ordinary General Public License therefore permits such linking only if the entire combination fits its criteria of freedom. The Lesser General Public License permits more lax criteria for linking other code with the library. We call this license the "Lesser" General Public License because it does Less to protect the user's freedom than the ordinary General Public License. It also provides other free software developers Less of an advantage over competing non-free programs. These disadvantages are the reason we use the ordinary General Public License for many libraries. However, the Lesser license provides advantages in certain special circumstances.

For example, on rare occasions, there may be a special need to encourage the widest possible use of a certain library, so that it becomes a de-facto standard. To achieve this, non-free programs must be allowed to use the library. A more frequent case is that a free library does the same job as widely used non-free libraries. In this case, there is little to gain by limiting the free library to free software only, so we use the Lesser General Public License.

In other cases, permission to use a particular library in non-free programs enables a greater number of people to use a large body of free software. For example, permission to use the GNU C Library in non-free programs enables many more people to use the whole GNU operating system, as well as its variant, the GNU/Linux operating system.

Although the Lesser General Public License is Less protective of the users' freedom, it does ensure that the user of a program that is linked with the Library has the freedom and the wherewithal to run that program using a modified version of the Library.

The precise terms and conditions for copying, distribution and modification follow. Pay close attention to the difference between a "work based on the library" and a "work that uses the library". The former contains code derived from the library, whereas the latter must be combined with the library in order to run.

GNU LESSER GENERAL PUBLIC LICENSE

TERMS AND CONDITIONS FOR COPYING, DISTRIBUTION AND MODIFICATION

0. This License Agreement applies to any software library or other program which contains a notice placed by the copyright holder or other authorized party saying it may be distributed under the terms of this Lesser General Public License (also called "this License"). Each licensee is addressed as "you".

A "library" means a collection of software functions and/or data prepared so as to be conveniently linked with application programs (which use some of those functions and data) to form executables.

The "Library", below, refers to any such software library or work which has been distributed under these terms. A "work based on the Library" means either the Library or any derivative work under copyright law: that is to say, a work containing the Library or a portion of it, either verbatim or with modifications and/or translated straightforwardly into another language. (Hereinafter, translation is included without limitation in the term "modification".)

"Source code" for a work means the preferred form of the work for making modifications to it. For a library, complete source code means all the source code for all modules it contains, plus any associated interface definition files, plus the scripts used to control compilation and installation of the library. Activities other than copying, distribution and modification are not covered by this License; they are outside its scope. The act of running a program using the Library is not restricted, and output from such a program is covered only if its contents constitute a work based on the Library (independent of the use of the Library in a tool for writing it). Whether that is true depends on what the Library does and what the program that uses the Library does.

1. You may copy and distribute verbatim copies of the Library's complete source code as you receive it, in any medium, provided that you conspicuously and appropriately publish on each copy an appropriate copyright notice and disclaimer of warranty; keep intact all the notices that refer to this License and to the absence of any warranty; and distribute a copy of this License along with the Library.

You may charge a fee for the physical act of transferring a copy, and you may at your option offer warranty protection in exchange for a fee.

2. You may modify your copy or copies of the Library or any portion of it, thus forming a work based on the Library, and copy and distribute such modifications or work under the terms of Section 1 above, provided that you also meet all of these conditions:

- a) The modified work must itself be a software library.
- b) You must cause the files modified to carry prominent notices stating that you changed the files and the date of any change.
- c) You must cause the whole of the work to be licensed at no charge to all third parties under the terms of this License.
- d) If a facility in the modified Library refers to a function or a table of data to be supplied by an application program that uses the facility, other than as an argument passed when the facility is invoked, then you must make a good faith effort to ensure that, in the event an application does not supply

such function or table, the facility still operates, and performs whatever part of its purpose remains meaningful.

(For example, a function in a library to compute square roots has a purpose that is entirely well-defined independent of the application. Therefore, Subsection 2d requires that any application-supplied function or table used by this function must be optional: if the application does not supply it, the square root function must still compute square roots.)

These requirements apply to the modified work as a whole. If identifiable sections of that work are not derived from the Library, and can be reasonably considered independent and separate works in themselves, then this License, and its terms, do not apply to those sections when you distribute them as separate works. But when you distribute the same sections as part of a whole which is a work based on the Library, the distribution of the whole must be on the terms of this License, whose permissions for other licensees extend to the entire whole, and thus to each and every part regardless of who wrote it.

Thus, it is not the intent of this section to claim rights or contest your rights to work written entirely by you; rather, the intent is to exercise the right to control the distribution of derivative or collective works based on the Library.

In addition, mere aggregation of another work not based on the Library with the Library (or with a work based on the Library) on a volume of a storage or distribution medium does not bring the other work under the scope of this License.

3. You may opt to apply the terms of the ordinary GNU General Public License instead of this License to a given copy of the Library. To do this, you must alter all the notices that refer to this License, so that they refer to the ordinary GNU General Public License, version 2, instead of to this License. (If a newer version than version 2 of the ordinary GNU General Public License has appeared, then you can specify that version instead if you wish.) Do not make any other change in these notices.

Once this change is made in a given copy, it is irreversible for that copy, so the ordinary GNU General Public License applies to all subsequent copies and derivative works made from that copy.

This option is useful when you wish to copy part of the code of the Library into a program that is not a library.

4. You may copy and distribute the Library (or a portion or derivative of it, under Section 2) in object code or executable form under the terms of Sections 1 and 2 above provided that you accompany it with the complete corresponding machine-readable source code, which must be distributed under the terms of Sections 1 and 2 above on a medium customarily used for software interchange.

If distribution of object code is made by offering access to copy from a designated place, then offering equivalent access to copy the source code from the same place satisfies the requirement to distribute the source code, even though third parties are not compelled to copy the source along with the object code.

5. A program that contains no derivative of any portion of the Library, but is designed to work with the Library by being compiled or linked with it, is called a "work that uses the Library". Such a work, in isolation, is not a derivative work of the Library, and therefore falls outside the scope of this License. However, linking a "work that uses the Library" with the Library creates an executable that is a derivative of the Library (because it contains portions of the Library), rather than a "work that uses the library". The executable is therefore covered by this License.

Section 6 states terms for distribution of such executables.

When a "work that uses the Library" uses material from a header file that is part of the Library, the object code for the work may be a derivative work of the Library even though the source code is not. Whether this is true is especially significant if the work can be linked without the Library, or if the work is itself a library. The threshold for this to be true is not precisely defined by law.

If such an object file uses only numerical parameters, data structure layouts and accessors, and small macros and small inline functions (ten lines or less in length), then the use of the object file is unrestricted, regardless of whether it is legally a derivative work. (Executables containing this object code plus portions of the Library will still fall under Section 6.)

Otherwise, if the work is a derivative of the Library, you may distribute the object code for the work under the terms of Section 6.

Any executables containing that work also fall under Section 6, whether or not they are linked directly with the Library itself.

6. As an exception to the Sections above, you may also combine or link a "work that uses the Library" with the Library to produce a work containing portions of the Library, and distribute that work under terms of your choice, provided that the terms permit modification of the work for the customer's own use and reverse engineering for debugging such modifications.

You must give prominent notice with each copy of the work that the Library is used in it and that the Library and its use are covered by this License. You must supply a copy of this License. If the work during execution displays copyright notices, you must include the copyright notice for the Library among them, as well as a reference directing the user to the copy of this License. Also, you must do one of these things:

- a) Accompany the work with the complete corresponding machine-readable source code for the Library including whatever changes were used in the work (which must be distributed under Sections 1 and 2 above); and, if the work is an executable linked with the Library, with the complete machine-readable "work that uses the Library", as object code and/or source code, so that the user can modify the Library and then relink to produce a modified executable containing the modified Library. (It is understood that the user who changes the contents of definitions files in the Library will not necessarily be able to recompile the application to use the modified definitions.)
- b) Use a suitable shared library mechanism for linking with the Library. A suitable mechanism is one that (1) uses at run time a copy of the library already present on the user's computer system, rather than copying library functions into the executable, and (2) will operate properly with a modified version of the library, if the user installs one, as long as the modified version is interface-compatible with the version that the work was made with.
- c) Accompany the work with a written offer, valid for at least three years, to give the same user the materials specified in Subsection 6a, above, for a charge no more than the cost of performing this distribution.
- d) If distribution of the work is made by offering access to copy from a designated place, offer equivalent access to copy the above specified materials from the same place.
- e) Verify that the user has already received a copy of these materials or that you have already sent this user a copy.

For an executable, the required form of the "work that uses the Library" must include any data and utility programs needed for reproducing the executable from it. However, as a special exception, the materials to be distributed need not include anything that is normally distributed (in either source or binary form) with the major components (compiler, kernel, and so on) of the operating system on which the executable runs, unless that component itself accompanies the executable.

It may happen that this requirement contradicts the license restrictions of other proprietary libraries that do not normally accompany the operating system. Such a contradiction means you cannot use both them and the Library together in an executable that you distribute.

7. You may place library facilities that are a work based on the Library side-by-side in a single library together with other library facilities not covered by this License, and distribute such a combined library, provided that the separate distribution of the work based on the Library and of the other library facilities is otherwise permitted, and provided that you do these two things:

- a) Accompany the combined library with a copy of the same work based on the Library, uncombined with any other library facilities. This must be distributed under the terms of the Sections above.
- b) Give prominent notice with the combined library of the fact that part of it is a work based on the Library, and explaining where to find the accompanying uncombined form of the same work.

8. You may not copy, modify, sublicense, link with, or distribute the Library except as expressly provided under this License. Any attempt otherwise to copy, modify, sublicense, link with, or distribute the Library is void, and will automatically terminate your rights under this License. However, parties who have received copies, or rights, from you under this License will not have their licenses terminated so long as such parties remain in full compliance.

9. You are not required to accept this License, since you have not signed it. However, nothing else grants you permission to modify or distribute the Library or its derivative works. These actions are prohibited by law if you do not accept this License. Therefore, by modifying or distributing the Library (or any work based on the Library), you indicate your acceptance of this License to do so, and all its terms and conditions for copying, distributing or modifying the Library or works based on it.

10. Each time you redistribute the Library (or any work based on the Library), the recipient automatically receives a license from the original licensor to copy, distribute, link with or modify the Library subject to these terms and conditions. You may not impose any further restrictions on the recipients' exercise of the rights granted herein.

You are not responsible for enforcing compliance by third parties with this License.

11. If, as a consequence of a court judgment or allegation of patent infringement or for any other reason (not limited to patent issues), conditions are imposed on you (whether by court order, agreement or otherwise) that contradict the conditions of this License, they do not excuse you from the conditions of this License. If you cannot distribute so as to satisfy simultaneously your obligations under this License and any other pertinent obligations, then as a consequence you may not distribute the Library at all. For example, if a patent license would not permit royalty-free redistribution of the Library by all those who receive copies directly or indirectly through you, then the only way you could satisfy both it and this License would be to refrain entirely from distribution of the Library.

If any portion of this section is held invalid or unenforceable under any particular circumstance, the balance of the section is intended to apply, and the section as a whole is intended to apply in other circumstances.

It is not the purpose of this section to induce you to infringe any patents or other property right claims or to contest validity of any such claims; this section has the sole purpose of protecting the integrity of the free software distribution system which is implemented by public license practices. Many people have made generous contributions to the wide range of software distributed through that system in reliance on consistent application of that system; it is up to the author/donor to decide if he or she is willing to distribute software through any other system and a licensee cannot impose that choice. This section is intended to make thoroughly clear what is believed to be a consequence of the rest of this License.

12. If the distribution and/or use of the Library is restricted in certain countries either by patents or by copyrighted interfaces, the original copyright holder who places the Library under this License may add an explicit geographical distribution limitation excluding those countries, so that distribution is permitted only in or among countries not thus excluded. In such case, this License incorporates the limitation as if written in the body of this License.

13. The Free Software Foundation may publish revised and/or new versions of the Lesser General Public License from time to time. Such new versions will be similar in spirit to the present version, but may differ in detail to address new problems or concerns.

Each version is given a distinguishing version number. If the Library specifies a version number of this License which applies to it and "any later version", you have the option of following the terms and conditions either of that version or of any later version published by the Free Software Foundation. If the Library does not specify a license version number, you may choose any version ever published by the Free Software Foundation.

14. If you wish to incorporate parts of the Library into other free programs whose distribution conditions are incompatible with these, write to the author to ask for permission. For software which is copyrighted by the Free Software Foundation, write to the Free Software Foundation; we sometimes make exceptions for this. Our decision will be guided by the two goals of preserving the free status of all derivatives of our free software and of promoting the sharing and reuse of software generally.

NO WARRANTY

15. BECAUSE THE LIBRARY IS LICENSED FREE OF CHARGE, THERE IS NO WARRANTY FOR THE LIBRARY, TO THE EXTENT PERMITTED BY APPLICABLE LAW.

EXCEPT WHEN OTHERWISE STATED IN WRITING THE COPYRIGHT HOLDERS AND/OR OTHER PARTIES PROVIDE THE LIBRARY "AS IS" WITHOUT WARRANTY OF ANY KIND, EITHER EXPRESSED OR IMPLIED, INCLUDING, BUT NOT LIMITED TO, THE IMPLIED WARRANTIES OF MERCHANTABILITY AND FITNESS FOR A PARTICULAR PURPOSE. THE ENTIRE RISK AS TO THE QUALITY AND PERFORMANCE OF THE LIBRARY IS WITH YOU. SHOULD THE LIBRARY PROVE DEFECTIVE, YOU ASSUME THE COST OF ALL NECESSARY SERVICING, REPAIR OR CORRECTION.

16. IN NO EVENT UNLESS REQUIRED BY APPLICABLE LAW OR AGREED TO IN WRITING WILL ANY COPYRIGHT HOLDER, OR ANY OTHER PARTY WHO MAY MODIFY AND/OR REDISTRIBUTE THE LIBRARY AS PERMITTED ABOVE, BE LIABLE TO YOU FOR DAMAGES, INCLUDING ANY GENERAL, SPECIAL, INCIDENTAL OR CONSEQUENTIAL DAMAGES ARISING OUT OF THE USE OR INABILITY TO USE THE LIBRARY (INCLUDING BUT NOT LIMITED TO LOSS OF DATA OR DATA BEING RENDERED INACCURATE OR LOSSES SUSTAINED BY YOU OR THIRD PARTIES OR A FAILURE OF THE LIBRARY TO OPERATE WITH ANY OTHER SOFTWARE), EVEN IF SUCH HOLDER OR OTHER PARTY HAS BEEN ADVISED OF THE POSSIBILITY OF SUCH DAMAGES.

END OF TERMS AND CONDITIONS

How to Apply These Terms to Your New Libraries

If you develop a new library, and you want it to be of the greatest possible use to the public, we recommend making it free software that everyone can redistribute and change. You can do so by permitting redistribution under these terms (or, alternatively, under the terms of the ordinary General Public License).

To apply these terms, attach the following notices to the library. It is safest to attach them to the start of each source file to most effectively convey the exclusion of warranty; and each file should have at least the "copyright" line and a pointer to where the full notice is found.

<one line to give the library's name and a brief idea of what it does.>
 Copyright (C) <year> <name of author>
 This library is free software; you can redistribute it and/or modify it under the terms of the GNU Lesser General Public License as published by the Free Software Foundation; either version 2.1 of the License, or (at your option) any later version.
 This library is distributed in the hope that it will be useful, but WITHOUT ANY WARRANTY; without even the implied warranty of MERCHANTABILITY or FITNESS FOR A PARTICULAR PURPOSE. See the GNU Lesser General Public License for more details.

You should have received a copy of the GNU Lesser General Public License along with this library; if not, write to the Free Software Foundation, Inc., 59 Temple Place, Suite 330, Boston, MA 02111-1307 USA

Also add information on how to contact you by electronic and paper mail.

You should also get your employer (if you work as a programmer) or your school, if any, to sign a "copyright disclaimer" for the library, if necessary. Here is a sample; alter the names:

Yoyodyne, Inc., hereby disclaims all copyright interest in the library `Frob' (a library for tweaking knobs) written by James Random Hacker. <signature of Ty Coon>, 1 April 1990 Ty Coon, President of Vice

Accessories

Gigaset handsets

Upgrade your Gigaset to a cordless PABX:

Gigaset C47H handset

- ◆ Illuminated graphical colour display (65k colours)
- ◆ Illuminated keypad
- ◆ Handsfree talking
- ◆ Polyphonic ringer tones
- ◆ Directory for around 150 entries
- ◆ SMS (precondition: CLIP must be enabled)
- ◆ Headset socket
- ◆ Room monitor
- ◆ www.siemens.com/gigasetC47H



Gigaset S67H handset

- ◆ HDSP ready
- ◆ Illuminated graphical colour display (65k colours)
- ◆ Illuminated keypad
- ◆ Handsfree talking
- ◆ Polyphonic ringer tones
- ◆ Directory for around 250 entries
- ◆ Picture CLIP
- ◆ SMS (precondition: CLIP must be enabled)
- ◆ Headset socket
- ◆ Room monitor

www.siemens.com/gigasetS67H



Gigaset SL37H handset

- ◆ HDSP ready
- ◆ Illuminated graphical colour display (65k colours)
- ◆ Illuminated keypad
- ◆ Handsfree talking
- ◆ Polyphonic ringer tones
- ◆ Directory for around 250 entries
- ◆ Picture CLIP
- ◆ SMS (precondition: CLIP must be enabled)
- ◆ PC interface, e.g. for managing directory entries, ringer tones and screensavers
- ◆ Headset socket
- ◆ Bluetooth
- ◆ Room monitor
- ◆ Walky-talky function

www.siemens.com/gigasetSL37H



Gigaset S45 handset

- ◆ Illuminated colour display (4096 colours)
- ◆ Illuminated keypad
- ◆ Handsfree talking
- ◆ Polyphonic ringer tones
- ◆ Directory for around 150 entries
- ◆ SMS (precondition: CLIP must be enabled)
- ◆ Headset socket
- ◆ Room monitor

www.siemens.com/gigaset



Gigaset repeater

The Gigaset repeater can be used to increase the reception range of your Gigaset handset to the base station.

www.siemens.com/gigasetrepeater



Gigaset HC450 – door intercom for cordless phones

- ◆ Use the intercom from your cordless phone – no need for a fixed home phone
- ◆ Intuitive user functions using the display keys (open door, switch on entry light)
- ◆ Simple to configure using the handset menu
- ◆ Forward to outside phone numbers (intercom feature)
- ◆ Simple to install and register with the Gigaset system
- ◆ Replaces existing call button – no further cable is needed
- ◆ Supports the existing doorbell and standard door opener
- ◆ Configuration options for the second ringer key (separate intercom call, activating interior lighting, or function such as first ringer key)

www.siemens.com/GigasetHC450



All accessories are available from your mobile phone retailer.



Only use original accessories. This will avoid possible health risks and damage to property, and also ensure that all the relevant regulations are complied with.

Glossary

A

ADSL

Asymmetric Digital Subscriber Line
Special form of **DSL**.

ALG

Application Layer Gateway

NAT control mechanism of a router.

Many routers with integrated NAT use ALG. ALG lets the data packets in a VoIP connection pass and adds the public IP address of the secure private network.

The router's ALG should be deactivated if the VoIP provider offers a STUN server or an outbound proxy.

See also: **Firewall, NAT, Outbound proxy, STUN**.

Authentication

Restriction of access to a network/service by use of an ID and password to log in.

Automatic ringback

See **Ringback when the number is busy**.

B

Block dialling

Enter the complete phone number, and correct it if necessary. Then pick up the receiver or press the handsfree key to dial the phone number.

Broadband Internet access

See **DSL**.

Buddy

Subscriber with whom you exchange brief messages on the Internet in real time (chatting).

See also: **Instant messaging**.

C

Call waiting

CW

VoIP provider feature. A beep during a call indicates that another caller is waiting. You can accept or reject the second call. You can activate/deactivate the feature.

Call forwarding

CF

Automatic forwarding of a call to a different telephone number. There are three kinds of call forwarding:

- CFU, Call Forwarding Unconditional
- CFB, Call Forwarding Busy
- CFNR, Call Forwarding No Reply

Chatting

Form of communication on the Internet. During a chat, brief messages are exchanged between the communicating parties in real time. Chatting in this sense is understood to be a written form of communication.

Client

Application that requests a service from a server.

Codec

Coder/decoder

Codec is a procedure that digitises and compresses analogue voice before it is sent via the Internet and decodes – i.e. translates into analogue voice – digital data when voice packets are received. There are different codecs, with differing degrees of compression, for instance.

Both parties involved in the telephone connection (caller/sender and recipient) must use the same codec. This is negotiated between the sender and the recipient when establishing a connection.

The choice of codec is a compromise between voice quality, transmission speed and the necessary bandwidth. A high level of compression, for example, means that the bandwidth required for each voice connection is low. However, it also means that the time needed to compress/decompress the data is greater, which increases execution time for data in the network and thus impairs voice quality. The time required increases the delay between the sender speaking and the recipient hearing what has been said.

COLP / COLR

Connected Line Identification Presentation/Restriction

Service characteristic of a VoIP connection for outgoing calls.

COLP displays the phone number accepting the call on the calling party's display unit.

The number of the party accepting the call is different to the dialled number, e.g. if the call is forwarded or transferred.

The called party can use COLR (Connected Line Identification Restriction) to prevent the number from appearing on the calling party's display.

Consultation call

You are on a call. With a consultation call, you interrupt the conversation briefly to establish a connection to another participant. If you terminate the connection to this participant immediately, then this is a consultation call. If you switch to and fro between the first and second participants, it is called **Toggleing**.

CW

Call Waiting

See **Call waiting**.

D

DHCP

Dynamic Host Configuration Protocol

Internet protocol that handles the automatic assignment of **IP addresses** to **Network subscribers**. The protocol is made available in the network by a server. A DHCP server can be a router for example.

The phone contains a DHCP client. A router that contains a DHCP server can assign the IP addresses for the phone automatically from a defined address block. The dynamic assignment means that several **Network subscribers** can share one IP address, although they use it alternately and not simultaneously.

With some routers you can specify that the IP address for the phone is never changed.

Displayed name

VoIP provider feature. You can specify any name that is to be shown to the other party during a call instead of your phone number.

DMZ (Demilitarised Zone)

DMZ describes a part of a network that is outside the firewall.

A DMZ is set up, as it were, between a network you want to protect (e.g. a LAN) and a non-secure network (e.g. the Internet). A DMZ permits unrestricted access from the Internet to only one or a few network components, while the other network components remain secure behind the firewall.

DNS

Domain Name System

Hierarchical system that permits the assignment of **IP addresses** to **Domain names** that are easier to note. This assignment has to be managed by a local DNS server in each (W)LAN. The local DNS server determines the IP address, if necessary by enquiring about superordinate DNS servers and other local DNS servers on the Internet.

You can specify the IP address of the primary/secondary DNS server.

See also: **DynDNS**.

Domain name

Name of one (of several) Web server on the Internet (e.g. Siemens Home) The domain name is assigned to the relevant IP address by DNS.

DSCP

Differentiated Service Code Point

See **Quality of Service (QoS)**.

DSL

Digital Subscriber Line

Data transfer technology that allows Internet access with, for e.g., **1.5 Mbps** over a conventional telephone line. Preconditions: DSL modem and the appropriate service offered by the Internet provider.

DSLAM

Digital Subscriber Line Access Multiplexer

The DSLAM is a switch cabinet in an exchange at which all subscriber connectors converge.

DTMF

Dual Tone Multi-Frequency

Another description for dual tone multi-frequency dialling.

Dynamic IP address

A dynamic IP address is assigned to a network component automatically via **DHCP**. The dynamic IP address for a network component can change every time it registers or at certain time intervals.

See also: **Static IP address**

DynDNS

Dynamic DNS

Domain names and IP addresses are realised via **DNS**. For **Dynamic IP addresses** this service is now enhanced with "Dynamic DNS" (DynDNS). This permits the use of a network component with a dynamic IP address as a **Server** on the **Internet**. DynDNS ensures that a service can always be addressed on the Internet under the same **Domain name** irrespective of the current IP address.

E

ECT

Explicit Call Transfer

Participant A calls participant B. He puts the connection on hold and calls participant C. Rather than connect everyone in a three-party conference, A now transfers participant B to C and hangs up.

EEPROM

Electrically Erasable Programmable Read Only Memory

Memory building block in your phone with fixed data (e.g. default and customised settings) and data saved automatically (e.g. entries to the list of callers).

Ethernet network

Wired **LAN**.

F

Firewall

You can use a firewall to protect your network against unauthorised external access. This involves combining various measures and technologies (hard and/or software) to control the flow of data between a private network you wish to protect and an unprotected network (e.g. the Internet).

See also: **NAT**.

Firmware

Device software in which basic information is saved for the functioning of a device. A new version of the firmware can be loaded into the device's memory (firmware update) to correct errors or update the device software.

Flat rate

Billing system for an **Internet** connection. The Internet provider charges a set monthly fee. There are no additional charges for the duration of the connection or number of connections.

Fragmentation

Data packets that are too big are split into smaller packets (fragments) before they are transferred. They are put together again when they reach the recipient (defragmented).

Full duplex

Data transfer mode in which data can be sent and received at the same time.

G**G.711 a law, G.711 μ law**

Standard for a **Codec**.

G.711 delivers a very good voice quality that corresponds to that in the ISDN fixed line. As there is little compression, the necessary bandwidth is around 64 kbit/s per voice connection, but the delay caused by coding/decoding is only 0.125 ms.

"a law" describes the European standard and " μ law" describes the North American/Japanese equivalent.

G.722

Standard for a **Codec**.

G.722 is a **broadband** language codec with a bandwidth of 50 Hz to 7 kHz, a net transfer rate of 64 kbit/s per language connection and integrated speech pause recognition and comfort noise generation (silence suppression).

G.722 delivers very good voice quality. A higher sampling rate provides clearer and better voice quality than other codecs and enables a speech tone in High Definition Sound Performance (HDSP).

G.726

Standard for a **Codec**.

G.726 delivers a good voice quality. It is inferior to the quality with codec **G.711** but better than with **G.729**.

G.729A/B

Standard for a **Codec**.

The voice quality is rather lower with G.729A/B. As a result of the high level of compression, the necessary bandwidth is only around 8 kbit/s per voice connection, but the delay is around 15 mins.

Gateway

Connects two different **Networks**, e.g. a router as an Internet gateway.

For phone calls from **VoIP** to the telephone network, a gateway has to be connected to the IP network and the telephone network (gateway/VoIP provider). It forwards calls from VoIP to the telephone network as required.

Gateway Provider

See **SIP provider**.

Global IP Address

See **IP address**.

GSM

Global System for Mobile Communication

Originally, European standard for mobile networks. GSM can now be described as a worldwide standard. In the USA and Japan national standards are now more frequently supported than in the past.

H

Headset

Combination of microphone and headphone. A headset makes handsfree talking more comfortable. There are headsets available that are connected to the handset by a cable.

HTTP Proxy

Server via which the **Network subscribers** can process their Internet traffic.

Hub

Uses one **Infrastructure network** to connect several **Network subscribers**. All data sent to the hub by one network subscriber is forwarded to all network subscribers.

See also: **Gateway, Router**.

I

IEEE

Institute of Electrical and Electronics Engineers

International body that defines standards in electronics and electro-technology, concerned in particular with the standardisation of LAN technology, transmission protocols, data transfer rate and wiring.

Infrastructure network

Network with central structure: all **Network subscribers** communicate via a central **Router**.

Instant messaging

Service that uses a client program to allow chatting in real time, i.e. to send brief messages to other subscribers on the Internet.

Internet

Global **WAN**. A series of protocols have been defined for exchanging data, known by the name TCP/IP.

All **Network subscribers** are identifiable via their **IP address**. **DNS** assigns a **Domain name** to the **IP address**.

Important services on the Internet include the World Wide Web (WWW), e-mail, file transfer and discussion forums.

Internet Service Provider

Enables access to the Internet for a fee.

IP (Internet Protocol)

TCP/IP protocol on the **Internet**. IP is responsible for addressing subscribers in a **Network** using **IP addresses** and routes data from the sender to the recipient. IP determines the paths (routing) along which the data packets travel.

IP address

A unique address for a network component within a network based on the TCP/IP protocols (e.g. LAN, Internet). On the **Internet**, domain names are usually assigned instead of IP addresses. **DNS** assigns the corresponding IP address to the domain name.

The IP address has four parts (decimal numbers between 0 and 255) separated by full stops (e.g. 230.94.233.2).

The IP address is made up of the network number and the number of the **Network subscribers** (e.g. phone). Depending on the Subnet mask, the front one, two or three parts make up the network number and the rest of the IP address addresses the network component. The network number of all the components in any one network must be identical.

IP addresses can be assigned automatically with DHCP (dynamic IP addresses) or manually (static IP addresses).

See also: **DHCP**.

IP pool range

Range of IP addresses that the DHCP server can use to assign dynamic IP addresses.

L

LAN

Local Area Network

Network with a restricted physical range. A LAN can be wireless (WLAN) and/or wired.

Local IP address

The local or private IP address is the address for a network component in the local network (LAN). The network operator can assign any address he or she wants. Devices that act as a link from a local network to the Internet (gateway or router) have a public and a private IP address.

See also **IP address**.

Local SIP Port

See **SIP port/Local SIP port**.

M

MAC address

Media Access Control Address

Hardware address by means of which each network device (e.g. network card, switch, phone) can be uniquely identified worldwide. It consists of 6 parts (hexadecimal numbers) separated by a "-" (e.g. 00-90-65-44-00-3A).

The MAC address is assigned by the manufacturer and cannot be changed.

Mbps

Million bits per second

Unit of the transmission speed in a network.

MRU

Maximum Receive Unit

Defines the maximum user data volume within a data packet.

MTU

Maximum Transmission Unit

Defines the maximum length of a data packet that can be carried over the network at a time.

Music on hold

Music on hold

Music that is played while you are on a **Consultation call** or **Toggling**. The waiting participant hears music while on hold.

N

NAT

Network Address Translation

Method for converting (private) **IP address**s to one or more (public) IP addresses. NAT enables the IP addresses of **Network subscribers** (e.g. VoIP telephones) in a **LAN** to be concealed behind a shared IP address for the **Router** on the **Internet**.

VoIP telephones behind a NAT router cannot be reached by VoIP servers (on account of the private IP address). In order to "get around" NAT, it is possible to use (alternatively) **ALG** in the router, **STUN** in the VoIP telephone, or for the VoIP provider to use an **Outbound proxy**.

If an outbound proxy is made available you must allow for this in the VoIP settings for your phone.

Network

Group of devices. Devices can be connected in either wired or wireless mode.

Networks can also differ in range and structure:

- Range: local networks (**LAN**) or wide-area networks (**WAN**)
- Structure: **Infrastructure network** or ad-hoc network

Network subscribers

Devices and computers that are connected to each other in a network, e.g. servers, PCs and phones.

O

Outbound proxy

Alternative NAT control mechanism to STUN and ALG.

Outbound proxies are implemented by the VoIP provider in firewall/NAT environments as an alternative to **SIP proxy server**. They control data traffic through the firewall.

Outbound proxy and STUN servers should not be used simultaneously.

See also: **STUN** and **NAT**.

P

Paging (handset search)

A base station function to locate registered handsets. The base station establishes a connection to every registered handset. The handsets start to ring. Paging is activated by briefly pressing the button on the base station and is deactivated by briefly pressing the same button again.

PIN

Personal Identification Number

Protects against unauthorised use. When the PIN is activated a number combination has to be entered in order to access a protected area.

You can protect your base station configuration data with a system PIN (4-digit number combination).

Port

Data is exchanged between two applications in a **Network** via a port.

Port forwarding

The Internet gateway (e.g. your router) forwards data packets from the **Internet** that are directed to a certain **Port** to the port concerned. This allows servers in the **LAN** to offer services on the Internet without you needing a public IP address.

Port number

Indicates a specific application of **Network subscribers**. Depending on the setting in the **LAN**, the port number is permanently assigned or else it is newly assigned with each access.

The combination of **IP address/Port** number uniquely identifies the recipient or sender of a data packet within a network.

Pre-dialling

See **Block dialling**.

Private IP address

See **Public IP address**.

Protocol

Describes the agreements for communicating within a **Network**. It contains rules for opening, administering and closing a connection, about data formats, time frames and possible error handling.

Proxy/Proxy server

Computer program that controls the exchange of data between **Client** and **Server** in computer networks. If the phone sends a query to the VoIP server, the proxy acts as a server towards the phone and as a client towards the server. A proxy is addressed via **IP address/Domain name** and **Port**.

Public IP address

The public IP address is the address for a network component on the Internet. It is assigned by the Internet Service Provider. Devices that act as a link from a local network to the Internet (gateway, router) have a public and a local IP address.

See also: **IP address, NAT**

Q**Quality of Service (QoS)**

Describes the Quality of Service in communication networks. Differentiations are made between various Quality of Service classes.

QoS influences the flow of data packets on the Internet, e.g. by prioritising data packets, reserving bandwidth and data packet optimisation.

In VoIP networks, QoS influences the voice quality. If the whole infrastructure (router, network server etc.) has QoS, the voice quality is better, i.e. fewer delays, less echoing, less crackling.

R

RAM

Random Access Memory

Memory in which you have reading and storage rights. Items such as melodies and screen pictures are saved in the RAM after you have loaded them onto the phone via the Web configurator.

Registrar

The registrar manages the **Network subscribers** current IP addresses. When you register with your VoIP provider, your current IP address is saved on the registrar. This means you can also be reached when on the move.

Ringback when the call is not answered

= CCNR (Completion of Calls on No Reply). If a participant does not respond when called, a caller can arrange an automatic ringback. As soon as the destination phone has completed a call and is free again, the caller is rung back. This feature must be supported by the exchange. The ringback request is automatically cancelled after about 2 hours (depending on the VoIP provider).

Ringback when the number is busy

= CCBS (Completion of Calls to Busy Subscriber). If a caller hears the busy tone, he or she can activate the ringback function. As soon as the connection is free the caller is rung back. As soon as the caller lifts his receiver the connection is made automatically.

ROM

Read Only Memory

A type of memory that can only be read, as opposed to RAM which can be both read and written.

Router

Routes data packets within a network and between different networks via the quickest route. Can connect **Ethernet networks** and WLAN. Can be a **Gateway** to the Internet.

Routing

Routing is the transfer of data packets to another subscriber in your network. On its way to the recipient, the data packets are sent from one router to the next until it reaches its destination.

If data packets were not forwarded in this way, a network like the Internet would not be possible. Routing connects the individual networks to this global system.

A router is a part of this system; it transfers data packets both within a local network and from one network to the next. Transfer of data from one network to another is performed on the basis of a common protocol.

RTP

Realtime Transport Protocol

Global standard for transferring audio and video data. Often used in conjunction with UDP. In this case, RTP packets are embedded in UDP packets.

RTP port

(Local) **Port** that is used to send and receive voice data packets for VoIP.

S

Server

Provides a service to other **Network subscribers (Clients)**. The term can indicate a computer/PC or an application. A server is addressed via **IP address/Domain name** and **Port**.

SIP (Session Initiation Protocol)

Signalling protocol independent of voice communication. Used for establishing and ending a call. It is also possible to define parameters for voice transmission.

SIP address

See **URI**.

SIP port/Local SIP port

(Local) **Port** which is used to send and receive SIP signalling data for VoIP.

SIP provider

See **VoIP provider**.

SIP proxy server

IP address of your VoIP provider's gateway server.

Static IP address

A static IP address is assigned to a network component manually during network configuration. Unlike a **Dynamic IP address** a static (fixed) IP address never changes.

STUN

Simple Transversal of UDP over NAT

NAT control mechanism.

STUN is a data protocol for VoIP telephones. STUN replaces the private IP address in the data packets of the VoIP telephone with the public address of the secure private network. To control data transfer, a STUN server is also required on the Internet. STUN cannot be implemented with symmetric NATs.

See also: **ALG, Firewall, NAT, Outbound proxy**.

Subnet

Segment of a **Network**.

Subnet mask

IP addresses consist of a fixed line number and a variable subscriber number. The network number is identical for all **Network subscribers**. The proportion of the IP address made up of the network number is determined in the subnet mask. In the subnet mask 255.255.255.0, for e.g., the first three parts of the IP address are the network number and the last part the subscriber number.

Symmetric NAT

A symmetric NAT assigns different external IP addresses and port numbers to the same internal IP addresses and port numbers – depending on the external target address.

T

TCP

Transmission Control Protocol

Transport protocol. Session-based transmission protocol: it sets up, monitors and terminates a connection between sender and recipient for transporting data.

TLS

Transport Layer Security

Protocol for encrypting data transfers on the Internet. TLS is a superordinated **Transport protocol**.

Toggleing

Toggleing allows you to switch between two callers or between a conference call and an individual caller without allowing the waiting caller to screen the call.

Transfer rate

Speed at which data is transferred in the **WAN** or **LAN**. The transfer rate is measured in data units per unit of time (Mbit/s).

Transport protocol

Controls data transport between communication partners (applications).

See also: **UDP**, **TCP**, **TLS**.

U

UDP

User Datagram Protocol

Transport protocol. Unlike **TCP**, **UDP** is a non session-based protocol. It does not establish a fixed connection. The data packets (datagrams) are sent as broadcast. The recipient is solely responsible for making sure the data is received. The sender is not notified about whether it is received.

URI

Uniform Resource Identifier

Character sequence for identifying resources (e.g. e-mail recipient, <http://siemens.com>, files).

On the **Internet** URIs are used as a uniform identification for resources. URIs are also described as SIP addresses.

URIs can be entered in the phone as a number. By dialling a URI you can call an Internet subscriber with VoIP equipment.

URL

Universal Resource Locator

Globally unique address of a domain on the **Internet**.

A URL is a subtype of **URI**. URLs identify a resource by its location on the **Internet**. For historical reasons the term is often used as a synonym for URI.

User identification

Name/number combination for access, e.g. to your VoIP account.

V

Voice codec

See **Codec**.

VoIP

Voice over Internet Protocol

Telephone calls are no longer placed and transmitted over the telephone network but over the **Internet** (or other IP networks).

VoIP provider

A VoIP, SIP or **Gateway Provider** is an Internet service provider that provides a **Gateway** for Internet telephony. As the phone works with the SIP standard, your provider must support the SIP standard.

The provider routes calls from VoIP to the telephone network (analogue, ISDN and mobile radio) and vice versa.

W

WAN

Wide Area Network

Wide-area network that is unrestricted in terms of area (e.g. **Internet**).

Index

A

Access protection 114

Access to Web configurator
 from other networks 131

Accessories 186

Account name (e-mail) 154

Acknowledge tones 111

Activate
 annex B for G.729 143
 answer machine from external
 location 80
 network mailbox 94, 151

Activating
 advisory tones 111
 answer machine 71
 auto answer 109
 handset 1, 37
 handsfree talking 36
 keypad lock 37
 listening in 103
 repeater mode 115
 room monitor 104
 two-way recording 76

Address assignment (IP address) . . . 130

ADSL 189

Advisory tones 111

Alarm clock 112

Alert tone
 activating/deactivating 111

ALG 189

Alternative DNS server
 (Web configurator) 131

Announce only mode
 (ans. mach.) 71

Announcement (answer machine) . . . 73

Anonymous calling 44

Answer and record mode
 (ans. mach.) 71

Answer machine 71
 activating/deactivating 71
 assigning receive numbers 145
 define for fast access 95
 deleting messages 75
 list 59
 playing back messages 74
 recording announcement/
 notification 73

 remote operation 79
 scrolling back 75
 scrolling forward 75

Application Layer Gateway (ALG) . . . 189

Application signal (recall key) 147

Application type (recall key) 147

Area code
 dialling automatically 148
 enter own area code 148

Area code predialling
 activating/deactivating 148

Area codes 14
 extra codes 14
 local area code 14
 own dialling code 14

Assigning send number to handset . . 144

Asymmetric Digital Subscriber Line . . 189

Attaching the belt clip 23

Audio (DTMF signalling) 146

Authentication 189

Authorisation 172

Auto answer 109
 activating/deactivating 109

Auto-configuration code 18

Automatic
 call acceptance 33
 version check 161

Automatic configuration
 e. VoIP connection 18, 134

Available codecs 142

Away from computer (messenger) . . . 86

B

Base station
 activating/deactivating eco mode . . 24
 changing system PIN 114
 checking service information 171
 connecting 15
 connecting with fixed line network . 16
 connecting with mains power
 supply 16
 connecting with router 17
 operating on PABX 122
 power consumption 175
 reducing power consumption 24
 reducing transmission power 24
 restoring to factory settings 114
 setting 114
 setting default connection . . 116, 144
 setting up 14

- updating firmware 116, 159
- wall mounting 215
- Base station power consumption
 - reducing. 24
- Battery
 - charging. 1, 13
 - display 1, 13
 - icon 1, 13
 - inserting 11
 - recommended batteries 174
 - tone. 111
- Beep 111
- Block dialling 189
- Broadband Internet access 189
- Broadband language codec G.722 . . 140
- Broadband speech codec 193
- Buddy 84, 189
 - calling 92
 - checking information 89
 - messages 90
 - status changes 88
- Buddy list (messenger) 84
 - opening 87
- Busy (messenger) 86
- Buttons (Web configurator) 128

C

Call

- accepting 33
- connect participant to listen in . . . 103
- disconnecting (toggling) 46, 48
- ending 32
- external 35
- internal 101
- number/name display 33
- picking up from answer machine . . . 76
- rejecting external 102
- transferring (connecting) 101
- two-way recording 76
- Call acceptance 77
- Call display 34
 - fixed line network. 34
 - name from online directory. . . 34, 155
 - VoIP. 34
- Call duration display. 60
- Call forwarding 189
 - fixed line network. 45
 - Gigaset.net. 146
 - VoIP (handset) 47
 - VoIP (Web configurator) 146

- Call screening during recording 77
- Call waiting 189, 190
 - accepting/rejecting (fixed line
 - network). 46
 - accepting/rejecting (VoIP). 48
 - activating/deactivating (fixed line
 - network). 45
 - activating/deactivating (VoIP) 47
 - internal call 102
- Call-by-call list. 49
 - key 1
- Call-by-call numbers 49, 60
- Calling
 - anonymously. 44
 - entering IP address 32
 - external. 30
 - from classified directory. 55
 - from online directory 55
 - Gigaset.net 42, 43
 - internal 101
 - via VoIP/fixed line network 30
- Calling Line Identification 33
- Calling Line Identification
 - Presentation. 33
- Calls list 58
- Cancelling
 - dialling 32
 - operation 38, 39, 128
 - ring back (fixed line network) 46
- Care of the telephone 163
- CF, see Call forwarding
- Changing
 - dialling mode 122
 - earpiece volume 109
 - handsfree volume 109
 - internal number. 100, 156
 - system PIN 114
 - to summertime 161
- Character set table, see
 - Special characters
- Charge saving function (remote
 - operation) 77
- Charge status display 1
 - battery 13
- Charging cradle
 - connecting 214
 - wall mounting. 214
- Chatting 84, 190
 - with buddies 89

- Checking
 - EEPROM version 162
 - firmware version 162
 - service information 171
 - Classified directory 53
 - CLI 33
 - Client 190
 - CLIP 33
 - Codecs 190
 - available codecs 142
 - Colour scheme (display) 106
 - COLP 35, 190
 - COLR 35, 190
 - Conference 102
 - Conference call
 - VoIP 48
 - Configuration
 - via PC 124
 - VoIP connection (automatic) 134
 - Configuring
 - Network mailbox 94
 - VoIP connection (handset) 119
 - VoIP connection (Web config.) . . . 132
 - Confirmation tone 111
 - Connected Line
 - Identification Presentation . . 35, 190
 - Connecting
 - charging cradle 12
 - PC with Web configurator 124
 - to the Web configurator 124, 125
 - Connection
 - activating (VoIP) 139
 - Internet (troubleshooting) 22
 - name/provider (Web config.) 132
 - selecting (line suffix) 31
 - to Gigaset.net 140
 - to messenger server 85
 - Connection assistant
 - starting (getting started) 19
 - Connection name
 - fixed line network 139
 - VoIP 134
 - Connection socket for headset 1, 24
 - Connection type
 - selecting (display key) 31
 - selecting (talk key) 30
 - Consultation call 190
 - ending 102
 - external (fixed line network) 46
 - external (VoIP) 48
 - internal 38, 102
 - Contrast (display) 106
 - Control key 1
 - functions 37
 - Correcting incorrect entries 39
 - Cost control 9, 60
 - defining dialling plans 149
 - Customer Care 172
 - CW 190
- D**
- Data packets, fragmentation 193
 - Data server for firmware update . . . 159
 - Date
 - setting manually 13
 - transferring from time server 161
 - Deactivating
 - advisory tones 111
 - answer machine 71
 - auto answer 109
 - handset 1, 37
 - handsfree talking 36
 - internal listening in 103
 - keypad lock 37
 - listening in 103
 - network mailbox 94, 151
 - repeater mode 115
 - room monitor 105
 - two-way recording 76
 - Default settings
 - handset 113
 - Deleting
 - announcement for answer
 - machine 74
 - characters 39
 - messages 75
 - Demilitarised Zone 191
 - De-registering
 - from Web configurator 126
 - handset from base station 99
 - Describes 197
 - Destination number (room monitor) 104
 - DHCP 191, 192
 - Dialling
 - cancelling 32
 - directory 51
 - IP address 32
 - mode 122
 - with quick dial 52
 - Dialling plans 9, 60, 149

- activating/deactivating 151
- defining 150
- deleting 151
- for emergency numbers 151
- Differentiated Service Code Point . . . 191
- Digital Subscriber Line 191
- Digital Subscriber Line
 - Access Multiplexer 191
- Directory 49
 - copying number 53
 - deleting (Web configurator) 158
 - editing via PC 157
 - Gigaset.net 40
 - loading from PC 158
 - opening 37, 38, 53
 - order of entries 50
 - saving entry 50
 - saving numbers from SMS 65
 - searching for an entry 54
 - selecting entry 51
 - sending entry/list to handset 52
 - storing sender's SMS number 65
 - transferring to/from PC 157
 - using to enter numbers 53
- Display
 - backlight 107
 - call duration 60
 - caller's number (CLI/CLIP) 33
 - changing display language 106
 - colour scheme/contrast 106
 - in idle status 1
 - memory 52
 - name from online directory . . . 34, 155
 - screen picture 107
 - setting 106
 - wrong language 106
- Display keys 1, 38
 - assigning 108
 - change configuration 108
- Displayed name (VoIP) 136, 191
- Disposal
 - electrical and electronic devices 8
- DMZ 191
- DNS 191
- DNS server
 - alternative (Web configurator) . . . 131
 - preferred (handset) 121
 - preferred (Web configurator) 131
- Do not disturb (messenger) 86
- Domain 136
- Domain name 191
- Domain Name System 191
- Draft message list (SMS) 63
- DSCP 191
- DSL 191
- DSLAM 191
- DTMF (tone dialling) 123
- DTMF-reminder for VoIP 146
- Dynamic DNS 192
- Dynamic Host Configuration
 - Protocol 191
- Dynamic IP address 130, 192
- DynDNS 192
- E**
 - Earpiece mode 36
 - Earpiece volume 109
 - Echo service
 - Gigaset.net 40
 - ECO DECT 24
 - Eco mode 24
 - E-mail
 - account name 154
 - entering access data 154
 - incoming e-mail server 154
 - list 81
 - messages whilst making a
 - connection 82
 - notification 81
 - registration name/password 154
 - settings (Web config.) 154
 - viewing the message header 83
 - viewing the sender's address 83
 - Emergency numbers
 - dialling 32
 - dialling plans for 151
 - when keypad lock is active 8
 - End call key 1, 32
 - Ending, call 32
 - Enter flash 1
 - Enter pause 1
 - Entering access data (e-mail) 154
 - Entering user data 20
 - Error handling
 - messenger 93
 - Error tone 111
 - Ethernet network 192
 - Example

- menu input 176
- multiple line input 176
- Explicit Call Transfer 192
- External call
 - forwarding to ans. mach. 76
- External consultation call
 - fixed line network. 46
 - VoIP 48
- Extra area codes (area codes) 14
- Extra codes 14
- F**
- Factory settings
 - base station 114
- Fast access. 95
 - answer machine 78
 - directory entries 52
- Firewall 192
- Firmware 192
 - automatic update 117
 - checking version. 171
 - starting update (handset) 116
 - starting update (Web conf.) 159
 - updates 11
 - version on delivery 11
- Firmware update
 - automatic. 161
- Fixed line network
 - accepting/rejecting call waiting 46
 - activating/deactivating call waiting . 45
 - call forwarding 45
 - cancelling ring back 46
 - connection name 139
 - enter network mailbox 94
 - external consultation call 46
 - settings for calls 46
 - toggling 46
- Fixed line network connection
 - creating settings. 45
 - line suffix 133
- Flat rate. 192
- Fragmentation of data packets 193
- Free software, licences 179
- Full duplex. 193
- G**
- G.711 μ law 140
- G.711 a law 140
- G.722 140
- G.726 140
- G.729. 141
- Gateway 193
- Gateway provider 193
- Gigaset config. 124, 125
- Gigaset.net. 40
 - (de)activating the connection. . . . 140
 - call forwarding 146
 - calling subscriber 42, 43
 - changing/deleting own name 43
 - directory 40
 - echo service 40
 - entering name. 21, 43
 - Jabber server 153
 - messaging 153
 - searching for subscriber 40
- Gigaset.Net directory
 - specifying/editing own name 43
- Global IP address. 193
- Global System for
 - Mobile Communication. 193
- GNU Lesser General Public License. . 179
- Going online (messenger) 85
- Group call 101
- GSM 193
- Guarantee Certificate 173
- H**
- Handset
 - activating/deactivating 1, 37
 - activating/deactivating advisory
 - tones 111
 - assigning a receive number 144
 - assigning a send number 144
 - changing internal names 100, 156
 - changing internal number 100, 156
 - changing name 100, 156
 - checking service information 171
 - contact with liquid 163
 - de-registering 99
 - display backlight 107
 - display language 106
 - earpiece volume 109
 - handsfree volume 109
 - idle status 38
 - list 37
 - locating. 99
 - loudspeaker volume. 38
 - muting 36
 - operating 37
 - reducing transmission power 24

- registering 14, 98
- reset 113
- restoring to factory settings. 113
- screen picture 107
- setting (individual) 106
- setting up 11
- transferring a call 101
- using room monitor 104
- using several 98
- Handset directory, see Directory
- Handset operating time
 - in room monitor mode 104
- Handsfree
 - activating/deactivating 36
 - key. 1
 - mode. 36
 - talking 36
- Hash key 1, 37
- Headset. 1, 24, 194
- Hearing aids 7
- HTTP proxy 194
- Hub. 194
- I**
- Icon
 - alarm clock. 112
 - answer machine. 71
 - battery. 13
 - new message 74
 - new messenger message 89
 - new SMS 64
 - ringer tone 111
 - ringer tone deactivated. 111
- Idle status
 - back to. 38
 - display 1
- IEEE. 194
- Incoming e-mail server (e-mail) 154
- Incoming message list
 - e-mail 81
 - opening (SMS) 64
- Incorrect input (correction). 39
- Info messages (messenger) 90
- Info services 155
 - configuring 155
- Infrastructure network 194
- Installing, base station 14
- Instant messaging 84, 152, 194
 - preconditions 84
- Institute of Electrical and
 - Electronics Engineers 194
- Interface language
 - handset. 106
- Interface language for
 - Web configurator 125
- Internal call. 101
 - call waiting 102
- Internal consultation call. 38, 102
- Internal listening in 103
 - activating/deactivating signal
 - tone 103
- Internet 194
 - access (Broadband) 189
 - no connection to 22
 - protocol 194
 - service provider. 194
- IP 194
- IP address 194
 - assigning (handset) 120
 - assigning (Web configurator) 130
 - automatically obtaining one. 120, 130
 - checking (handset) 120
 - checking (Web configurator) 162
 - dialling 32
 - displaying on handset 2
 - dynamic 192
 - global 193
 - local 195
 - private 197
 - public 197
 - static. 199
- IP address type 120, 130
- IP configuration
 - handset. 120
 - Web configurator. 130
- IP pool range 195
- J**
- Jabber ID (messenger). 153
- Jabber server (messenger). 153
- Jabber server port (messenger) 153
- K**
- Key 1 (fast access). 1, 78
 - assign 95
- Key click 111
- Keypad
 - change configuration. 108
- Keypad lock 8, 37
- Keys

- assigning directory entry 50, 52
 - call-by-call key 1
 - cancel key 38
 - control key 1, 37
 - display keys 1, 38
 - end call key 1, 32, 39
 - fast access 1, 78
 - handsfree key 1
 - hash key 1, 37
 - keypad lock 37
 - message key 1, 57
 - on/off key 1
 - paging key (base station) 2
 - quick dial 50, 52
 - recall key 1
 - star key 1, 111
 - talk key 1
- L**
- LAN 195
 - Language
 - display 106
 - handset 106
 - Web configurator 125
 - Last number redial 56
 - LGPL 179
 - Licences, free software 179
 - Line suffix
 - dialling with 31
 - display (Web configurator) 133
 - Line type
 - for outgoing calls 144
 - Linking, see SMS
 - Liquid 163
 - List
 - answer machine list 59
 - calls list 58
 - e-mail notifications 81
 - handsets 37
 - last number redial list 56
 - missed calls 58
 - network mailbox 96
 - Listening in to a call 103
 - Local area code 14
 - Local Area Network 195
 - Local communication ports 147
 - Local IP address 195
 - Local network 130
 - Local SIP port 199
 - Locate
 - handset 99
 - Lock (keypad lock) 37
 - Login password
 - messenger 153
 - Lost connection
 - messenger 86, 93
 - Loudspeaker volume 38
- M**
- MAC address 195
 - checking (handset) 121
 - checking (Web configurator) 162
 - Mailbox ID, see SMS
 - Mailboxes, see SMS
 - Main menu 25, 39
 - Mains adapter 7
 - Making calls
 - accepting a call 33
 - cost-effective calls 60
 - external (VoIP, fixed line network) 30
 - internal 101
 - Maximum Receive Unit 195
 - Maximum Transmission Unit 195
 - Mbps 195
 - Media Access Control 195
 - Medical appliances 7
 - Memory 52
 - Menu
 - end tone 111
 - going back one menu level 38, 39
 - menu bar (Web configurator) 127
 - menu guidance 39
 - menu input 176
 - opening 37
 - phone overview 25
 - Web configurator overview 29
 - Message 71
 - deleting 75
 - deleting (messenger) 91
 - marking as "new" 75
 - new message icon 74
 - playing back 74
 - reading the subject (e-mail) 83
 - receiving (messenger) 89
 - receiving (SMS) 64
 - writing/sending (messenger) 91
 - writing/sending (SMS) 62
 - Message (ans. mach.)
 - list 59
 - playback via remote operation 79

- playing 59
 - Message key 1
 - opening lists 57
 - Message list
 - e-mail 81
 - messenger 90
 - SMS 64
 - Messages
 - listening to network mailbox 96
 - Messaging
 - Gigaset.net 153
 - Messenger 84
 - account 153
 - calling buddy 92
 - change own status 86
 - entering access data 152
 - error handling 93
 - errors when sending 93
 - lost connection 86, 93
 - message list 90
 - priority 152
 - resource name 152
 - Messenger message
 - deleting 91
 - reading 91
 - receiving 89
 - writing/sending 91
 - Messenger server 84
 - establishing a connection 85
 - Microphone 1
 - Million bits per second 195
 - Missed calls 58
 - MRU 195
 - MTU 195
 - Multiple line input 176
 - Music on hold 36, 115, 195
 - Muting
 - handset 36
 - microphone 36
- N**
- Name
 - changing name of the
 - handset 100, 156
 - displayed (VoIP) 191
 - fixed line network
 - connection 134, 139
 - of caller from online directory . 34, 155
 - NAT 196
 - symmetric 199
 - updating 138
 - Navigation area (Web config.) 127
 - Network 196
 - area 137
 - Ethernet 192
 - provider (numbers list) 49
 - Network Address Translation 196
 - Network mailbox 94
 - activating/deactivating 94, 151
 - calling 96, 97
 - define for fast access 95
 - entering number 94, 151
 - list 96
 - Network MB, see Network mailbox
 - Network services
 - fixed line and VoIP 44
 - fixed line network 45
 - settings for fixed line network
 - calls 45, 46
 - settings for VoIP calls 47, 48
 - VoIP 47
 - Notification
 - incoming e-mail 81
 - notification via SMS 66
 - Number
 - as destination for room monitor . . 104
 - copying from an SMS 65
 - copying from directory 53
 - copying to directory 53
 - displaying caller's number (CLIP) . . 33
 - entering network mailbox
 - number 94, 151
 - entering with directory 53
 - saving in the directory 50
 - Number assignment 144, 145
 - Number display
 - withholding 44
 - Numbers list
 - network provider 49
- O**
- Offline (messenger) 84, 86
 - On/Off key 1
 - Online (messenger) 84, 86
 - Online directory 53
 - Gigaset.net 40
 - opening 37
 - register for access 155
 - Opening the incoming e-mail list . . . 81
 - Operation (preparing to use the

phone) 11
 Order in directory 50
 Outbound proxy 138, 196
 mode 138
 port 139
 Own area code
 enter 148
 Own dialling code
 area code 14

P

PABX
 operating base station on PABX . . . 122
 pauses 122
 setting dialling mode 122
 setting recall 122
 SMS 69
 Pack contents 11
 Paging 2, 99, 196
 Pauses (PABX) 122
 Personal Identification Number 196
 Personal provider data 136
 Phone
 configuring via PC 124
 functions, overview 25
 menu overview 25
 protecting 114
 setting (Web configurator) 129
 setting base station
 (on handset) 114
 setting up 11
 status (Web configurator) 162
 Phone jack pin configuration 17
 Phone number display
 withholding 44
 PIN 196
 changing 114
 Playback (ans. mach.) 59
 remote operation 79
 Playing back
 announcement (answer machine) . . 73
 message (answer machine) 74
 POP3 server 154
 Port 196
 Port forwarding 197
 Port number 197
 Power consumption of base station . 175
 Pre-dialling 197
 Preferred DNS server

 entering (handset) 121
 entering (Web configurator) 131
 Priority (messenger) 152
 Private IP address 197
 Problems and solutions 163
 Protocol 197
 Proxy 197
 Proxy server 197
 Proxy server address 136
 Public IP address 197

Q

Quality of Service 197
 Questions and answers 163
 Quick dial 49, 50, 52

R

RAM 198
 Random Access Memory 198
 Read Only Memory 198
 Reading message (messenger) 91
 Ready to chat (messenger) 86
 Recall 101
 Recall key 1
 function for VoIP 147
 Receive number
 answer machine 71
 assigning to answer machine 145
 assigning to handset 144
 display on the handset 34
 Recording
 quality (ans.mach.) 78
 time (ans.mach.) 78
 two-way recording 76
 Registering
 handset 14, 98
 with the Web configurator 125
 Registrar 198
 server 137
 server port 137
 Registration name
 e-mail 154
 VoIP account 20, 119, 136
 Registration password
 e-mail 154
 VoIP account 20, 119, 136
 Registration refresh time 137
 Remote access to Web configurator . 131
 Remote management 131
 Remote operation 79

- Resetting
 - base station 114
 - handset 113
- Resource name (messenger) 152
- RFC 2833 (DTMF signalling) 146
- Ringback
 - initiating (fixed line network) 46
 - when busy 198
 - when the call is not answered 198
- Ringer tone
 - activating/deactivating 111
 - changing 110
 - deactivating permanently 111
 - muting 33
 - setting melody 110
 - setting volume 110
- ROM 198
- Room monitor 104
- Router 198
 - connecting base station 17
- Routing 198
- RTP 198
- RTP port 147, 198
- S**
- Safety precautions 7
- Scope of delivery 11
- Screen picture 107
- Search for subscriber on Gigaset.net 40
- Searching
 - in directory 51
- Select entry (menu) 176
- Select online directory 155
- Selecting announcement mode
 - (ans. mach.) 72
- Sender's address (e-mail) 83
- Sensitivity (room monitor) 105
- Server 199
- Server for firmware update 159
- Server port 136
- Service 172
- Set
 - date/time on handset 13
 - default connection 116
 - online directory 155
 - ringer tone melody 110
- Setting
 - base station 114
 - default connection 144
 - flash time (PABX) 122
 - handset 106
 - screen picture 107
 - time zone 161
- Settings for VoIP telephony 133
- Shortcut (digit combination) 25
- Signal strength 1
- Signal tone for internal listening in 103
- Signal tone, see Advisory tones
- Simple Transversal of UDP over NAT 199
- SIP 199
- SIP address 199
- SIP Info (DTMF signalling) 146
- SIP port 147, 199
- SIP provider 199
- SIP proxy server 199
- Slumber mode (alarm clock) 112
- SMS 61
 - activating/deactivating function 69
 - changing mailbox 68
 - deleting 63
 - draft message list 63
 - forwarding 65
 - linked 61
 - mailbox ID 67
 - notification by SMS 66
 - notification number 66
 - notification type 66
 - PIN protection 67
 - reading 63
 - receiving 64
 - registration assistant 62
 - replying to and forwarding 65
 - rules 61
 - saving number 65
 - self help with error messages 70
 - sending to a personal mailbox 68
 - setting up a mailbox 67
 - to a PABX 69
 - troubleshooting 69
 - writing/sending 62
- SMS centre
 - changing number 68
 - setting 68
- Snooze (alarm clock) 112
- Sound, see Ringer tone
- Special characters 178
- Specifications 174
- Standard gateway
 - entering (handset) 121
 - entering (Web configurator) 130

- Star key 1, 111
 - Start connection assistant (menu) . . 118
 - State of presence (messenger) . . . 84, 86
 - setting own 86
 - Static IP address 130, 199
 - Status
 - buddy 84
 - changing own (messenger) 86
 - VoIP connection 133
 - Status codes
 - activating display (handset) 121
 - activating display (Web config.) . . . 159
 - Status codes (VoIP), table 168
 - Structure of IP address 194
 - STUN 199
 - STUN port 138
 - STUN refresh time 138
 - STUN server 138
 - Submenu 39
 - Subnet 199
 - Subnet mask 199
 - defining (handset) 120
 - defining (Web configurator) 130
 - Suffix 133
 - dialling with 31
 - Summer time
 - changing automatically to 161
 - Suppressing
 - silence 143
 - speech pauses (VoIP) 143
 - Symmetric NAT 199
 - Synchronisation with time server . . . 161
 - System settings 114
- T**
- Talk key 1
 - TCP 200
 - Telephone book file
 - content (vCard format) 158
 - Telephone connection
 - configuring (Web config.) 132
 - Text information
 - in idle display mode 155
 - Text message, see SMS
 - Time
 - setting manually 13
 - transferring from time server 161
 - Time server 161
 - TLS 200
 - Toggleing 200
 - disconnecting call 46, 48
 - fixed line network 46
 - VoIP 48
 - Touch tone dialling 123
 - Transfer rate 200
 - Transferring PC address book
 - to directory 157
 - Transmission Control Protocol 200
 - Transmission power
 - reducing for the base station 24
 - reducing for the handset 24
 - Transport Layer Security 200
 - Transport protocol 200
 - Troubleshooting 163
 - e-mail 82
 - Internet connection 22
 - SMS 69
- U**
- UDP 200
 - Uniform Resource Identifier 200
 - Universal Resource Locator 200
 - Unknown 35
 - Unknown caller 35
 - URI 200
 - URL 200
 - Use random ports 147
 - User Datagram Protocol 200
 - User identification 200
 - User name
 - (VoIP-Account) 20, 119, 136
- V**
- vCard format 159
 - vcf file 157
 - Version check, automatic 161
 - VIP (directory entry) 51
 - Voice over Internet Protocol 10, 201
 - Voice quality 140
 - Voice quality and infrastructure 143
 - VoIP 201
 - accepting/rejecting call waiting 48
 - activate/deactivate network
 - mailbox 94
 - activating/deactivating call waiting . . 47
 - advantages 10
 - assigning IP address 120
 - call forwarding 47
 - completing settings 22
 - conference call 48

- configuring account 133
 - configuring account (first) 20
 - connection name 134
 - enter network mailbox 94
 - external consultation call 48
 - loading provider data . . . 20, 118, 135
 - making call settings 47
 - network services. 47
 - phone number 20, 134
 - preconditions 10
 - settings (on handset) 118
 - show called party number 35
 - start connection assistant 18, 118
 - status codes (table) 168
 - toggleing 48
 - VoIP connection
 - activating/deactivating 133, 139
 - automatic configuration 134
 - configuring (handset) 118
 - configuring (Web configurator) . . . 133
 - line suffix 133
 - name (Web configurator) 134
 - name/provider (Web config.) 132
 - VoIP provider 201
 - downloading data. 20, 135
 - selecting (Web configurator) 135
 - updating data automatically 161
 - VoIP status messages
 - activating display (handset). 121
 - activating display (Web config.) . . 159
 - status codes table. 168
 - VoIP telephony
 - settings (Web config.) 133
 - VoIP user data
 - entering 20
 - entering (handset) 119
 - entering (Web configurator) 136
 - Volume
 - earpiece 109
 - earpiece volume. 109
 - handset handsfree volume 109
 - handset language. 38
 - loudspeaker 109
 - ringer tone 110
- W**
- Wall mounting
 - base station 215
 - charging cradle. 214
 - WAN 201
 - Warning tone, see Advisory tones
 - Web configurator 124
 - activating VoIP connection 133
 - alternative DNS server 131
 - assign receive number to
 - ans. mach. 145
 - assigning receive number. . . 144, 145
 - assigning send number 144
 - checking EEPROM version 162
 - checking firmware version 162
 - checking IP address 162
 - checking MAC address 162
 - connecting with PC 124
 - creating e-mail settings 154
 - deactivating VoIP connection 133
 - defining IP address. 130
 - defining standard gateway. 130
 - de-registering 126
 - directory transfer 157
 - DTMF-reminder for VoIP. 146
 - firmware update 159
 - interface language. 125
 - IP configuration 130
 - local network. 130
 - menu 29
 - messenger access data. 152
 - name of a VoIP connection. 134
 - name/provider of a connection . . . 132
 - number assignment. 144, 145
 - opening Web page. 128
 - phone status 162
 - preferred DNS server 131
 - remote access 131
 - selecting IP address type 130
 - setting phone 129
 - specifying dialling plans 149
 - status of a VoIP connection 133
 - structure of the Web pages. 126
 - subnet mask 130
 - Web interface, see Web configurator
 - Web page (Web configurator)
 - opening 128
 - structure 126
 - Web server, see Web configurator
 - Wide Area Network 201
 - Withhold
 - number display 44
 - Working area (Web configurator) . . . 127
 - Writing (SMS) 62
 - Writing, editing text 177

Mounting the charging cradle to the wall, connecting the charging cradle

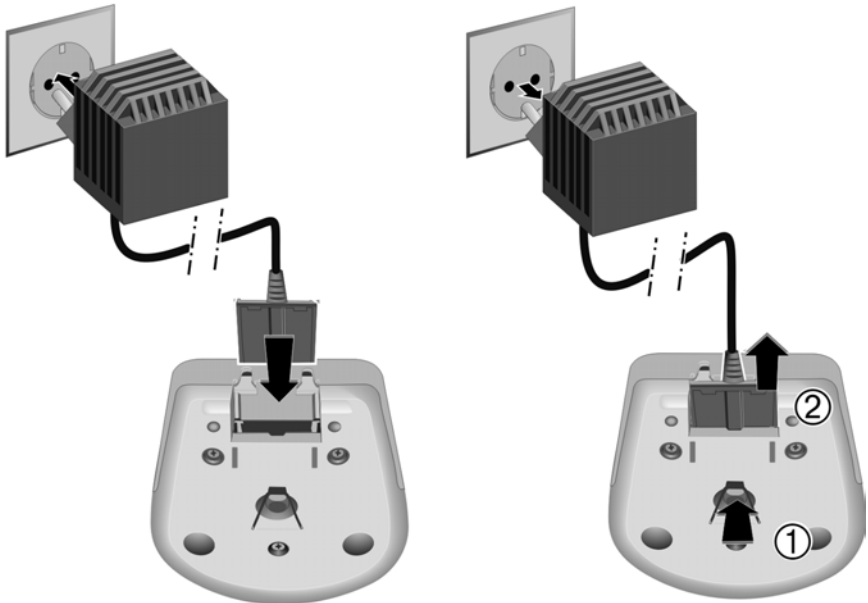
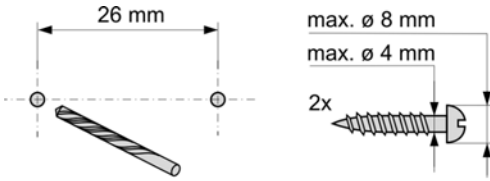

Mounting the base station to the wall

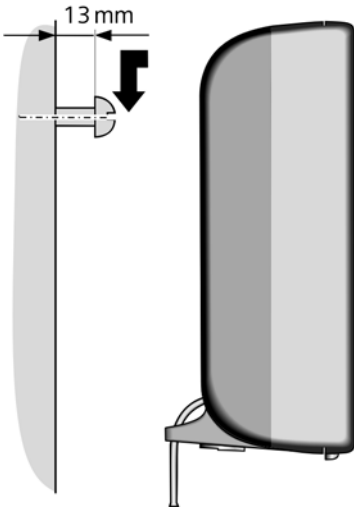
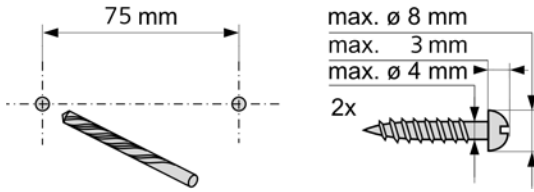

Issued by
Siemens Home and Office Communication Devices GmbH & Co. KG
Schlavenhorst 66
D-46395 Bocholt

© Siemens Home and Office Communication Devices GmbH & Co. KG 2008
All rights reserved. Subject to availability.
Right of modification reserved.

www.siemens.com/gigaset