

Gigaset

C530 IP

Congratulations

By purchasing a Gigaset, you have chosen a brand that is fully committed to sustainability.

This product's packaging is eco-friendly!

To learn more, visit www.gigaset.com.



GIGASET. INSPIRING CONVERSATION.
MADE IN GERMANY

Gigaset C530 IP – Your perfect companion

... with impressive internal qualities. The large TFT display, user-friendly keypad and clearly laid out menu are very simple to use. Your Gigaset can do a lot more than just make calls:

Ethernet port

Connect your Gigaset to the Internet and your PC via Ethernet. Use public and private directories online (→ page 86). Update the phonebook on your Gigaset and your directory on the PC simultaneously.

Directory for 200 vCards – appointments

Save phone numbers and other data to the local directory (→ page 83). Enter anniversaries in the phonebook and set reminders (→ page 98).

Use your Gigaset as a PABX

Register up to six handsets. Assign each device its own phone number.

It's easy to configure your Gigaset thanks to the wizards

The wizards help you to configure the VoIP connections for your phone and to assign the receive and send connections to the registered handsets.

Go online with your Gigaset

Use your phone's Info Centre and have information specifically provided for the phone from the Internet shown on the display (→ page 70).

Other practical information

Transfer the phonebook from an existing Gigaset handset (→ page 85), use the programmable digit and display keys (→ page 49) for quick dial or quick access to important functions, read your e-mail messages on your phone (without a PC).

Environment

Gigaset Green Home – Be environmentally aware when using your phone. You can find details on our ECO DECT products at www.gigaset.com/service.

Further information on your phone can be found online at www.gigaset.com/gigasetC530ip.

After purchasing your Gigaset phone, please register it at www.gigaset.com/service – this will enable us to help you more quickly if you have any questions or need to make a claim on the guarantee!

Have fun using your new phone!

Overview of handset



- 1 **Display in idle status**
- 2 **Status bar**
Icons display current settings and operating status of the phone
- 3 **Display keys** (→ page 28)
- 4 **Message Key** (→ page 29)
Access to the calls and message lists;
Flashing: new message or new call
- 5 **End call key, On/off key**
End call; cancel function; go back one menu level (press **briefly**); go back to idle status (press and **hold**); switch handset on/off (press and **hold** in idle status)
- 6 **Hash key**
Keypad lock on/off (press and **hold** in idle status);
Toggle between upper/lower case and digits;
Insert a dialling pause (press and **hold**)
- 7 **Microphone** (→ page 35)
- 8 **Recall key**
Consultation call (flash) (press and **hold**)
- 9 **Star key**
Ringtone on/off (press and **hold** in idle status);
Open special characters table (when inputting text)
- 10 **Connection socket for headset** (→ page 24)
- 11 **Key 1**
Dial network mailbox (press and **hold**)
- 12 **Talk key / Handsfree key**
Dial number displayed;
Accept call; switch from earpiece to handsfree mode;
Open the redial list (press **briefly**)
- 13 **Control key / Menu key** (→ page 27)

Overview of base station

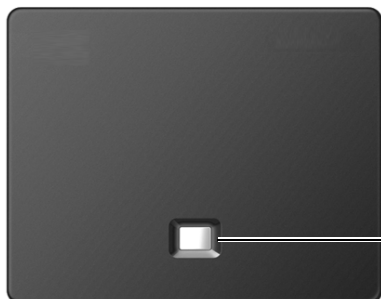

Paging key

Lit up: LAN connection active (phone is connected to router)

Flashing: Data transfer to LAN connection

Start paging, display IP address on handset: ▶ Press **briefly**

Set base to registration mode:
▶ Press and **hold**

Contents

Gigaset C530 IP – Your perfect companion	1
Overview of handset	2
Overview of base station	3
Safety precautions	5
Getting started	7
Understanding the operating steps in the user guide	26
Getting to know your phone	27
Making calls	31
Using provider-specific functions (network services)	38
Making cost-effective calls	43
Adjusting the telephone settings	44
Configuring the system settings	51
Operating a repeater	58
SMS (text messages)	59
E-mail notifications	67
Info Centre – continuous Internet access from your phone	70
Network mailbox	75
Multiple handsets	78
Directories	83
Call lists	94
ECO DECT	96
Alarm clock	97
Calendar	97
Baby monitor	99
Operating the telephone on a PABX	101
Display icons	103
Menu overview	105
Configuring the phone via the Web configurator	108
Customer Service & Assistance	130
Environment	140
Appendix	140
Glossary	144
Accessories	156
Mounting the base on the wall	160
Mounting the charging cradle on the wall	161
Index	162

Safety precautions

Warning

Read the safety precautions and the user guide before use.

Explain their content and the potential hazards associated with using the device to your children.



Use only the power adapter indicated on the device.

Use only the cables supplied for fixed line and LAN connection and connect these to the intended ports only.



Use only **rechargeable batteries** that correspond to the **specification** (see "Specifications"). Never use a conventional (non-rechargeable) battery or other battery types as this could result in significant health risks and personal injury. Rechargeable batteries, which are noticeably damaged, must be replaced.



Using your telephone may affect nearby medical equipment. Be aware of the technical conditions in your

particular environment, e.g. doctor's surgery.

If you use a medical device (e.g. a pacemaker), please contact the device manufacturer. They will be able to advise you regarding the susceptibility of the device to external sources of high frequency energy (for the specifications of your Gigaset product see "Specifications").



Do not hold the rear of the handset to your ear when it is ringing or when speaker mode is activated. Otherwise you risk serious and permanent damage to your hearing.

Your Gigaset is compatible with the majority of digital hearing aids on the market. However, perfect function with all hearing aids cannot be guaranteed.

The phone may cause interference in analogue hearing aids (humming or whistling) or cause them to overload. If you require assistance, please contact the hearing aid supplier.



The devices are not splashproof. For this reason do not install them in a damp environment such as bathrooms or shower rooms.



Do not use the devices in environments with a potential explosion hazard (e.g. paint shops).



If you give your Gigaset to a third party, make sure you also give them the user guide.



Remove faulty devices from use or have them repaired by our Service team, as these could interfere with other wireless services.



Do not use the device if the display is cracked or broken. Broken glass or plastic can cause injury to hands and face. Send the device to our Service department to be repaired.



To prevent loss of hearing, avoid listening at high volume over long periods of time.

Safety precautions

Please

- ◆ The device cannot be used in the event of a power failure. It is also **not** possible to transmit **emergency calls**.
- ◆ Emergency numbers **cannot** be dialled if the **keypad/display lock** is activated!

Getting started

Checking the contents of the package



- 1 Gigaset C530 IP**base**
- 2 Power adapter to connect the base to the mains power supply
- 3 Phone cable (flat) to connect the base to the analogue fixed line network
- 4 Ethernet (LAN) cable to connect the base to the router (LAN/Internet)
- 5 Gigaset C530H **handset**
- 6 Two batteries for the handset (not charged)
- 7 Battery cover for the handset
- 8 Belt clip for the handset
- 9 **Charging cradle** for the handset

Getting started

- 10** Power adapter to connect the charging cradle to the mains power supply
- 11** Brief introduction with installation wizard for your telephone, license texts, warranty agreement and links to important websites.
In the event of any firmware updates for your base, the user guide is also updated if necessary and available to download online from www.gigaset.com.

Firmware updates

This user guide describes the functions of your phone from firmware version 080 onwards.

Whenever there are new or improved functions for your Gigaset, firmware updates are made available for you to download to your base (→ page 55). If this results in operational changes when using your phone, a new version of this user guide or the necessary amendments will be published on the Internet at

www.gigaset.com.

Select the product to open the relevant product page for your base, where you will find a link to the user guides.

To find out what version of firmware is currently loaded, → page 138.

Installing the base station and charging cradle

The base and charging cradle are designed for use in closed, dry rooms within a temperature range of +5°C to +45°C.

- ▶ Set up the base at a central point in the building or house, or mount the base on the wall (→ page 161).

The phone's feet do not usually leave any marks on surfaces. However, due to the multitude of different varnishes and polishes used on today's furnishings, marks on the surfaces cannot be completely ruled out.

Caution

- ◆ Never expose the telephone to heat sources, direct sunlight or other electrical appliances.
- ◆ Protect your Gigaset from moisture, dust, corrosive liquids and fumes.
- ◆ Pay attention to the range of the base. This is up to 50 m inside buildings and up to 300 m in unobstructed outdoor areas. The range is reduced when **Maximum Range** is deactivated (→ page 96).

Connecting the telephone (overview)

The following diagram is an overview of all connections for your telephone. The individual connections are described in detail below. In order for you to make calls on your phone via the fixed line network and VoIP, you need to connect the base to the fixed line network and Internet.



Follow the steps in the order given below:

- 1 Prepare the handset: Insert and charge batteries (→ page 10)
 - 2 Connect the charging cradle to the mains power supply (→ page 10)
 - 3 Connect the phone cable and power cable to the base (→ page 12)
 - 4 Connect the base to the telephone network and the mains power supply (→ page 12)
 - 5 Connect the base to the router for accessing the Internet and for configuring the base using the Web configurator (connection via router and modem or via router with integrated modem)
 - 6 PC in LAN (optional) - for further configuration of the Gigaset C530 IP base
- You can then connect a wire-bound headset to the handset (→ page 24).

Connecting the charging cradle

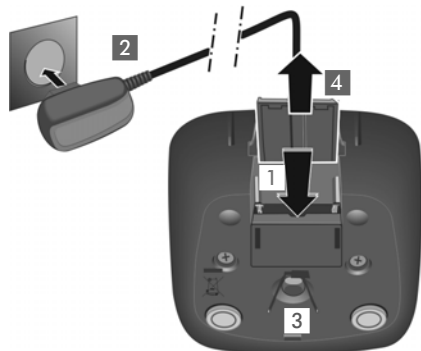

- ▶ Connect the flat plug from the power adapter **1**.
- ▶ Plug the power adapter into the power socket **2**.

To remove the plug from the charging cradle again:

- ▶ Disconnect the power adapter from the mains power supply.
- ▶ Press the release button **3** and disconnect the plug **4**.

Setting up the handset for use

The display is protected by a plastic film. ▶ **Please remove the protective film!**

Inserting the batteries and closing the battery cover

Caution

Use only rechargeable batteries recommended by Gigaset Communications GmbH (→ page 141), as this could otherwise result in significant health risks and personal injury. For example, the outer casing of the batteries could be destroyed or the batteries could explode. The phone could also malfunction or be damaged as a result of using batteries that are not of the recommended type.



- ▶ Insert the batteries with the polarity in the right direction (for correct +/- direction, see diagram).

- ▶ Insert the battery cover from the top **1**.
- ▶ Press the cover until it clicks into place **2**.

To open the battery cover:

- ▶ Grip the notch on the cover **3** and slide it downwards **4**.

Attaching the belt clip

The handset has notches on each side to attach the belt clip.

- ◆ **To attach** — press the belt clip onto the back of the handset so that the tabs on the belt clip click into place in the notches.
- ◆ **To remove** — press the centre of the belt clip firmly with your right thumb, push the fingernail of your left thumb up between the clip and the casing and pull the clip in an upward direction.

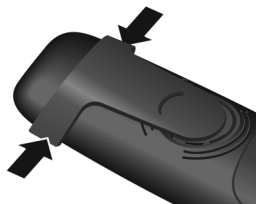

Charging the batteries

The batteries are supplied partially charged. Please charge completely before use. The batteries are fully charged when the power icon ⚡ disappears from the display.



- ▶ Charge the handset in the charging cradle for **6 hours**.

The charge status is shown on the idle display:



Notes

- ◆ The handset may only be placed in the designated base/charging cradle.
- ◆ The battery may heat up during charging. This is not dangerous.
- ◆ After a time, the charge capacity of the battery will decrease for technical reasons.
- ◆ Handsets contained in the package have already been registered to the base. If, however, a handset has not been registered ("**Please register handset**" or "**Place handset in base**" is displayed), please register it manually (→ page 78).

Connecting the base station to the telephone network and the mains power supply

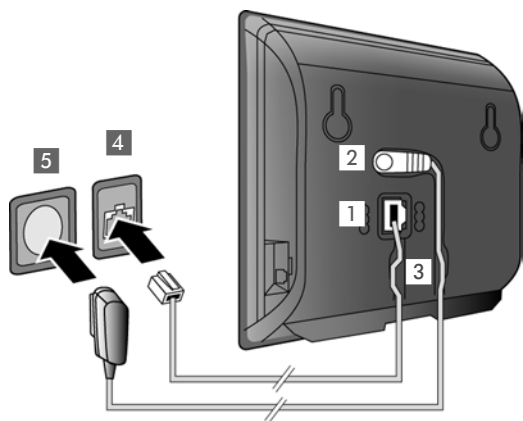

- ▶ Insert the phone cable into the lower connection socket at the rear of the base **1**.
- ▶ Insert the power cable of the power adapter into the upper connection socket **2** at the rear of the base.
- ▶ Insert both cables into the appropriate cable channels **3**.
- ▶ Insert the phone cable into the fixed line network connection **4**.
- ▶ Connect the power adapter into the power socket **5**.

Caution

- ◆ Use only the **supplied** network cable and phone cable. Pin connections on telephone cables can vary (pin connections → page 142).
- ◆ The power cable must **always be connected** in order to function, as the phone will not operate without a power supply.

You can now use your phone to make calls via the fixed line network and can be reached on your fixed line network number.

Connecting the base to a router (Internet)

Data protection notice

When the device is connected to the router, it automatically contacts the Gigaset support server to make it easier for you to configure the devices and to enable communication with the Internet services.

For this purpose, every device sends the following device-specific information once a day:

- ◆ Serial number/item number
- ◆ MAC address
- ◆ Private IP address for the Gigaset in the LAN/its port numbers
- ◆ Device name
- ◆ Software version

On the support server, this information is linked to the existing device-specific information:

- ◆ Gigaset.net phone number
- ◆ System-related/device-specific passwords

Further information about the Gigaset.net service data saved can be found at:

www.gigaset.net/privacy-policy

When you connect the base to a router, your telephone can establish an Internet connection. An Internet connection is required for the following functions:

- ◆ Internet telephony VoIP (Voice over Internet Protocol)
- ◆ Notification as soon as new software is available for your phone on the Internet
- ◆ Configuring date and time with a time server on the Internet
- ◆ Info services and online directories.

For Internet access, you need a router connected to the Internet via a modem (this may be integrated in the router).

You can also connect a PC to the router if you want to set your phone via its Web configurator.

Note

For telephony via the Internet, you need a broadband Internet connection (e.g. DSL) with flat rate (recommended) or volume rate and a router that connects your phone to the Internet. You can find a list of recommended routers on the Internet at:

www.gigaset.com/service

From here, go to the FAQ page and select your Gigaset IP telephone. Search for "Router", for example.

Getting started

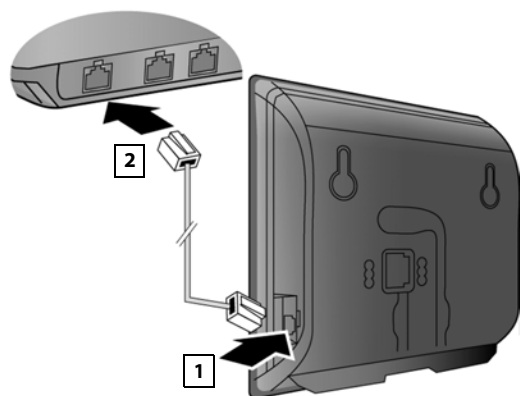

- ▶ Insert a plug from the Ethernet cable supplied (Cat 5 with 2 RJ45 modular jacks) into the LAN connection socket at the side of the base **1**.
- ▶ Then insert the second plug from the Ethernet cable into a LAN socket on the router **2**.



As soon as the cable between the telephone and the router is plugged in and the router is switched on, the key on the front of the base lights up (paging key).

You are now able to establish VoIP connections within Gigaset.net (→ page 36).

Note

- ▶ If you want to change the display language → page 44

Setting up the phone – installation wizard

Before you can use the Internet (VoIP) to phone other numbers on the Internet, the fixed line network or the mobile network, you need the services of a VoIP provider who supports the VoIP SIP standard.

- ▶ Register with at least one VoIP provider and set up at least one VoIP account.

You will receive from your provider:

- ◆ **either** access data (username, authentication name, password etc.)
- ◆ **or** an auto configuration code (activation code)

The installation wizard on your Gigaset phone supports you in setting up your VoIP account.

Two individual wizards are combined to form the installation wizard:

- 1 VoIP wizard for setting up a VoIP account
- 2 Connection wizard for assigning send and receive connections (→ page 20)

Note

You can configure up to 6 VoIP connections. When you get started with the phone, you can initially only set up one VoIP connection. You can set up additional VoIP connections later with the VoIP wizard (→ page 53) or with the Web configurator.

Starting the installation wizard

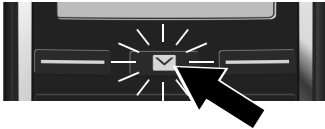

As soon as the handset battery has sufficient charge, the message key  on your handset will flash.

- ▶ Press the Message Key .

If "New firmware available" is shown on the display, there is a firmware update available for your telephone. Press the right display key **Yes**. The new firmware will be downloaded. This takes approx. 6 minutes. The Message Key  then flashes again.

- ▶ **To start configuration:** Press the Message Key .

VoIP wizard – Configuring VoIP settings



- ▶ Press the key below the display screen **Yes** (= right display key) to launch the VoIP wizard.



- ▶ Press down on the control key  to scroll through.
- ▶ Press the display key **OK** to continue.

Getting started

If the connection wizard does not launch as normal or if you cancel the connection wizard, you can launch it via the following menu on the handset:

▶  Control key ▶  Telephony ▶ VoIP Wizard



A list of all possible IP connections will be shown in the display (IP 1 to IP 6). VoIP connections that are already configured are marked with .

- ▶ Select a connection with the control key  if necessary.

- ▶ Press the display key OK to continue.



- ◆ Your VoIP provider has supplied you with an **authentication name/password** and, where applicable, a username:
 - ▶ Press the display key **No**.
 - ▶ For further information, please see: "Downloading VoIP provider data" → page 18.

- ◆ You have received an **auto-configuration code** (activation code) from your VoIP provider:
 - ▶ Press the display key **Yes**.
 - ▶ For further information, please see: "Entering the auto configuration code" → page 17.

No Internet connection:

If an Internet connection cannot be established, one of the following messages is displayed:

- ◆ **IP address not available:** No connection to the router.

Check the plug connection between the router and the base and check the settings on the router.

Your phone is preconfigured for dynamic assignment of the IP address. In order for your router to "recognise" the phone, dynamic IP address assignment must also be activated on the router, i.e. the router's DHCP server must be activated.

If the DHCP server cannot or should not be activated, you must assign a fixed IP address to the phone (→ page 52).

- ◆ **Internet connection not available:** No connection to the Internet.

The IP server may be temporarily unavailable. In this case, try to make a connection again later.

Otherwise: Check the plug connection between the router and the modem or DSL connection and check the settings on the router.

- ▶ If you press **OK**, the VoIP wizard will close.

You will then need to call up the wizard later via the menu to configure the IP connection.

Entering the auto configuration code**Auto configuration:**

The configuration process for VoIP connections is automated for some VoIP providers. The provider creates a configuration file with all required VoIP access data. This file is placed on a configuration server on the Internet for downloading to your phone.

Your provider supplies you with a configuration code. The installation wizard (→ page 15) prompts you to enter the code. All the required VoIP data is then downloaded automatically onto your phone.

The configuration file is only transferred via a secure connection (TLS authentication). If the TLS authentication fails, the message key  flashes. If you press the message key, the message **Certificate error - Please check your certificates in the Web configurator.** is displayed. Press the right display key to confirm the message.

Log in to the Web configurator (→ page 110).

The web page **Security** (→ page 116) tells you why the secure connection could not be established and what you can do.

If the configuration file fails to download (e.g. because the configuration server is not available), the phone keeps trying to establish a connection until the file is downloaded successfully to the phone.

Getting started



- ▶ Using the keypad, enter the auto configuration code you received from the provider (max. 32 characters).

- ▶ Press the display key **OK**.

All data required for VoIP telephony is downloaded directly from the Internet to your telephone. When all the data has been successfully downloaded to your phone, **Your IP account is registered at your provider.** appears on the display.

- ▶ For further information, please see: "Connection wizard" page 20.

Downloading VoIP provider data

The connection wizard establishes a connection with the Gigaset configuration server on the Internet. Various profiles with general access data for different VoIP providers can be downloaded here.

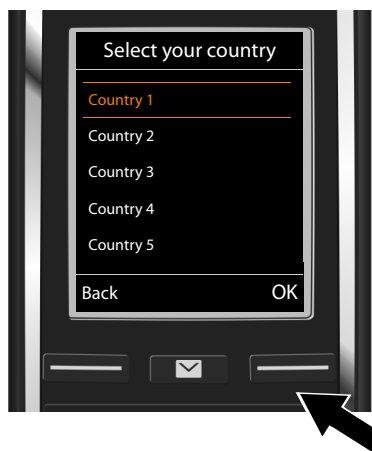

A list of countries is loaded.

- ▶ With the control key , select the country in which you want to use the telephone.

- ▶ Press the display key **OK** to confirm the selection.

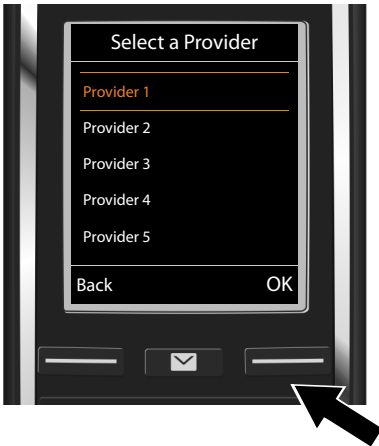

A list of the VoIP providers for which a profile with the general access data is available on the configuration server is displayed.

- ▶ Select your VoIP provider with the control key (↩).

- ▶ Press the display key **OK** to confirm the selection.

The general access data for your VoIP provider is downloaded and saved on your phone.

You have not been able to download your provider's data

If your VoIP provider does not appear in the list, i.e. its general data is not provided for download, cancel the VoIP wizard:

- ▶ Press and **hold** the End call key (⏏). The handset returns to idle status.

You must then make the required VoIP provider and IP account settings using the Web configurator (→ page 117).

You can change the assignment of the VoIP connection as send/receive connection at a later time via the telephone menu or the Web configurator.

Entering user data for your VoIP account





You will now be prompted to enter your personal access data for your VoIP account. The following are provider-dependent:

- **User ID**,
 - **Password**
 - **User name**
- ▶ Enter registration details that you have received from your VoIP provider.
 - ▶ Confirm each entry with the display key **OK**.

If the **User name** is identical to the **User ID**, simply press the display key **OK**.

Please note ...

... when entering access data, it is case sensitive.

- ▶ **To switch between upper/lower case and digit input:** ▶ Press the  key (multiple times if required). You can see briefly in the display whether upper case, lower case or digit input is selected.
- ▶ **To delete incorrectly entered characters:** ▶ Press the display key . The character to the left of the cursor is deleted.
- ▶ **To navigate within an input field:** ▶ Press the control key .

If you have entered all the VoIP data fully and correctly, the message "**Your IP account is registered at your provider.**" will be shown in the display shortly afterwards. The VoIP wizard will then close.

The connection wizard starts.

Connection wizard

Use the connection wizard to assign previously configured connections (fixed line network connection, Gigaset.net connection → page 36 and the VoIP connections → page 15) to the internal participants as receive or, if applicable, as send connections. Internal participants are the registered handsets.



- ◆ **Receive connections** are the phone numbers (connections) on which you can be called. Incoming calls are only forwarded to the internal participants (end devices) for which the relevant connection is assigned as a receive connection.
- ◆ **Send connections** are the numbers that are sent to the called participant. The network provider calculates charges based on the send connections. You can assign each internal participant a number or the associated connection as a send connection.
- ◆ Each connection (number) of your phone can be both a send as well as a receive connection. You can assign each connection to several internal participants as a send and/or receive connection.

Default assignment

All configured connections are assigned as receive connections at registration/start-up.

The fixed line network connection is assigned to the handsets as a send connection.

- a.
- 
- ▶ Press the display key **Yes** if you want to change the setting for send and receive connections of the **handset** with the internal name **INT1**.
 - ▶ Press the display key **No** if you do not want to change the setting for this handset.

- b.
- 
- The list of currently assigned receive connections will be displayed. Scroll through the list with the control key  if required.
- ▶ Press the display key **Change** if you want to change the receive connection setting. Continue from → c.
 - ▶ Press the display key **OK** if you do not want to change the setting. Continue from → d.

Getting started



If no calls to the VoIP connection IP1 are to be signalled on the handset:

- ▶ Press **right** on the control key  to set to **No**.



- ▶ Press **down** on the control key  to switch to the next connection. Set **Yes** or **No** as described above.
- ▶ Repeat the steps for each connection.
- ▶ Press the display key **Save** once you have finished configuring the settings for the handset.

The display will show the up-to-date list of receive connections for verification once again.

- ▶ Press the display key **OK** to confirm the assignment.

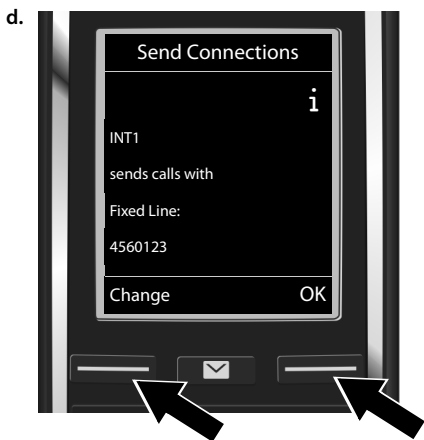

The send connection that is currently set for the handset is displayed:
Fixed Line.

- ▶ Press the display key **OK** if you do not want to change the setting. The following step is skipped.
- ▶ Press the display key **Change** if you want to change the setting.

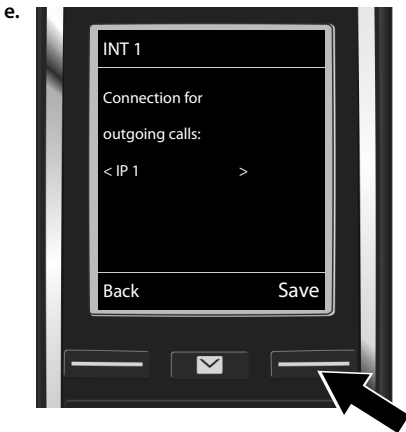

If the handset is to make calls via a different connection/phone number:

- ▶ Press **right** on the control key  as often as required until the desired connection is displayed (in example IP1).



- ▶ Press the display key **Save** to save the settings.

Instead of a connection, you can also select **Sel. at each call**. Each time you make a call, you can then select the connection you wish to use on this handset.

If other handsets are already registered to the base, you are requested to assign send and receive connections for the handsets. The following is shown in the display:

Assign connections to handset ?

- ▶ Perform the steps a. to e. for each registered handset.

After successfully configuring the settings, you will briefly see the display **Connection assignment complete**.

Completing the installation

The handset then returns to idle status (an example of the display in idle status):









Displays

- ◆ Reception between the base and handset:

- good to poor:    
- no reception:  (red)

Colour **green**: **Maximum Range** deactivated.

- ◆ Battery charge status:

-  White: charged over 66%
-  White: charged between 34% and 66%
-  White: charged between 11% and 33%
-  Red: charged below 11%
-  Flashes red: Battery almost empty (less than ten minutes of talktime)
-     White: Battery is charging

- ◆ INT 1: Internal name of the handset

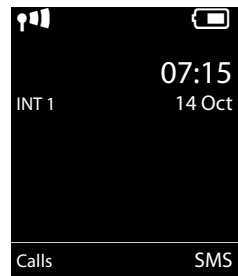

Note

To protect your phone and its system settings from unauthorised access, you can define a 4-digit number code (system PIN) known only to yourself. This code must also be entered before you can register/de-register handsets, or alter the VoIP or LAN settings of your phone.

The default system PIN is 0000 (4 x zero).

For instructions on changing the PIN, → page 51.

Date and time

There are two methods of setting the date and time:

- ◆ By default, your phone is configured so that the date and time are transferred from a time server on the Internet, provided it is connected to the Internet.
You can activate/deactivate the synchronisation with a time server via the Web configurator (→ page 125).
- ◆ You can also set the date and time manually via the menu on one of the registered handsets (→ page 51).

To ensure you have the correct time for incoming calls and to use the alarm clock and calendar, the date and time must be set.

Connecting the headset to the handset (optional)



You can connect a headset with a 2.5 mm jack connector. For information on recommended headsets, see the relevant product page at www.gigaset.com.

Proceeding









After successfully setting up the phone, you can make calls straight away, customise your Gigaset according to your requirements (→ page 44) or firstly familiarise yourself with the operation (→ page 27).

Making external calls and accepting calls	→ page 31
Setting the ringtone melody and volume	→ page 46
Storing your own area code in the telephone	→ page 52
Configuring ECO DECT settings	→ page 96
Preparing the telephone for SMS reception	→ page 59
Operating the telephone on a PABX	→ page 101
Registering available Gigaset handsets to the base and transferring their phonebook entries to the new handset	→ page 78 → page 85
Using online directories	→ page 86
Entering additional VoIP accounts	→ page 53
Configuring the phone via the Web configurator	→ page 108

If you have any questions about using your phone, please read the tips on troubleshooting (→ page 131) or contact our Customer Care team (→ page 130).

Understanding the operating steps in the user guide

The keys on your Gigaset handset are set out in these operating instructions as follows:









 /  / 	Talk key / Menu key / End call key
 to 	Number / Letter keys
 / 	Star key / Hash key
 / 	Messages key / R key

Example: Activating/deactivating Auto Answer

Illustration in the user guide:

 ▶  ▶ **OK** ▶  **Telephony** ▶ **OK** ▶ **Auto Answer** ▶ **Change** (☑ = activated)

Follow this procedure:

- ▶ : With the handset in idle status, press **right** on the control key to open the main menu.
- ▶ : Navigate to the  icon using the control key .
- ▶ **OK**: Press the display key **OK** or the centre of the control key  to open the submenu **Settings**.
- ▶  **Telephony**: Scroll to the entry **Telephony** with the control key .
- ▶ **OK**: Press the display key **OK** or the centre of the control key  to open the submenu **Telephony**.
- ▶ **Auto Answer**: The activate/deactivate auto answer function is selected.
- ▶ **Change** (☑ = activated): Press the display key **Change** or the centre of the control key  to alternate between activating or deactivating (☑ = activated, ☐ = deactivated).

Getting to know your phone

Activating/deactivating the handset

- ▶ Press and **hold** the End call key  to switch the handset on or off.

Locking/unlocking the keypad



The keypad lock prevents any accidental use of the phone. If you press a key when the keypad is locked, a message is displayed.

- ▶ Press and hold the  key to lock or unlock the keypad.

If the keypad lock is activated, you will see a message when you press a key.

The keypad lock deactivates automatically when you receive a call. It is reactivated when the call is finished.







Control key

The side of the control key (up, down, right, left, centre) that you need to press in each operating situation is marked in black below, e.g.  for "press right on the control key" or  for "press the centre of the control key".



The control key allows you to navigate within menus and entry fields. In idle status or during an external call, it has the following functions:



When the handset is in idle status

-  Press **briefly**: Open the handset phonebook.
-  Press and **hold**: Open the list of available online directories.
-  or  Open the main menu.
-  Open the list of handsets.
-  Bring up the menu for setting the handset's call volume (→ page 46).

During an external call

-  Open the phonebook.
-  Initiate an internal consultation call.
-  Adjust the loudspeaker volume for earpiece and handsfree mode.

Functions when pressing the centre of the control key

The key has different functions, depending on the operating situation.

- ◆ **In idle status**, it opens the main menu.
- ◆ **In submenus, selection and entry fields**, the key takes on the function of the display keys **OK**, **Yes**, **Save**, **Select** or **Change**.

Note

These instructions demonstrate opening the main menu by pressing right on the control key  and confirming the functions by pressing the appropriate display key. However, if you prefer, you can use the control key as described above.

Display keys

The display keys have a function preset by default in idle status, but the keys can be re-assigned (→ page 49).

The functions of the display keys change depending on the operating situation. Example:

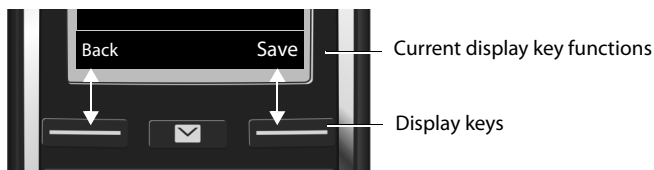

Some of the important display keys are:

Options	Open a menu for further functions.
OK	Confirm selection.
< C	Delete key: Delete character/word from right to left.
Back	Skip back one menu level or cancel operation.
Save	Save entry.
→→	Open redial list.

Overview of icons on the display keys (→ page 104).

Menu guidance

The functions of your telephone are displayed on a menu that consists of several levels. Menu overview → page 105.

Main menu (first menu level)

► When the handset is in idle status, press **right** on the control key  to open the main menu.

The main menu functions are shown in the display as icons. The icon for the selected function is highlighted in orange and the name of the associated function appears in the display header.

Accessing a function, i.e. opening the corresponding submenu (next menu level):

► Use the control key  to navigate to the required function and press the display key **OK**.

Returning to idle status: **Briefly** press the display key **Back** or End call key .

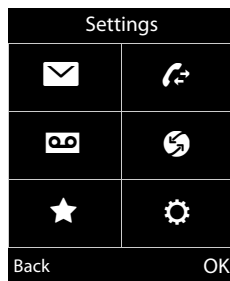

Submenus

The functions in the submenus are displayed as lists (see the example on the right).

To access a function:

- ▶ Scroll to the function using the control key . ▶ Press **OK**.

To return to the previous menu level: **Briefly** press the display key **Back** or the End call key .

Returning to idle status

From any menu:

- ▶ Press and **hold** the End call key .





Or:

- ▶ The display **automatically** returns to idle status after 2 minutes.

Any settings you have not confirmed by pressing **OK**, **Yes**, **Save** or **Change** will be discarded.

Message lists

Any messages you receive are saved in the message lists. The message key  flashes (if activated, → page 125). The flashing stops when you press the key. In **idle status**, the display shows an icon for the new message:

-  on the network mailbox (→ page 75)
-  in the missed calls list (→ page 94)
-  in the SMS list (→ page 59) or the e-mail list (→ page 67)
-  in the missed appointments list (→ page 97)

The icon for the network mailbox is always displayed, provided the number is stored in the telephone. The other lists are only displayed if they contain messages.

To view the messages list: ▶ Press the Message Key .

To open the list:  Select required list. ▶ **OK**

Exception: If you select the **network mailbox**, the number of the network mailbox will be selected (→ page 75). Lists are not opened on the display.

Example

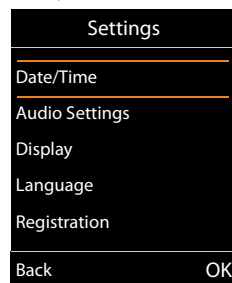

Example

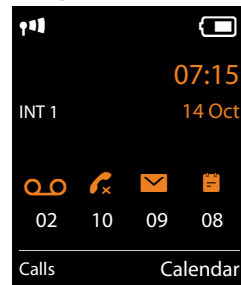

Entering numbers and text

If several number and/or text fields are displayed (e.g. **First Name** and **Surname** in a phonebook entry), the field is automatically activated. The following fields must be activated by navigating with the control key (↵). A field is activated when a cursor is flashing inside it.

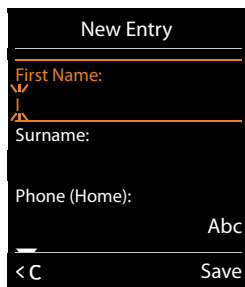

Correcting incorrect entries

- ◆ To delete **characters** before the cursor: press the display key **<C** briefly.
- ◆ To delete **words** before the cursor: press and **hold** the display key **<C**.

Entering text

- ◆ **Letters/Characters:** Multiple letters and characters are assigned to each key between **0-9** and **0-9**. The characters are shown according to the key in a selection line at the bottom left of the display. The selected character is highlighted. Briefly press the key several times in succession to select the required letter/character.
- ◆ **Placing the cursor:** Letters/characters are inserted at the cursor position. You can change the place of the cursor by pressing the control key (↵), or (↵) in fields with multiple rows.
- ◆ **Typing lower case, upper case and numbers:** Press the hash key **#v<** to switch between lower case, upper case or numbers for the **following letters**. When editing a phonebook entry, the first letter and each letter following a space is automatically in upper case.
- ◆ **Special characters:** Press the star key ***o** to open the special characters table. Navigate to the character desired using the star key and press the display key **Insert** to select it.
- ◆ **Special letters:** Umlauts or other marked/diacritic characters can be selected by pressing the corresponding letter several times. See the character table (→ page 143).

Making calls

Note

You can make up to two external calls at the same time via your base, depending on the quality of your DSL connection.

Making an external call

External calls are calls made via the public telephone network (fixed line network or mobile network) and via the Internet (VoIP).



To make an external call, you need to define one of the phone connections as a send connection. You have the following options:

- ◆ Assign a connection to the handset as a send connection permanently (→ page 54).
If necessary, you can use a "fallback" connection via a display key (→ page 49).
- ◆ Select a send connection on the handset each time you make a call.

Permanently assigned send connection

▶ Enter the number. ▶ Press the Talk key  briefly. The number is dialled.

Or:

▶ Press and **hold** the Talk key . ▶  Select a connection. ▶ **Dial** /  ▶ Enter number. The number is dialled approximately 3.5 seconds after the last digit is entered.

Notes

- ◆ If a dialling plan has been defined for the dialled phone number (→ page 121), then the connection specified in the dialling plan will be used to establish the connection instead of the send connection. If the phone number is blocked by a dialling plan, it will not be dialled. **Not possible** is displayed.
- ◆ If you use VoIP to make a call to the fixed line network, you may also have to dial the area code for local calls (depending on the provider). You can avoid having to dial your own area code by entering it in the configuration and activating the **Predial area code for local calls via VoIP** option (see Web configurator).
- ◆ You have activated the **Automatic Fallback to Fixed Line** option with the Web configurator. If an attempt to make a call via a VoIP connection fails, the phone automatically attempts to establish the connection via the fixed line network.
- ◆ Gigaset.net numbers ending with the suffix #9 are automatically dialled via the Gigaset.net connection. The calls are free of charge (→ page 36).

Making calls

Selecting a connection at each call

Prerequisite: Instead of a send connection, "Sel. at each call" is assigned to the handset (→ page 54).



▶ Enter the number. ▶ Press the Talk key . ▶  Select a connection. ▶ Dial / .

Notes

- ◆ You can cancel the dialling process with the End call key .
- ◆ You can see the duration of the call while the call is in progress.
- ◆ If you have registered multiple handsets to the base, you can make **internal** calls free of charge (→ page 80).

Using an alternative connection/connection list on the display key



Prerequisite: You have assigned an "alternative connection" or the list with all configured connections to a display key (→ page 49).

▶ Press the display key **Sel. Line**. ▶  Select a connection. ▶  / **Dial**. ▶ Enter the number.
The number is dialled approximately 3.5 seconds after the last digit is entered.

Any dialling plan that has been defined for the dialled phone number (→ page 121) is ignored. The selected send connection is always used.

Calling an IP address (provider-dependent)



You can also dial an IP address instead of a phone number using VoIP.

- ▶ Press the star key  to separate the sections of the IP address (e.g. 149*246*122*28).
- ▶ If necessary press the hash key  to attach the SIP port number of the person you are calling to the IP address (e.g. 149*246*122*28#5060).



If your VoIP provider does not support the dialling of IP addresses, each part of the address will be interpreted as a normal phone number.

Dialling with the redial list

The redial list contains the 20 numbers last dialled with the handset. You can manage this similarly to your phone's message lists (→ page 29).





- ▶ Open the redial list: **Briefly** press the Talk key .
- ▶  Select an entry. ▶ Press the Talk key . The number is dialled.

If a name is displayed, you can display the corresponding phone number:

- ▶ **View** /  ▶  View next/previous number, if necessary.

If you have assigned a line (e.g. to initiate an external consultation call): ▶ Dial the selected number with **OK**.

Managing entries in the redial list

- ▶  Open the redial list. ▶  Select an entry. ▶ **Options**
- Copy to Directory:** ▶ **OK** ▶ Copy an entry to the phonebook (→ page 83).
- Display number:** ▶ **OK** ▶ Copy a number into the display, change or add to if necessary.
 - ▶ Dial with  or save as a new entry in the phonebook with .
- Delete entry:** ▶ **OK**. The entry is deleted.
- Delete all:** ▶ **OK**. All entries are deleted.

Dialling from the call list

-  ▶  ▶ **OK** ▶  Select the list. ▶ **OK**
- ▶  Select an entry. ▶ . The number is dialled.

Notes

- ◆ You can also bring up the call list using the display key **Calls**, but you must assign a display key accordingly (→ page 50).
- ◆ You can also open the **Missed calls** list using the Message Key .

Example

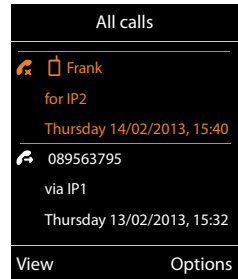

Dialling with the phonebook

-  Open the phonebook. ▶  Select an entry. ▶ 

If multiple numbers are entered:

- ▶  Select a number. ▶ Press the Talk key  or **OK**. The number is dialled.

Note

You can also dial from a public phonebook → page 86, your private online phonebook → page 89 or your Gigaset.net phonebook → page 90.

One touch call

You can set up your phone so that you can dial a specific number when you press **any key on the keyboard**. This allows children, for example, who are unable to enter a number, to call a certain number.

-  ▶  ▶ **OK** ▶  **One Touch Call** ▶ **OK**

Activation: ▶  **On / Off**

Call to: ▶ Enter or change the number.

- ▶ **Save**

The activated One Touch Call appears on the idle display. The saved number is dialled by pressing any key. Cancel dialling with .

The phone is blocked for other calls (including **emergency calls**).

To end one touch call:

- ▶ Press the display key **OFF**. ▶ Press and **hold** the  key.

Or: ▶ Press and **hold** the  key.

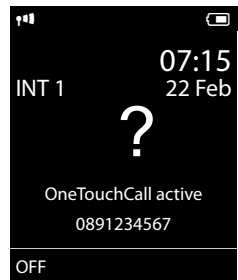

Making calls

Dialling emergency numbers

Dialling plans for emergency numbers (e.g. the **local** police emergency number) are preset on the phone for certain countries. Emergency numbers are dialled by default via the fixed line network. However, you can change the connection through which each emergency number should be called (e.g. if the phone is not connected to the fixed line network) (→ page 121).

Please note: If no dialling plans are defined for emergency numbers and you have set an automatic area code, the area code will also be put in front of the emergency numbers when dialled via a VoIP connection.

Ending a call

▶ Press the End call key .

Accepting a call

An incoming call is indicated by ringing, by a display on the screen and by the flashing Talk key .

Note

Only calls to the receive connections assigned to the handset are signalled (→ page 55).

The following applies if VoIP connections are configured on your base:

- ◆ If you have not assigned the receive connections on your phone, all incoming calls are signalled on all registered handsets.
- ◆ If you have assigned connections but not assigned a connection to any handset as the receive connection, calls on this connection will not be signalled.
- ◆ If a call cannot be assigned to any connection on the phone, this call is signalled on all handsets.

Options for answering the call:

- ▶ Press the Talk key .
- ▶ If **Auto Answer** is switched on (→ page 45), remove the handset from the charging cradle.
- ▶ Accepting a call with the Gigaset L410 handsfree clip: ▶ Press the Talk key on the Gigaset L410.

Prerequisite: The Gigaset L410 must be registered to the base. You can find further information in the Gigaset L410 user guide.

Declining a call:

- ▶ Switch off ringtone: ▶ **Silence**. You can accept the call while it is displayed on the screen.
- ▶ Rejecting a call (only for VoIP connection): ▶ Press the End call key . For a call to the fixed line network connection, only the ringtone is deactivated.

Accepting/rejecting call waiting

If you receive a call while conducting an external call, you will hear the call waiting tone. If the number is transferred, you will see this number or the name of the caller on the display.

To reject a call: ▶ **Reject**

To accept a call: ▶ **Accept**

When you accept a call, the previous call is placed on hold.

Returning to the call on hold: ▶ .

Switching the handsfree mode on/off

If you are going to let someone listen in, you should tell the other participant that this is happening.

Activating/deactivating handsfree mode during a call and when establishing a connection:

▶ Press .

To place the handset in the charging cradle during a call:

▶ Press and hold  for a further 2 seconds while placing the handset in the charging cradle.

For instructions on changing the loudspeaker volume, → page 46.

Switching the microphone on/off (muting)

If you turn the microphone off during a call, your caller can no longer hear you.

▶ Press  to switch the microphone on/off.

Phone number display

Calling Line Identification

The caller's phone number is displayed. If the caller's number is stored in your phonebook, the number type and name are displayed.

No Calling Line Identification

Instead of name and number, the following is displayed:

- ◆ **External:** No number has been transferred.
- ◆ **Withheld:** Caller has withheld Calling Line Identification.
- ◆ **Unavailable:** Caller has not requested Calling Line Identification.

Notes on phone number display for CLIP

By default, the number of the caller is shown on your telephone, → page 132 or

▶ www.gigaset.com/service

Making calls

Transferring the name from the online phonebook

Instead of the phone number appearing in the call display, you can display the name under which the caller is saved in the online phonebook.

Prerequisites:

- ◆ The provider of the online phonebook you have set for your telephone supports this function.
- ◆ You have activated the "Display caller name" function via the Web configurator (→ page 125).
- ◆ The caller has requested Calling Line Identification and has not withheld the function.
- ◆ Your telephone is connected to the Internet.
- ◆ The caller's number is not saved in the handset's local phonebook.

VoIP telephony via Gigaset.net

You can use **Gigaset.net** to make free phone calls via the Internet **directly** to other Gigaset.net users without having to set up an account with a VoIP provider or make any further settings. You simply have to connect your phone to the power supply and to the Internet and, if necessary, enter yourself in the Gigaset.net online phonebook under a name of your choice (→ page 93).

Gigaset.net is a VoIP service provided by Gigaset Communications GmbH to which all users of a Gigaset VoIP device can subscribe.

You can call other participants to Gigaset.net **free of charge**, i.e. there are no telephone charges other than the costs for your Internet connection. Connections to/from other networks are not possible.

Numbers ending with the suffix #9 are automatically dialled via the Gigaset.net connection.

Note

Gigaset.net supports broadband telephony: Gigaset.net calls that you make from your phone with a different broadband-capable terminal have excellent sound quality.

Every Gigaset VoIP device is assigned a Gigaset.net phone number by default (→ page 138). All registered participants are included in the Gigaset.net phonebook, which you are able to access.

An echo service is available for you to check your VoIP connection.

The echo service is available in six languages:

- ◆ 12341#9 (English)
- ◆ 12342#9 (Dutch)
- ◆ 12343#9 (Italian)
- ◆ 12344#9 (French)
- ◆ 12345#9 (German)
- ◆ 12346#9 (Spanish)

After an announcement, the echo service immediately sends back the voice data received from you in the form of an echo.

Exclusion of liability

Gigaset.net is a voluntary service provided by Gigaset Communications GmbH without guarantee or liability for the availability of the network and service provision.

Notes

If you do not use your Gigaset.net connection for six months, it is automatically disabled. You cannot be reached for calls from Gigaset.net.

The connection is reactivated as soon as you:

- ◆ Start a search in the Gigaset.net phonebook
- ◆ Make a call via Gigaset.net (dial a number with #9 at the end) or
- ◆ Activate the connection via the Web configurator.

Gigaset HDSP – telephony with brilliant sound quality

Your Gigaset phone supports the broadband codec G.722. You can therefore use it to make calls with brilliant sound quality (High Definition Sound Performance).

If you register broadband-capable handsets to your base, internal calls between these handsets will also be made via broadband.

The following are prerequisites for broadband connections on your

telephone:

◆ **For internal calls:**

The handsets involved are broadband-capable, i.e. they support codec G.722.

◆ **For external calls via VoIP:**

- You make the call from a broadband-capable handset.
- You have selected codec G.722 for outgoing calls.
- Your VoIP provider supports broadband connections.
- The recipient's phone supports codec G.722 and accepts the establishment of a broadband connection.

Note

The **Gigaset.net** VoIP service (→ page 36) supports broadband connections.



Using provider-specific functions (network services)

Network services depend on and must be requested from your network provider (which may incur additional charges). Network services fall into two distinct groups:

- ◆ Network services that are activated for the following call or all subsequent calls when no call is being made (for example calling anonymously). You can activate/deactivate these network services via the menu .
- ◆ Network services that are activated during an external call e.g. "consultation call" and "setting up conference calls". These services are provided to you during an external call in the options bar (e.g **Ext. Call, Conf.**).

You will find a general description of the features on your network provider's website or at one of their store branches.

Notes

- ◆ To activate/deactivate the following services, a code is generally sent to the telephone network.
 - ▶ After a confirmation tone from the telephone network, press .
- ◆ All functions that can be activated under menu item  are services made available by your network provider. If you require assistance, please contact your network provider.
- ◆ It is not possible to reprogram the network services.
- ◆ Some settings cannot be made simultaneously on multiple handsets. If this is the case, you will hear a negative acknowledge tone.

Configuring general settings for all calls

Anonymous calling – withholding Calling Line Identification

If you withhold your number (CLIR = Calling Line Identification Restriction), your number will not be displayed for the caller. You are calling anonymously.

Note

Anonymous calls are only possible via VoIP connections through providers that support the "anonymous calling" function. You may have to ask your VoIP provider to activate this function.

The setting applies for all calls via the fixed line network and VoIP connections, along with all registered handsets.

 ▶  **Select Services** ▶ **OK** ▶  **All Calls Anonym.** ▶ **Change** (✓ = activated).

To cancel Calling Line Identification for the next call only → page 41.

General Call Forwarding (CD)

When diverting a call, the call is forwarded to another connection.

A distinction is made between

- ◆ Diverting calls internally and
- ◆ Diverting calls to an external phone number

Call Forwarding to an external connection

You can set up Call Forwarding differently for each connection, i.e. for each connection (fixed line network number and VoIP connection), that is assigned to the handset as a receive connection.

  **Select Services** ▶ **OK** ▶  **Call Divert** ▶ **OK** ▶  Select receive connection.
▶ **OK**

Status: ▶  **On / Off**

To Phone Number: ▶ Enter the number to which the call is to be forwarded.

You can specify a different fixed line network, VoIP or mobile number for every connection.

You must specify another Gigaset.net number when diverting a call from your Gigaset.net number.

When: ▶  **All Calls / When Busy / No Answer**

All Calls: Calls are forwarded immediately, i.e. no more calls to this connection are signalled on your phone.

No Answer: Calls are diverted if no one accepts the call within several rings.

When Busy: Calls are forwarded if your line is busy.

▶ **Send**

For diverting calls from the fixed line network:

A connection is established to the telephone network to activate/deactivate Call Forwarding.

▶ After confirmation from the fixed line network, press the End call key .

Please note

Diverting calls to your phone numbers can incur **additional costs**. Please consult your provider.

Internal Call Forwarding

You can divert all **external** calls intended for a receive connection on the handset to a different handset.

 ▶  Select Services ▶ OK ▶  Call Divert ▶ OK ▶  Internal ▶ OK.

Activation: ▶  On / Off

To Handset: ▶  Select internal participant.

No Handset is displayed if internal Call Forwarding has not been set previously or if the previously set handset is no longer registered.

Ring Delay:  None / 10 sec. / 20 sec. / 30 sec.

Delay time for the ring delay. If you prefer to have a delay before the call is diverted, select the length of the delay. If you select **None**, the call is not signalled on the handset and is diverted immediately.

▶ Save

The internal Call Forwarding is single-stage only, i.e. if calls for the handset are diverted to a different handset (e.g. HS1) on which a Call Forwarding is also active (e.g. to HS2), this second Call Forwarding is not activated. The calls are signalled on handset HS1.

Notes

- ◆ Any call for the handset that has been diverted is entered in the call lists.
- ◆ If a call to a receive connection that is only assigned to the handset is diverted to a handset that is not available (e.g. the handset is deactivated), the call is rejected after a short time.

Activating/deactivating call waiting for external calls

If the function is activated, you will hear a call waiting tone during an **external** call to signal that another external caller is trying to get through. If you have CLIP, the number of the waiting caller or the corresponding phonebook entry is shown in the display. The caller will hear the ringing tone.

When call waiting is deactivated, the caller will hear the busy tone if you are already making a call and you are the only participant of this connection.

Prerequisite for calls via VoIP: Parallel VoIP connections are permitted on your telephone (default setting; setting can be changed via the Web configurator).

 ▶  Select Services ▶ OK ▶  Call Waiting ▶ OK

Status: ▶  On / Off

▶ Send

Call waiting is activated/deactivated for all connections to the telephone and all registered handsets.

To activate/deactivate the function for the fixed line network connection, the phone establishes a connection to the exchange to send the relevant code.

▶ After confirmation from the fixed line network, press the End call key .

Special settings for calls via VoIP

Activating/deactivating call transfer – ECT (Explicit Call Transfer)

If the **Transfer (ECT)** function is activated, you can connect two external callers on a VoIP connection with each other by pressing the End call key .

 ▶  **Select Services** ▶ **OK** ▶  **Transfer (ECT)** ▶ **Change** = activated).





Note

You can use the Web configurator to change further settings for the call transfer on a VoIP connection (→ page 124).

Configuring settings for the next call

Activating "anonymous calling" for the next call

You can withhold your phone number for the next call (CLIR = Calling Line Identification Restriction).

 ▶  **Select Services** ▶ **OK** ▶  **Next Call Anonym.** ▶ **OK**
▶ Enter the number or copy from the phonebook. ▶ **Dial** / 

The number is dialled.

Withhold your number for all calls, → page 38.

Configuring settings during an external call

Please note

For VoIP telephony, the services described below are only available if parallel IP connections are permitted.

Consultation calls (external)

You can call a second external caller. The first call is placed on hold.

During an external call:

- ▶ Press the display key **Ext. Call**. The previous call is placed on hold. The caller hears an announcement or music on hold.
- ▶ Enter the second participant's telephone number. The phone number is dialled. You are connected to the second participant.

If the participant does not respond: ▶ **End**. You return to the first participant.

Ending a consultation call

Options ▶  **End active call**

You will be reconnected to the first call participant.

If you have established the consultation call via your fixed line network connection, you can also end the consultation call by pressing the End call key . The connection is briefly interrupted and you will receive a recall. As soon as the receiver is lifted, you are reconnected to the first call participant.

Using provider-specific functions (network services)

This only applies to VoIP connections if the call transfer is not activated by ending the call ("ECT" → page 41 and "Transfer Call by On-Hook" → page 124).

Conference

You can speak to two participants simultaneously.

Prerequisite: You are conducting an external call and have called a second participant (consultation call).

- ▶ Press the display key **Conf**.

You and the two other participants (both marked by the  icon) can hear and speak to each other simultaneously.

Ending a conference call

- ▶ Press the display key **End Conf**.

You return to "call swap" status. You will be reconnected to the participant with whom you started the conference call.

Or:

- ▶  Press the End call key to end the call with both participants.

Prerequisite:

- ◆ You are making the conference call via your fixed line network connection or
- ◆ For VoIP connections: Transfer Call by On-Hook is not activated ("ECT" → page 41; VoIP: Configuring call transfer via VoIP", → page 124).
- ▶  Press the End call key to end the call with both participants.

Each of the participants can end their participation in the conference call by pressing the End call key and replacing the earpiece.

Transferring calls

Transferring a call to an internal participant

You are making an **external** call and would like to transfer it to another handset.

- ▶ Set up an **internal** consultation call (→ page 80). ▶ Press the End call key  (even before the other participant has answered) to transfer the call.

Transferring a call externally – ECT (Explicit Call Transfer)

Prerequisites:

- ◆ The feature is supported by the relevant network provider.
- ◆ You have activated the function **Transfer Call by On-Hook** (→ page 124)) for VoIP with the Web configurator.

You are making an **external** call via a VoIP connection and wish to transfer the call to another external participant.

- ▶ Press the End call key  (during a conversation or before the second participant has answered).

Making cost-effective calls

Make phone calls through a network provider who offers particularly low-cost call rates (preselection; fixed line network only). Using the Internet (VoIP) is the preferred cost-effective way of making calls.

Defining dialling plans

You can also use your phone's cost control function for calls to fixed line network or mobile networks. In addition to your fixed line network connection, you can open accounts with various VoIP providers offering favourable rates for calls to other networks. In the phone configuration, define the best connections (account), e.g. for specific regional, national and mobile network codes, to be used when calls are made (→ Web configurator, User-defined dialling plans – specifying rules for telephony, page 121). Or define the send connection to be used when you actually dial the number (dialling via line selection, → page 32).

Linking a number with a call-by-call number

You can predial call-by-call numbers for calls via your fixed line network connection. Use the call-by-call numbers to select the network of a cost-effective provider for a call. You can store the call-by-call numbers from several network providers in the local phonebook (→ page 83).





Prefix a number with a call-by-call number ("linking"):

- ▶  **Briefly** press. The local phonebook is opened. ▶  Select an entry (call-by-call number). ▶ **Options** ▶  **Display number** ▶ **OK**

The call-by-call number is shown on the display.

- ▶ Enter the phone number.  Press the Talk key.

Or:

- ▶  **Briefly** press again to copy the number from the local phonebook. ▶  Select an entry (→ page 83). ▶ If there are several numbers stored in the entry:  Select the number. ▶ **OK**
- ▶ Press the Talk key . Both numbers are dialled.

Displaying the call duration

The **duration** of each call appears in the display for all external calls

- ◆ During the conversation
- ◆ Until approximately 3 seconds after replacing the earpiece.

Note

The actual duration of the call can vary from what is shown by a few seconds.

Adjusting the telephone settings

The handset and base station are preconfigured, but you can change the settings to suit your individual requirements.

The settings can be changed via the **Settings** menu whilst on a call or in idle status.

Changing the display language

▶ ▶ **OK** ▶ **Language** ▶ **OK** ▶ Select language
▶ **Select** (● =selected)

If you accidentally choose a language you do not understand:

▶ **6** **5** **5** ▶ Select the correct language. ▶ Press the **right** display key.

Setting the display

Setting a screensaver

You can set a screensaver for the display when in idle status. The options are: Analogue Clock, Digital Clock, Image, Info Services.

▶ ▶ **OK** ▶ **Display** ▶ **OK**
▶ **Screensaver** (✓ = activated) ▶ **Edit**

Activation: **On / Off**

Selection: **Digital Clock / Analog Clock / [Images] / Info Services**

View screensaver: ▶ Select screensaver ▶ **View**
▶ **Save**

The screensaver is activated approx. 10 seconds after the display has changed to idle status.

End screensaver: ▶ Press and **hold** the End call key . The idle display will be displayed.

Example

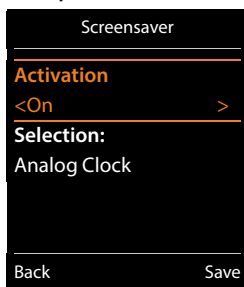

Note

Prerequisites for displaying info services:

- ◆ **Info Services** must be activated via the Web configurator (→ page 125).
- ◆ The telephone must have an Internet connection.

The type of info service available to your phone is set on the Internet on the Gigaset.net server. You can change the setting (→ page 74).

If no information is currently available, the digital time (**Clock**) is displayed instead until information is available again.

Together with the information, display keys that open the Info Centre selection menu can be shown.

Activating/deactivating the information ticker



You can display text information from the Internet that is set for the screensaver **Info Services** as a scrolling message in the idle display.

 ▶  ▶ OK ▶  Display ▶ OK ▶  Info Ticker ▶ Edit (☑ = activated)

The ticker starts as soon as the telephone changes to idle status. If a message is shown in the idle display, the information ticker is not displayed.

Setting the colour scheme

You can set the display to show a dark or a light background.

 ▶  ▶ OK ▶ Display ▶ OK ▶ Colour Schemes ▶ OK ▶  Colour Scheme 1 / Colour Scheme 2 ▶ Select (● = selected)

Setting the display backlight

The display backlight is always activated when the handset is not in the base/charging cradle or when a key is pressed. Any **digit keys** pressed appear on the display for pre-dialling.

You can activate/deactivate the display backlight for idle status:

 ▶  ▶ OK ▶  Display ▶  Backlight ▶ OK

In Charger: ▶  On / Off

Out of Charger: ▶  On / Off

▶ Save

Note

The **On** setting can significantly reduce the standby time of the handset.

Activating/deactivating Auto Answer

When set to Auto Answer, the handset accepts an incoming call as soon as you remove it from the charging cradle.

 ▶  ▶ OK ▶  Telephony ▶ OK ▶ Auto Answer ▶ Change (☑ = activated).

Regardless of the **Auto Answer** setting, the connection ends as soon as you place the handset back in the charging cradle. Exception: Press and hold  for a further 2 seconds while placing the handset in the charging cradle.

Changing the handsfree/earpiece volume

You can set the volume of the earpiece and speaker at 5 levels independently of each other.

Handset Volume

Or:

 ▶  ▶ OK ▶  Audio Settings ▶ OK ▶ Handset Volume ▶ OK

▶  Set earpiece volume. ▶  Scroll to the **Speaker:** line.

▶  Set speaker volume. ▶ **Save**

Setting the volume during a call: ▶  ▶  Select the volume. ▶ **Save** (The setting is automatically saved after approx. 3 seconds.)

If  is assigned to another function:

▶ **Options** ▶  **Volume** ▶ OK ▶ Make the setting.

Setting the earpiece profile

You can set various **earpiece** profiles to optimally adapt your phone to your environment. Check which is the most comfortable for you.

Earpiece Profiles: High and Low. The default is **Low**.

 ▶  ▶ OK ▶  Audio Settings ▶ OK ▶  Earpiece Profiles ▶ OK

▶  Select profile ▶ **Select** (● = selected)

Setting the handset ringtones

Setting the ringtone volume

 ▶  ▶ OK ▶  Audio Settings ▶ OK ▶  Ringtones (Handset) ▶ OK ▶ Volume ▶ OK

 For internal calls and alarms / External Calls





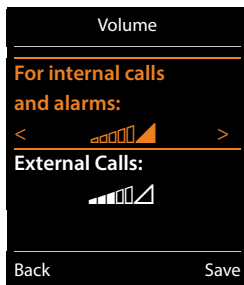

 Volume can be set at 5 levels or crescendo (increasing volume).

▶ **Save**

Example





Setting the ringtone

-  ▶  ▶ OK ▶  **Audio Settings** ▶ OK ▶  **Ringtones (Handset)** ▶ OK
 ▶  **Melodies** ▶ OK ▶  Select the connection.
 You can set different ringtones for:
- internal calls and anniversaries
 - external calls to each individual receive connection of the phone
(**Landline, IP1 to IP6, Gigaset.net**)
- Or select the same ringtone for **All calls**.
- ▶  Select each ringtone/melody. ▶ **Save**

Activating/deactivating the ringtone

Activating/deactivating the ringtone **permanently**: ▶ Press and **hold** the star key .

When the ringtone is deactivated,  appears in the status bar.

Deactivating the ringtone for the **current call**: ▶ Press **Silence** or .

Activating/deactivating the alert tone (beep)

You can activate an alert tone (beep) instead of the ringtone.

▶ Press and **hold** the star key  and **within three seconds** press the display key **Beep**.

When the alert tone is activated,  appears in the status bar.

Deactivating the alert tone: ▶ Press and **hold** the star key .

Setting time-controlled signalling for external calls

You can specify a time period when you do not want the handset to signal external calls e.g. during the night.

Prerequisite: Date and time are set.

 ▶  ▶ OK ▶  **Audio Settings** ▶ OK ▶  **Ringtones (Handset)** ▶ OK ▶ **Time Control**

For external calls: ▶  On / OFF

For external calls = On:

Suspend ring. from / Suspend ring. until: ▶ Enter the start and end of the period in 4-digit format.

▶ **Save**

Example

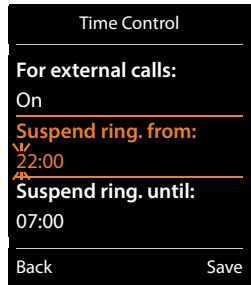

Note

During this period, your phone will continue to ring for numbers to which you have assigned a VIP group in the phonebook.

Activating/deactivating the ringtone for anonymous calls



You can set your handset not to ring if a caller withholds their number. The call is only signalled on the display.

 ▶  ▶ OK ▶  **Audio Settings** ▶ OK ▶  **Ringtones (Handset)** ▶ OK ▶ **Anon. Calls Silent** ▶ **Change** = ringtone is deactivated for anonymous calls).

Adjusting the telephone settings

Activating/deactivating the ringtone

You can deactivate the ringtone on your handset before you answer a call or when the handset is in idle status; the ringtone can be deactivated permanently or just for the current call. The ringtone cannot be re-activated while an external call is in progress.

- ◆ Deactivating the ringtone permanently: ▶ Press and **hold** the star key . The  icon appears in the display.
- ◆ Reactivating the ringtone: ▶ Press and **hold** the star key .
- ◆ Deactivating the ringtone for the current call: ▶ **Silence**

Activating/deactivating the alert tone

You can activate an alert tone ("Beep") instead of the ringtone.

- ▶ Press and **hold** the star key . ▶ Within 3 sec.: Press the display key **Beep**.

A call will now be signalled by **one** short alert tone. The display shows .

Activating/deactivating advisory tones

Your handset uses advisory tones to tell you about different activities and statuses. These advisory tones can be activated/deactivated independently of each other.

-  ▶  ▶ **OK** ▶  **Audio Settings** ▶ **OK** ▶  **Advisory Tones** ▶ **OK**

Key Tones:  **On / Off**

Tone when keys are pressed.

Confirmation:  **On / Off**

Confirmation/error tone after making entries, advisory tone when a new message has been received.

Battery:  **On / Off**

Warning tone when there are fewer than 10 minutes of talktime remaining (every 60 seconds). There is no battery warning when the baby monitor is activated.

- ▶ **Save**

Activating/deactivating music on hold

You can activate/deactivate music on hold for external calls during consultation and forwarding.



-  ▶  ▶ **OK** ▶  **Audio Settings** ▶ **OK** ▶  **Music on hold**
▶ **Change**  = activated)

Resetting a handset to the default settings



You can reset any individual settings and changes that you have made.

The following settings are **not** affected by a reset

- ◆ Registering the handset to the base
- ◆ Date and time
- ◆ Directory entries, the call lists, the SMS lists

-  ▶  ▶ **OK** ▶  **System** ▶ **OK** ▶  **Reset Handset** ▶ **OK** ▶ **Yes**

Quick access to numbers and functions

- ◆ **Number keys:** The keys **0**  and **2**  to **9**  can be assigned to a **number from the phonebook**.
- ◆ **Display keys:** The left and right display keys have a **function** preset by default, but the keys can be re-assigned (→ page 50).

You can then dial the number or start the function by simply pressing a key.

Assigning a number to digit keys (quick dial)

Prerequisite: No number has been assigned to the digit key.

- ▶ Press and **hold** the digit key

Or:

- ▶ **Briefly** press the digit key. ▶ Press the display key **Quick Dial**.

The phonebook is opened.

- ▶  Select an entry. ▶ **OK** ▶  Select number ▶ **OK**

The entry is saved to the corresponding digit key.

Note

If you delete or edit the entry in the phonebook at a later date, this will not affect the assignment to the number key.

Selecting numbers/changing an assignment

Prerequisite: A number has been assigned to the digit key.

When the handset is in idle status

Dialling a number:

- ▶ Press and **hold** the digit key. The number is dialled immediately.

Or:

- ▶ **Briefly** press the digit key. ▶ Press the left display key with the number/name (abbreviated if necessary).

Changing digit key assignments:

- ▶ **Briefly** press the digit key. ▶ **Change**. The phonebook is opened.
Changing the assignment: ▶ Select entry ▶ **OK** ▶ Select the number if necessary ▶ **OK**.
Delete the assignment: ▶ Press the display key **Clear Key**.

Assigning display keys, changing assignments

- ▶ Press and **hold** the left or right display key. The list of possible key assignments is opened.
 - ▶ Select function. ▶ **OK**.

The following functions are available:

Baby Monitor:	Set and activate/deactivate the baby monitor (→ page 100)
Alarm Clock:	Set and activate/deactivate the alarm clock (→ page 97)
Calendar:	Open calendar (→ page 97)
One Touch Call:	Set up one touch call (→ page 33).
Redial:	Show redial list (→ page 32).
eMail:	Open the e-mail submenu for receiving and reading e-mail notifications (→ page 67)
More Functions...	You can also choose further functions:
Send Connection	Assign an alternative send connection to a key. <ul style="list-style-type: none">▶ Select a connection as a (further) send connection for the handset. ▶ OK Use this display key if you wish to use the alternative send connection (temporarily) for the next call (instead of the send connection for the handset) (→ page 20).
Line Selection	Assign the list of connections for your phone to a key. Select the send connection for each call from the list (→ page 32).
Call Lists	Show call list (→ page 94).
Call Divert	Activate/deactivate Call Forwarding (→ page 39)
eMail	Open the e-mail submenu for receiving and reading e-mail notifications (→ page 67)
Info Centre	Start the Info Centre and open the list of available information services – go online (→ page 72).
Network directories	Display list of network directories (→ page 86)
Central Net Dir.	Display company directory, if available
public network directory	Display personal online phonebook if you have set one up (→ page 89)

Starting a function

With the telephone in idle status: ▶ **Briefly** press the display key. The assigned function is performed.

Configuring the system settings

You can make the following settings via the menu on the relevant handset or on a registered Gigaset C430H, E630H, C620H, S820H, SL910H, SL930H handset or via the Web configurator on the phone.

Setting the date and time manually

To ensure you have the correct time for incoming calls and to use the alarm clock and calendar, the date and time must be set.

Note

The address of a time server on the Internet is stored on your phone. The date and time are taken from this time server provided that the phone is connected to the Internet and synchronisation with the time server is activated. Manual settings are overwritten in this case.

If the date and time have not yet been set on the handset, the display key **Time** appears.

- ▶ Press the display key **Time**.

Or:

 ▶  ▶ **OK** ▶  **Date/Time** ▶ **OK**

Date: ▶ Enter the day, month and year in 8-digit format,
e.g. for 14/01/2011.





Time: ▶ Enter hours and minutes in 4-digit format,
e.g. for 07.15.

- ▶ **Save**

Changing the system PIN

Protect the system settings of your phone with a PIN known only to you. You have to enter the system PIN if you register or de-register a handset, change local network settings, perform a firmware update or reset the phone to default settings.

You can change the 4-digit system PIN of the base (default setting: **0000**).

 ▶  ▶ **OK** ▶  **System** ▶ **OK** ▶  **System PIN** ▶ **OK** ▶ Enter the current system PIN if necessary. ▶ **OK** ▶ Enter the new system PIN. ▶ **OK**

Setting your own area code

Your area code (international and local area code) must be saved on the phone before you can transfer phone numbers (e.g. in vCards).

Some of these numbers are already preset.

▶ ▶ OK ▶ Telephony ▶ OK ▶ Area Codes ▶ OK

- ▶ Check the (pre)set area code.
- ▶ Change the number: Select/change the input field.
 - ▶ Navigate in the input field. ▶ Delete the number.
 - ▶ Enter the number. ▶ Save

Example:

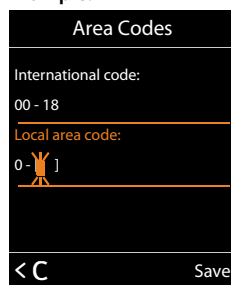

Activating/deactivating music on hold

▶ ▶ OK ▶ Audio Settings ▶ OK ▶ Music on hold
▶ Change (= activated).

Setting the IP address of the base in LAN

Prerequisite: Your base is connected to a router or a PC (→ page 13).

An IP address is required in order for the LAN to "recognise" your phone.

The IP address can be assigned to the phone automatically (by the router) or manually.

- ◆ If the address is assigned **dynamically**, the router's DHCP server automatically assigns an IP address to the phone. The IP address can be changed according to router settings.
- ◆ With manual/**static** assignment, you assign a static IP address to the phone. This may be necessary depending on your network configuration (e.g. if your phone is connected directly to a PC).

Note

To assign the IP address dynamically, the DHCP server on the router must be activated. Please also read the user guide for your router.

▶ ▶ OK ▶ System ▶ OK ▶ Local Network ▶ OK
▶ If system PIN is something other than 0000: Enter the system PIN. ▶ OK

IP Address Type: ▶ Static / Dynamic

With IP Address Type Dynamic:

The following fields show the current settings that the phone obtained from the router. These settings cannot be changed.

With IP Address Type Static:

You must manually define the IP address and the subnet mask for the phone as well as the default gateway and DNS server in the following fields.

IP Address: ▶ Enter the IP address (overwriting the current settings).

The default is 192.168.1.2. For information on the IP address, see the glossary (→ page 149).

Subnet Mask: ▶ Enter the subnet mask (overwriting the current settings).

The default is 255.255.255.0.

For information on the subnet mask, see the glossary (→ page 154).

DNS Server: ▶ Enter the IP address of the preferred DNS server.

The DNS server (Domain Name System, → page 146) converts the symbolic name of a server (DNS name) into the public IP address for the server when the connection is made.

You can specify your router's IP address here. The router forwards phone address requests to its DNS server.

The default is 192.168.1.1.

Default Gateway: ▶ Enter the IP address of the standard gateway (→ page 148).

The local network is connected to the Internet via the standard gateway. This is generally your router. Your phone requires this information to be able to access the Internet.

The default is 192.168.1.1.

▶ **Save**

Note

You can make local network settings also via the Web configurator (→ page 116).

Configuring VoIP connections

Note

If auto configuration is used to download the VoIP data to your phone (provider-specific, → page 17), the VoIP wizard is not available. In this case you cannot change the VoIP settings manually.

You can configure up to 6 VoIP connections to your phone, i.e. you can assign up to 6 VoIP phone numbers to your phone.

You need to set up an IP account (VoIP account) with a VoIP provider for each connection. You must save the access data for this IP account on your phone. The VoIP wizard will help you to do this.

Launching the IP wizard:

 ▶  ▶ **OK** ▶  **Telephony** ▶ **OK** ▶  **VoIP Wizard** ▶ **OK**

You will see the following in the display:

The procedure for the VoIP wizard is described on page 15.

Each time you run the VoIP wizard you can configure/reconfigure **one** VoIP connection (IP account).

▶ Restart the VoIP wizard if you wish to configure/reconfigure another VoIP connection.

Note

You can also use the Web configurator to configure and manage VoIP connections (→ page 118).



Automatic update for the VoIP provider settings

After the first download of the VoIP provider settings, your phone will check daily whether a newer version of the file for your VoIP provider is available via the Internet on the configuration server.

Auto configuration has been used to download VoIP settings (→ page 17)

If there is new configuration data, this is automatically downloaded to your phone (without notification).

Manual VoIP configuration with the IP wizard

If there is new provider data, the idle display on the handset displays the message **New profile available**.

▶ Confirm prompt by pressing **Yes**. ▶ Enter the system PIN if required. ▶ **OK**

The new data for your VoIP provider will be downloaded and saved on the phone.

If you respond to the prompt with **No**, the handset returns to idle status. Your telephone will not remind you of this new profile again. The message will only be shown again if a newer version of the provider data is available.

A profile update will only be started if no other profile or firmware update is taking place at the time.

Assigning send and receive connections to internal participants

If you have several connections configured for your telephone system, you can do the following for each internal participant:



- ◆ Assign a send connection or allow the internal participant to select the connection for each external call (select line).
- ◆ Assign one or several receive connections. Only calls received via one of the assigned connections are signalled on the device.

Assigning a send connection

Prerequisite: You have configured at least one VoIP connection on your phone.

 ▶  ▶ **OK** ▶  **Telephony** ▶ **OK** ▶  **Send Connections** ▶ **OK**

A list of handsets is displayed.

- ▶  Select the handset that should be assigned a new send connection. ▶ **OK**
- ▶  Choose a connection as the send connection. All configured connections are offered with the names you have set. ▶ **Save**

If more than one connection is configured, **Sel. at each call** is also offered. For each call, you can then select a connection over which the relevant conversation should be established.

The Gigaset.net connection is not included in the selection for the send connections. Gigaset.net numbers (suffix #9) are automatically dialled via Gigaset.net.

Note

If the send connection on a handset is deleted or deactivated, the fixed line network connection is assigned to it as the send connection.

Assigning receive connection(s)

Prerequisite: Several connections are configured for your phone.

 ▶  ▶ **OK** ▶  **Telephony** ▶  **Rec. Connections** ▶ **OK**

The internal participants (handsets) are displayed.

▶  Select the internal participants that should be assigned new receive connections. ▶ **OK**

All configured connections and the Gigaset.net connection are displayed.

▶  Select **Yes** if you want the relevant connection to be the receive connection for the internal participant. Select **No** if it should not be the receive connection.

▶  Switch to the next connection.

▶ Repeat the steps for each connection. ▶ **Save**

Notes

- ◆ If a new connection is configured, it is assigned as the receive connection to all internal participants and answer machine **Answer Machine 1**.
- ◆ If a connection is not assigned as the receive connection to any internal participant, calls on this connection will not be signalled.

Updating the phone firmware

If necessary, you can update your phone's firmware.

The firmware update is downloaded directly from the Internet by default. The relevant web page is preconfigured in your phone.

Prerequisite:

- ◆ The phone is connected to the Internet (i.e. connected to a router, → page 13).
- ◆ The phone is in idle status i.e. no calls are being made, there is no internal connection between the registered handsets, the base menu is not open in any of the handsets.

Starting the firmware update manually

 ▶  ▶ **OK** ▶  **System** ▶  **Update Firmware** ▶ **OK** ▶ Enter system PIN. ▶ **OK**

The phone establishes a connection to the Internet. ▶ Start the firmware update with **Yes**.

Notes

- ◆ The firmware update can take up to six minutes, depending on the quality of your DSL connection.
- ◆ When updating from the Internet, checks are made to ensure that no newer version of the firmware exists. If this is not the case, the operation is terminated and a message is issued to that effect.

Updating firmware automatically

Your phone will check daily whether a newer firmware version is available from the Internet on the configuration server. If firmware updates are available, the message **New firmware available** is displayed in the idle display of the handset.

▶ Press the display key **Yes** to confirm the prompt.

The firmware will be downloaded to your phone.

Note

If the telephone is not connected to the Internet at the time when the check for new firmware is to be performed (e.g. because the router is deactivated), the check is performed as soon as the phone is reconnected to the Internet.

You can deactivate the automatic version check via the Web configurator.









Restarting the base

 ▶  ▶ **OK** ▶  **System** ▶ **OK** ▶  **Base Restart** ▶ **OK**

This is restarted. This process takes about 20 seconds.

Checking the base MAC address

Depending on your network configuration, you may have to enter your base MAC address in your router's access control list, for example. You can check the MAC address on the handset.

 ▶        The MAC address is displayed.

Returning to idle status: ▶ **Back**

Restoring phone to default setting

The individual settings are reset.

Resetting the base via the menu

When the settings are reset

- ◆ Handsets are still registered
- ◆ The system PIN is not reset

The following settings in particular are reset to the default settings (you can change the settings marked "*") via the Web configurator):

- ◆ The entered VoIP connections (are deleted)
- ◆ The assignment of send and receive connections
- ◆ Audio settings for VoIP connections *)
- ◆ DTMF settings *)
- ◆ Own area code
- ◆ Settings for the local network
- ◆ The names of the handsets
- ◆ SMS settings (e.g. SMS centres)
- ◆ **Eco Mode** and **Eco Mode+** are deactivated
- ◆ PABX connection settings
- ◆ Digit and display key assignments as well as the  key
- ◆ Settings for network services: Call Forwardings

The following lists are deleted:

- ◆ SMS lists
- ◆ Call lists

 ▶  ▶ OK ▶  **System** ▶ OK ▶  **Base Reset** ▶ OK ▶ Enter system PIN. ▶ OK ▶ Yes

After the reset, the base is restarted. The restart takes around ten seconds.

The installation wizard is launched (→ page 14).

Resetting the base using a key on the base

As with resetting the base via the menu, all individual settings are reset. The **system PIN will also be reset to "0000"** and all **handsets** registered above and beyond the delivery scope **are deregistered**.

Note

For instructions on re-registering the handsets after a reset (where applicable) → page 78.

- ▶ Remove the cable connections from the base station to the router and fixed line network.
- ▶ Remove the base station mains unit from the socket.
- ▶ Press and **hold** the registration/paging key (→ page 3).
- ▶ Plug the power adapter back into the power socket.
- ▶ Press and hold the registration/paging key (at least 20 seconds).
- ▶ Release the registration/paging key. The base has now been reset.

Operating a repeater

You can use the Gigaset Repeater to increase the range of your Gigaset handset.

The function and setting of your repeater depends on the repeater version used. The repeater version can be identified by the item number on the product label:

Gigaset Repeater (earlier than version 2.0) S30853-S601-...

Gigaset Repeater 2.0 S30853-S602-...

For additional information, see the repeater user guide and the website at

www.gigaset.com/gigasetrepeater

Gigaset Repeater (earlier than version 2.0)

Prerequisites:

- ◆ ECO DECT function **Maximum Range** must be activated.
- ◆ ECO DECT function **No Radiation** must be deactivated.
- ◆ Encryption must be deactivated:

 ▶  ▶ OK ▶  System ▶ OK ▶  Encryption ▶ Change = deactivated)

Modifying the ECO DECT functions → page 96.

Registering a repeater:

- ▶ Connect the repeater to the mains power supply. ▶ Press and **hold** the Registration/paging key on the base (min. 3 sec.). ▶ The repeater registers automatically.

You can register up to 6 Gigaset repeaters.

Gigaset Repeater 2.0

Registering the Gigaset Repeater 2.0:

- ▶ Connect the repeater to the mains power supply. ▶ Press and **hold** the Registration/paging key on the base (min. 3 sec.). ▶ The repeater registers automatically.

You can register a maximum of 2 Gigaset Repeaters 2.0.

The ECO DECT function **Maximum Range** is activated and the **No Radiation** is deactivated. The settings cannot be changed whilst the repeater is registered.

De-registering the Gigaset Repeater 2.0:

-  ▶  ▶ OK ▶  System ▶ OK ▶  Repeater ▶ OK ▶  Select repeater.
 - ▶ De-reg.

SMS (text messages)

You can use your telephone to send and receive SMS messages via the fixed line network and VoIP.

You must specify the line via which SMS are sent. You can receive SMS messages (abbreviated: SMS) via all of your phone's connections except for Gigaset.net.

Your telephone is delivered ready to send SMS messages as soon as the phone is connected to the fixed line network. If you do not specify any settings the SMS messages are sent via the fixed line network.

Prerequisites:

- ◆ Calling Line Identification is enabled for the VoIP connections/fixed line network via which you wish to send/receive SMS messages. Calling Line Identification must not be withheld → page 38.
- ◆ Your network provider supports the SMS service (information on this is available from your network provider).
- ◆ To receive SMS messages, you must be registered with your SMS service provider. This happens automatically when you send the first SMS via the provider's service centre.

Writing/sending SMS

Write an SMS

 ►  Messaging ► OK ►  SMS ► OK ►  New SMS ► OK
 ► Write an SMS.

Send an SMS

Options ►  Send ► OK ►  SMS ► OK

- **Send SMS to:** ►  Select number with dialling code (even if you are in that area) from the phonebook or enter directly. If sending SMS messages to an SMS mailbox, add the mailbox ID to the **end** of the number.
- **Send**

Notes

- ◆ If you are interrupted by an external call while writing an SMS, the text is automatically saved in the draft list.
- ◆ If the memory is full, or if the SMS function is being used by a handset, the operation is cancelled. A corresponding message appears in the display. Delete SMS messages you no longer require or send the SMS later.

SMS (text messages)

SMS status report

Prerequisite: Your network provider supports this feature.

If you have activated the status report, you will receive an SMS with a confirmation message after sending.

Activating/deactivating a status report

  **Messaging** ▶ **OK** ▶  **SMS** ▶ **OK** ▶  **Settings** ▶ **OK** ▶  **Status Report**
▶ **Change** ( = activated).

Reading/deleting status report/saving number to phonebook

- ▶ Open the incoming message list (→ page 62) ▶  **Select SMS** (with **State OK** or **State not OK**). ▶ **Read**
- ◆ Delete an entry: ▶ **Options** ▶  **Delete entry** ▶ **OK**
- ◆ Copy to phonebook: ▶ **Options** ▶  **Copy to Directory** ▶ **OK**
- ◆ Delete entire list: ▶ **Options** ▶  **Delete List** ▶ **OK**

Draft message list

You can save an SMS in the draft list and edit and send it later.

Saving SMS in the draft message list

▶ Write an SMS. ▶ **Options** ▶  **Save** ▶ **OK**

After saving, the SMS editor with your SMS will be displayed again. You can continue writing the text and save it again. The SMS that was saved previously will be overwritten.

Opening the draft list



 ▶  **Messaging** ▶ **OK** ▶  **SMS** ▶  **Draft**

The first list entry is displayed, for example:

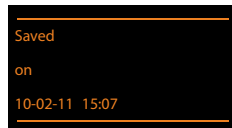
If the entry has been saved with the phone number, e.g. when an SMS was saved from the incoming message list, the number is displayed in the first line.



Reading an SMS

▶ Open the draft message list. ▶  **Select SMS**. ▶ **Read**. The text is displayed. ▶ Scroll line by line with .

Deleting an SMS

▶ Open the draft message list. ▶  **Select SMS**. ▶ **Options** ▶  **Delete entry** ▶ **OK**.

Writing/changing an SMS

- ▶ Open SMS in the draft message list. ▶ **Options**
- ◆ Send saved SMS: ▶ **Send**
- ◆ Edit the text of the saved SMS and then send it: ▶ **Edit** ▶ **Send**
The SMS that was saved previously remains unaltered in the draft message list.
- ◆ Change the character set (one SMS is opened for reading): ▶ **Character Set** ▶  **Select the character set to be used to show the text** (→ page 62). The setting only applies to the current SMS.

Deleting draft message list

- ▶ Open the draft message list. ▶ **Options** ▶  **Delete List** ▶ **OK** ▶ Confirm with **Yes**. The list is deleted.

Sending SMS messages to an e-mail address

If your service provider supports the **SMS to e-mail** feature, you can also send your SMS messages to e-mail addresses.

The e-mail address must be at the beginning of the text. You must send the SMS to your SMS service centre's e-mail service.



 ▶  **Messaging** ▶ **OK** ▶  **SMS** ▶  **New SMS**

- ▶ Enter SMS text. ▶ **Options** ▶  **Send** ▶ **OK** ▶ **eMail** ▶ **OK**
 - ▶ If the number of the e-mail service is not entered (→ page 64), enter the number of the e-mail service.
- ▶ **Send**

Sending an SMS as a fax

You can also send an SMS to a fax machine.

Prerequisite: Your network provider supports this feature.

- ▶ Write an SMS. ▶ **Options** ▶  **Send** ▶ **OK** ▶  **Fax** ▶ **OK**
 - ▶  Select number from the phonebook or enter it manually. Enter the number with the local area code (even if you are in the same area).
- ▶ **Send**

Receiving an SMS

All received SMS messages are saved in the incoming message list. Linked SMS messages are displayed as **one** message. If this is too long or is not transferred completely, it is split into individual messages. Since an SMS remains in the list even after it has been read, you should **regularly delete SMS messages from the list**.

The display tells you if the SMS memory is full.

- ▶ Delete unnecessary SMS messages (→ page 62).



Note

Each incoming SMS on the fixed line network connection is signalled by a single ring (ringtone as for external calls). If you accept the "call", the SMS is lost. To prevent this ring, suppress the first ringtone for all external calls (→ page 65).

Incoming message list

The incoming message list contains:

- ◆ All received SMS messages regardless of the connection they were intended for. All received SMS messages are displayed on all handsets.
- ◆ SMS messages that could not be sent due to an error.

New SMS messages are signalled by the  icon on the display, the flashing Message Key  and an advisory tone.

SMS (text messages)

Opening the incoming message list with the key

- ▶ Press .

The incoming message list displays the number of entries:

bold: new entries

regular font: old entries

- ▶ To open the list: ▶ **OK**

Every entry in the list contains:

- ◆ The number or name of the sender
- ◆ The receive connection to which the SMS is addressed
- ◆ The date of receipt.



SMS: (2)

Opening the incoming SMS list via the SMS menu



-  ▶  Messaging ▶ **OK** ▶  SMS ▶  Incoming ▶ **OK**

Deleting the incoming message list

All new and old SMS messages in the list are deleted.

- ▶ Open the incoming message list. ▶ **Options** ▶  Delete List ▶ **OK** ▶ Confirm with **Yes**.
The list is deleted.

Reading an SMS

- ▶ Open the incoming message list. ▶  Select SMS. ▶ **Read**
The text is displayed. Scroll line by line with .



After you have read a new SMS, it is given the status "old" (is no longer shown in bold).

Deleting an SMS

- ▶ Open the incoming message list. ▶  Select SMS. ▶ **Options** ▶ **Delete entry** ▶ **OK**



Changing the character set

If you cannot see any text or can only see incomprehensible symbols, the SMS may have been written with a different character set (Cyrillic, Greek etc.).

- ▶ Read the SMS. ▶ **Options** ▶  **Character Set** ▶ **OK** ▶  Select character set
(e.g. Turkish, Greek) ▶ **Select** (● = activated).

The text is shown in the selected character set. The setting only applies to the current SMS.

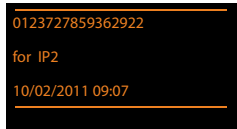

Replying to or forwarding SMS messages

- ▶ Read the SMS. ▶ **Options**
 - ◆ Write and send a new SMS to the sender's number: ▶  **Reply** ▶ **OK**
 - ◆ Change the text of the SMS: ▶  **Edit** ▶ **OK**
 - ◆ Answer or send back amended SMS: ▶ **Options** ▶  **Forward** ▶ **OK**



0123727859362922
for IP2
10/02/2011 09:07

Adding the number of the message sender to the phonebook

- ▶ Open the incoming message list. ▶  Select SMS. ▶ **Options** ▶  **Copy to Directory** ▶ **OK**
- ▶ Create a new entry or complete an existing entry (→ page 84).

Note

An attached mailbox identifier is added to the phonebook.

Copying/dialling numbers from an SMS

- ▶ Read the SMS and scroll to the telephone number. The digits are highlighted.
- ▶  ▶ Complete the entry (→ page 84).

Or:

- ▶ Press the Talk key  to select the number.

If you also want to use the number to send an SMS:

- ▶ Save the number with the local area code (dialling code) in the phonebook.

If an SMS contains several numbers, the next number will be highlighted if you scroll down until the first number disappears from the display.

Notes

- ◆ The + symbol is not transferred for international area codes.
 - ▶ You should then enter '00' at the start of the number.
- ◆ If there are no more entries available in the phonebook, you can only overwrite or modify an existing entry.

SMS with vCard

The vCard is an electronic business card. It is indicated by the  icon in the SMS text.

A vCard can include:

Name, home number, work number, mobile number, birthday

Individual entries in a vCard can be saved to the phonebook one after the other.

Opening the vCard

- ▶ Read the SMS containing the vCard. ▶ **View**
- To return to the SMS text: ▶ **Back**

Or:

- ▶  Select number. ▶ **Save**

When you save a number, the phonebook is opened automatically. The number and name are copied. If a birthday is entered on the vCard, the date is copied to the phonebook as an anniversary.

- ▶ If necessary, edit the entry in the phonebook and save it. You will return to the vCard automatically.

Receiving notifications via SMS

You can be notified via SMS about missed calls .

Prerequisite: The caller's number (CLI) must have been transmitted in the missed call.

Notification is sent to your mobile or another phone with SMS functionality.

You only need to save the telephone number to which you want to send the notification.

Note

Your provider will usually charge for SMS notifications.

  **Messaging** ▶ OK ▶  **SMS** ▶ OK ▶  **Settings** ▶ OK ▶  **Notification** ▶ OK

To : ▶ Enter the number (including area code) to which the SMS is to be sent.

For missed calls: ▶  **On / Off**

For AM messages: ▶  **On / Off**

On = Notification SMS is sent.

▶ **Save**

Caution

Do **not** enter your own number for notification of missed calls. This can create an endless loop that will incur charges.

Setting the SMS centre/defining the send line

Text messages are exchanged between SMS centres that are operated by service providers. You must enter the SMS centre in your device through which you wish to send and receive. You can receive SMS from **every** SMS centre that is entered if you have registered with your service provider. This happens automatically when you send the first SMS via the relevant service centre.

Your SMS messages are sent via the **SMS service centre** that is entered as the **active send centre**. However, you can activate any other SMS centre as the active send service centre to send a current message (→ page 64).

If no SMS service centre is entered, the submenu **SMS** only consists of the entry **Settings**. Enter an SMS service centre (→ page 64).

Entering/changing the SMS service centre

▶ You should find out about the services and special functions offered by your service provider **before you make a new application** and/or before you delete pre-configured call numbers.

  **Messaging** ▶ OK ▶  **SMS** ▶ OK ▶  **Settings** ▶ OK ▶ **Service Centres** ▶ OK

▶  **Select SMS centre.** ▶ **Edit**

Active Send: ▶  Select **Yes** if SMS should be sent via the SMS service centre. For the SMS centres 2 to 4, the setting only applies to the next SMS.

SMS Service Centre Number: ▶ Enter the number of the SMS service.

eMailService no.: ▶ Enter the number of the e-mail service.

Send via: ▶ Select the fixed line network or VoIP connection that you want to use to send the SMS messages.

▶ **Save**

Notes

- ◆ If you have selected a VoIP connection and the attempt to transmit the SMS messages fails, the SMS is stored in the incoming message list with error status. Even if you have activated the **Automatic Fallback to Fixed Line** option (→ Web configurator), your telephone will not attempt to send the SMS via the fixed line network.
- ◆ If the selected send connection is deleted from the configuration, the fixed line network connection is used.

Sending an SMS via another SMS service centre

- ▶ Select **Service Centre 2, 3 or 4** and activate as the active send service centre.
(Set **Active Send = Yes**). **Service Centre 1** is automatically deactivated as the send service for the next SMS.
- ▶ Send an SMS.

This setting only applies to the next SMS to be sent. After that the setting **Service Centre 1** is used again.

Activating/deactivating first ringtone muting

Every SMS addressed to your fixed line network connection is indicated by a single ring. To prevent this ring, suppress the first ringtone for all external calls on your fixed line network connection.

 ▶ * 0 # 0 5 # 1 9

 **OK** Make the first ringtone audible.

 **OK** Suppress the first ringtone.

Activating/deactivating SMS function

If you deactivate the SMS function, you cannot send or receive any further SMS messages with your phone.

The settings you have made for sending and receiving SMS messages (e.g. the numbers of the SMS service centres) and the entries in the incoming and draft lists are saved even after deactivation.

 ▶ * 0 # 0 5 # 2 6

 **OK** Deactivate the SMS function.

 **OK** Activate the SMS function (default setting).

SMS troubleshooting

Error codes when sending

E0	Calling Line Identification permanently withheld (CLIR) or Calling Line Identification not activated.
FE	Error occurred during SMS transfer.
FD	Connection to SMS centre failed, see self-help.

Self-help with errors

The following table lists error situations and possible causes and provides notes on troubleshooting.



<p>You cannot send messages.</p> <ol style="list-style-type: none"> You have not requested/activated the CLIP service (Calling Line Identification Presentation). <ul style="list-style-type: none"> Ask your service provider to enable this service. SMS transfer was interrupted (e.g. by a call). <ul style="list-style-type: none"> Re-send the text message. The provider does not support this feature. No number or an invalid number is entered for the SMS service centre set as the active send centre. <ul style="list-style-type: none"> Enter the number (→ page 64).
<p>You receive an incomplete SMS.</p> <ol style="list-style-type: none"> Your phone's memory is full. <ul style="list-style-type: none"> Delete old SMS messages (→ page 60). The service provider has not yet sent the rest of the SMS.
<p>You have stopped receiving SMS messages.</p> <p>Call Forwarding is activated for All calls or Call Forwarding is activated for All calls for the network mailbox.</p> <ul style="list-style-type: none"> Change the Call Forwarding (→ page 39).
<p>The SMS is played back.</p> <ol style="list-style-type: none"> The "display call number" service is not activated. <ul style="list-style-type: none"> Ask your service provider to enable this feature (there is a charge for this). No agreement is in place between your mobile phone operator and fixed line SMS service provider. <ul style="list-style-type: none"> Obtain information from your fixed line network SMS service provider. Your terminal is recorded by your SMS provider as having no fixed line network SMS functionality, i.e. you are not registered with the provider. <ul style="list-style-type: none"> Send any SMS to automatically register your telephone to receive SMS.
<p>Messages are only received during the day.</p> <p>Your terminal is recorded in the database of your SMS provider as having no fixed line network SMS functionality, i.e. you are not registered with the provider.</p> <ul style="list-style-type: none"> Obtain information from your fixed line network SMS service provider. Send any SMS to automatically register your telephone to receive SMS.

E-mail notifications



You can set your phone to periodically connect to your incoming e-mail server and check whether you have new messages.

Prerequisites:

- ◆ You have set up an e-mail account with an ISP.
- ◆ The incoming e-mail server uses the POP3 protocol.
- ◆ The name of the incoming e-mail server and your personal access data (account name, password) are stored in the phone (→ page 125).

Your handset display will show when a new e-mail message has been received: An advisory tone sounds, the message key  flashes and the  icon is displayed in the idle display.

Notes

- ◆ The  icon is also displayed when you have new SMS messages.
- ◆ If you have also activated the authentication of the phone with the incoming e-mail server via a secure connection in the Web configurator (TLS authentication) and this fails, the e-mail messages are not downloaded to your phone.
In this case, pressing the flashing message key  will display the **Certificate error - Please check your certificates in the Web configurator.** notification.
 - ▶ Confirm message by pressing **OK**.
 - ▶ Log in to the Web configurator (→ page 110). The web page **Security** (→ page 116) tells you why the secure connection could not be established and what you can do.

Opening the incoming e-mail list

 ▶  **Messaging** ▶ **OK** ▶  **eMail**

Or, if new e-mail messages have been received (the message key  flashes):

 ▶  **eMail**

The phone establishes a connection to the incoming e-mail server. A list of e-mail messages that are stored there is displayed.

New unread messages appear above old read messages.

The following details are displayed for each e-mail: name or e-mail address of the sender (one line, abbreviated if necessary) and date and time (date and time will only display correct values if sender and recipient are located in the same time zone).

Bold: New message. E-mail messages that were not present in the incoming e-mail server when the inbox was last opened are identified as "new", regardless of whether or not they have been read.

If the incoming message list on the incoming e-mail server is empty, **No entries** will appear in the display.

Example of the display:

eMail Incoming	
Frank.Miller@mailp.com	
10/02/11	15:40
Happy Birthday	
Anna Sand	
10/02/11	10:38
Read	Delete

Note

Many e-mail providers activate spam protection measures by default. E-mail messages classified as spam are stored in a separate folder and are therefore not shown in the incoming mail list.

Some e-mail providers allow you to change this setting: ▶ Deactivate spam protection or display spam e-mails in the incoming email list.

Other e-mail providers may send a message to the inbox when a new spam e-mail is received. This is to inform you that a suspected spam e-mail has been received.

The date and sender of this mail are repeatedly updated, so that it is always displayed as a new message.

Messages when establishing a connection

The following problems may occur when connecting to the incoming e-mail server. The messages are displayed in the display for a few seconds.

Server not accessible

The connection to the incoming e-mail server could not be established. This may have the following causes:

- Incorrect entry for the name of the incoming e-mail server (→ Web configurator).
- Temporary problems with the incoming e-mail server (server is down or is not connected to the Internet).
 - ▶ Check settings in the Web configurator.
 - ▶ Try again later.

Currently not possible

The resources your phone requires to make the connection are busy, e.g.:

- The permitted number of VoIP connections has already been reached.
- One of the registered handsets is currently connected to the incoming e-mail server.
 - ▶ Try again later.

Login failed

Error when logging in to the incoming e-mail server. This may have the following cause:

- Incorrect entries for name of incoming e-mail server, user name and/or password.
 - ▶ Check settings (→ Web configurator).

Mailbox settings incomplete

Incomplete entries for name of incoming e-mail server, user name and/or password.

- ▶ Check/add to settings (→ Web configurator).

Viewing the message header and text of an e-mail

Prerequisite: You have opened the inbox (→ page 67).

▶  Select an e-mail entry. ▶ **Read.**

The subject of the e-mail (maximum 120 characters) and the first few characters of the text (maximum 560 characters) are displayed.

To return to inbox: ▶ Press the End call key .

Note

If the e-mail does not contain any standard text, the message **eMail can't be displayed** will briefly appear.

View e-mail sender's address

Prerequisite: You have opened the e-mail notification for reading (→ page 69).

Options ▶ From ▶ OK

The sender's e-mail address is displayed, over several lines if necessary (maximum 60 characters).

To return to inbox: ▶ **Back**

Deleting e-mail messages

Prerequisite: You have opened the incoming e-mail list (→ page 67) or the header or sender's address for an e-mail is displayed (→ page 69):

Options ▶ Delete ▶ OK ▶ Answer security question with Yes.

The e-mail is deleted from the incoming e-mail server.

Example:

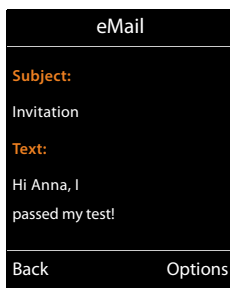

Example:

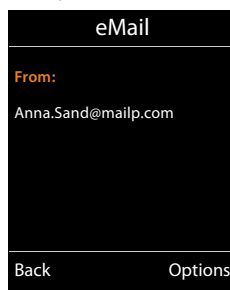

Info Centre – continuous Internet access from your phone

Data protection notice

The information services enable you to use a Gigaset telephone to call up selected information, such as weather forecasts.

The inventory data corresponds to that of the VoIP service.

When you use the service for the first time, a standard profile is created with configuration data for the device. You can then change and store the configuration data specific to your device, for example, the city for the weather forecast or the date of birth for the biorhythm. You can delete this configuration data again at any time.

The information services use the HTTP protocol.

Further information about the Gigaset.net service data saved can be found at:

www.gigaset.net/privacy-policy

You can use your phone to retrieve online content from the Internet, i.e. request info services that are provided specifically for the telephone. The info services available are constantly updated. A default selection has already been made.

Information on the gigaset.net info services is available on the Internet at:

www.gigaset.com/nextg/apps

Note

You can launch the Info Centre and display info services with every registered Gigaset C430H, E630H, C620H, S820H, SL910H or SL930H handset.

Customising info services

You can change the default setting for the Info Centre (standard profile) and add new services. Visit the Gigaset.net page www.gigaset.net on the Internet and compile your personal info services.

▶ Open the Web configurator page **Settings ▶ Info Services** (→ page 125) on the PC.

▶ Click the link gigaset.net/myaccount.

You are automatically logged in with the username and password that have been assigned to your phone by default.

Or:

▶ Enter the following address in the address field of your PC's web browser:

www.gigaset.net

▶ Enter your Gigaset.net user ID and password on the Gigaset.net page. You will find your user ID and password on the Web configurator page specified above.

In both cases, your Gigaset.net web page is displayed, where you can customise info services for your Info Centre ("Info Centre" tab) and the info services for the **Info Services** screensaver ("Screensaver" tab).

The "Info Centre" tab has an icon for every info service provided by Gigaset.net (e.g. weather, horoscope), and an icon for personal applications that you want to add to your Info Centre.

Activating/deactivating a service

An info service is displayed on your Gigaset phone if the relevant icon is orange and the option at the top right of the icon is activated.

(Example):



- 1 Icon for an activated info service (orange). The info service is displayed in the Info Centre on your Gigaset phone.
- 2 Icon for a deactivated info service (grey). The info service is not displayed on your phone.
- 3 Option to activate or deactivate the info service.

- ▶ Click the option for an icon to activate/deactivate the corresponding info service (☑ = activated).

All activated info services are provided in the display of the registered handsets when you open the Info Centre.

Customising info services

For some info services, you can customise the information that you want from your Gigaset phone yourself.

- ▶ Click the icon that belongs to an info service (e.g. weather). This will open another web page where you can customise the RSS feeds.

The web pages for the individual info services describe which settings you can make.

Example "Weather information"

- ▶ Click the icon for the weather information. This will open a web page where you can configure the weather information for your Info Centre.

The world weather is already set.

You can also set up to nine other locations (worldwide) that you can request weather information for.

- ▶ Enter the name of the location that you want to access weather information for in the editable field.
- ▶ Click on the magnifying glass icon .

This will list the locations that start with the specified name.

- ▶ Click the list icon to open the list and select the required location.
- ▶ Right-click the arrow icon  to add this location to your Info Centre.

The web page lists all the locations for which the Info Centre provides weather information.



- ▶ If a location needs to be deleted from the list, click the trash icon  next to the location name.

Info Centre – continuous Internet access from your phone

- ▶ Click the disk icon  at the top right of the web page to save your settings.

Note

You can also configure weather information on the handset itself:

- ▶ Start Info Centre: ▶  ▶ **★ Additional Features** ▶ **Info Centre**.
- ▶  Select weather information. ▶ **OK** ▶ Select the entry "Add location". ▶ **OK** ▶ Enter a location. ▶ **OK**. This will show a list of locations with the name specified. ▶ Select a city/location. ▶ **OK** ▶ Confirm selection once again with **OK**.

Starting Info Centre, selecting info services

 ▶ **★ Additional Features** ▶ **OK** ▶  **Info Centre**

Your Info Centre menu i.e. a list of available info services is displayed. You can navigate between the info services.

- ▶  Select an info service. ▶ **OK**.

To access certain info services (personalised services), you have to log in with a user name and password.

Messages when loading requested information

The information is loaded from the Internet. Wait a few seconds until the information is displayed. The display shows "Please wait...".

If the information for an info service cannot be displayed, one of the following messages appears:

Requested page can't be reached.

Possible causes:

- Time limit exceeded (timeout) when loading the information
- The Internet server for the info services cannot be accessed.
 - ▶ Check your Internet connection and repeat the request at a later date.

Coding error on requested page

The content of the requested info service is coded in a format that the handset cannot display.

Can't display requested page

General error when loading the info service.

Login failed.

Possible causes:

- You have not entered your login data correctly.
 - ▶ Reselect the info service and repeat the login process. Please remember that data is case sensitive.
- You are not entitled to access this info service.

Logging in for personalised info services

If a special login process with user name and password is required to access an info service, enter the required data:

▶ Enter **Authent. Name.** ▶ **Save** ▶ Enter **Password.** ▶ **Save**

If login was successful, the requested info service is displayed.









If login failed, a message to this effect appears on the display → Messages when loading requested information, page 72.

Note

Please remember that login data is case sensitive. For instructions on entering text
→ page 30.

Operating Info Centre

Depending on the type of info service requested, you can perform the following operations:

- ◆ To scroll within an info service: ▶  Press the control key.
- ◆ To skip back to the previous page: ▶ Press the left display key.
- ◆ To skip back to the Info Centre menu: ▶ **Briefly** press the End call key .
- ◆ To go "offline": ▶ Press and **hold** the End Call key . The handset returns to idle status.
- ◆ To enter text: ▶  Select line into which you wish to enter text. The cursor flashes in the text field. ▶ Enter the text (→ page 30). ▶ Press the right display key to complete the entry and send the data.
- ◆ To make selections: ▶  Select a line in which a selection is possible. ▶  Make a selection. ▶ Press the left display key to complete the selection and send the data.
- ◆ To set options: ▶  Select line that offers the options. The line is highlighted.
 - ▶  Activate/deactivate option (or press the left display key (e.g. **OK**)).
 - ▶ Press the left display key to complete the entry and send the data.

Hyperlink to further information:



A hyperlink to further information is displayed using the  icon.

If a page with hyperlinks is opened, the first hyperlink is highlighted.

▶  Select another hyperlink if required. ▶ Press the display key **Link** to open the associated page.

Hyperlink to a phone number:

A hyperlink to a phone number offers the **Call** function on the right display key.

- ◆ Copy an entry to the local phonebook: ▶  Select hyperlink. ▶ Press the display key .
- ◆ Dial phone number (Click-2-Call): ▶ Press the display key **Call**.

Depending on the provider, the number is dialled directly or appears first in the display. You must first confirm the number with **Yes** before it is dialled.

Accessing info services using quick dial

Each info service that is provided via Gigaset.net is assigned a quick dial that you can use to access the service. Examples:

Info service	Quick dial
News	1#92
Weather	2#92
My eBay	3#92
Encyclopaedia	4#92
Translator	5#92
Unit converter	6#92

Info service	Quick dial
Horoscope	7#92
Biorhythm	8#92
My Friends	9#92
Gigatweet	10#92
My Applications (personal info services/applications that you have defined)	99#92

- 1 The list of info services is one example. Each info service is provider-dependent.
- 2 The numbers 11 to 98 are reserved for info services/applications that are provided via Gigaset.net.

▶ Enter the quick dial for a service. ▶ Press the Talk key .

The Info Centre page with this service/application is loaded and shown on the display.

Note

If you enter the quick dial for an info service into the local phonebook and you assign this phonebook entry to a digit key on your handset (→ page 49), simply pressing and holding this digit key will show the relevant page of the Info Centre on the display.

Displaying information from the Internet as a screensaver

You can configure your handset to display one of the info services from the Info Centre (e.g. weather reports, news feeds) in the idle display of the handset.

To do this, you must switch on the **Info Services** (→ page 44) screensaver on your handset and activate the display of info services via the Web configurator (→ page 125).

The text information appears on the display approximately ten seconds after the handset returns to idle status.

Depending on the information feed selected, a display key appears on the right of the screensaver.

- ◆ To open further information: ▶ Press the right display key.
- ◆ To revert to idle status: ▶ Press and hold the End call key .





Selecting information for the screensaver

The default setting for the **Info Services** screensaver is the weather forecast. You can change this setting:

- ◆ On the PC using your account on the Gigaset.net server (→ page 70)
- ◆ On the handset using the Info Centre

 ▶  **Additional Features** ▶ **OK** ▶  **Info Centre**

The menu for your Info Centre appears.

- ▶  Select **Screensaver**. ▶ **OK** ▶  Select information service. ▶  Scroll to the next line, if necessary. ▶  Make further settings for the information service selected. ▶ **Save**.

Network mailbox

Some VoIP providers offer answer machines on the network – network mailboxes.

Each network mailbox accepts incoming calls made via the corresponding line (fixed line network or corresponding VoIP phone number). To record all calls, you should therefore set up network mailboxes for both the fixed line network and for each of your VoIP connections.

You need to have **requested** the network mailbox for your fixed line network connection from your network provider. You can store the number of the network mailbox for the fixed line network in the phone.

You can activate/deactivate the network mailboxes for your VoIP connections using the handset or the Web configurator. To do this, you only require the phone number of the network mailbox.

Activating/deactivating network mailbox, entering number

On the handset, you can manage the network mailboxes that are assigned to one of its receive connections.

 ▶  Answer Machine ▶ OK ▶  Network Mailboxes ▶ OK

The list of connections (VoIP and fixed line network) that are assigned to the handset as receive connections is displayed. **Net AM: xxx** are displayed, where xxx is replaced by the relevant default name of the connection (**Net AM: IP1** to **Net AM: IP6**, **Net AM: Fixed Line**).

If several receive connections have been assigned to the handset:

▶  Select an entry ▶ OK

VoIP connection

Status ▶  On / Off

Network Mailbox

The number that is currently stored for the network mailbox is displayed.

▶ Enter or change the phone number for the network mailbox if necessary.

With some VoIP providers your network mailbox phone number is downloaded together with the general VoIP provider data, saved to your base and displayed under **Network Mailbox**.

▶ Save

Fixed line network/connection

▶ Enter or change the phone number for the network mailbox.

▶ Save

You cannot activate/deactivate the network mailbox for the fixed line network connection via the handset. For instructions on activating/deactivating the network mailbox, see the information provided by the network provider.

Configuring a network mailbox for fast access

You can use fast access to make direct calls to a network mailbox.



Assigning key 1, changing assignment

Fast access settings are device-specific. You can assign a different network mailbox to key  on each registered handset.

No network mailbox is preconfigured for fast access in the default settings.

▶ Press and **hold** the  key.

Or:

▶  ▶  **Answer Machine** ▶ **OK** ▶  **Set Key 1**

The list of VoIP connections and the fixed line network connection assigned to the handset as receive connections is displayed. **Net AM: xxx** are displayed, where xxx is replaced by the relevant default name of the connection (**Net AM: IP1** to **Net AM: IP6**, **Net AM: Fixed Line**).

▶  Select an entry. ▶ **Select**  = activated).

If a number is already stored for this network mailbox, fast access is activated immediately.

▶ Press and **hold** the End call key  (idle status).

If no number is saved for the network mailbox, you are asked to enter the number of the network mailbox.

▶  Switch to the **Network Mailbox** line. ▶ Enter the number of the network mailbox.

▶ **Save** ▶ Press and **hold** the End call key  (idle status).

Fast access is activated.

Note

You can only assign fast access to **one** network mailbox.

You can also call the network mailboxes of the handset's receive connections directly via the message key (→ page 77).

Calling the network mailbox via fast access

▶  Press and **hold**.



If you have set a network mailbox for fast access, you are connected directly to this network mailbox.

▶  If necessary, press the handsfree key.

You will hear the network mailbox announcement.

▶  Select an answer machine. ▶ **OK**

Displaying new messages in the idle display of the handset

If a new message is present on one of the network mailboxes that is assigned to the handset via its receive connection, or on the local answer machine, the icon  and the number of new messages are displayed in idle display. The  message key flashes.

Calling the network mailbox using the message key

Under the message key  you will find a list for each network mailbox that fulfils the following prerequisites:

- ◆ The corresponding connections are assigned to the handset as receive connections
- ◆ The network mailbox phone number is saved on the phone.

You can use the list to call the network mailboxes directly and listen to the messages.

- ▶ Press the Message Key .

The following is displayed (example):

Messages & Calls	
Net AM: Fixed Line	(1)
Mailbox IP 1:	(1)
Mailbox IP 2:	
Mailbox IP 3:	
Mailbox IP 4:	
Back	OK

- 1 **Net AM: Fixed Line** is the network mailbox for the fixed line network connection
- 2 If there are new messages in the network mailbox, the list entry is shown in bold. The number of new messages is shown in brackets following the list entry.
- 3 **Mailbox IP 1;** **Mailbox IP 2;** and so on are the network mailboxes for the VoIP connections. "IP1", "IP2" and so on are the default names of the corresponding VoIP connections. The default names are always displayed regardless of which connection name you specified during configuration.
- 4 If there are no new messages, no number is shown after the list entry for the network mailbox. The number of messages stored in the network mailbox is not displayed.

Net AM: Fixed Line / Mailbox IP 1: / ... / Mailbox IP 6:

- ▶ Select the network mailbox entry ▶ **OK**

You are connected directly to the network mailbox and can hear its announcement. Messages can generally be played back using your handset keypad (digit codes). Listen to the announcement.

Notes

- ◆ The network mailbox is automatically called via the corresponding connection. An automatic area code specific to your phone is **not** prefixed.
- ◆ Network mailbox messages can generally be played back using your phone's keypad (digit codes). For VoIP, you need to define how the digit codes are to be converted to DTMF signals and transmitted (→ page 123).

Ask your VoIP provider which type of DTMF transmission it supports.

Multiple handsets

You can register up to six handsets and six Gigaset repeaters to your base.

Each registered device is assigned an internal number (1 –6) and an internal name (**INT 1 – INT 6**). You can change the number assignment and names.

If all internal numbers have already been assigned on your base, you must de-register a handset that is no longer required before registering a new one.

When you register a Gigaset handset, the base transfers entries for the following online directories to the local phonebook on the handset to enable you to use the online directories on your new handset as well.

Prerequisite: The handset can send and receive phonebook entries (see handset user guide).

- ◆ The currently set online directory (→ page 125) with a provider-specific name.
- ◆ The currently set Yellow Pages (→ page 125) with a provider-specific name.
- ◆ The private phonebook currently set with the name **Prv.NetDir**.
- ◆ The Gigaset.net phonebook with the name **Gigaset.net**.





Successful registration is acknowledged with the message **Data Transfer x entries received** for this reason.

Registering handsets

A Gigaset C530H handset can be registered to up to four bases.

Manually registering Gigaset C530H to Gigaset C530 IP

On the handset:

- ◆ The handset is not registered to a base: ▶ Press the display key **Register**.
- ◆ The handset is already registered to a base: ▶  ▶  ▶  **Registration** ▶ **OK** ▶ 
Register Handset ▶ **OK**
- ◆ The handset is already registered to four bases: ▶  Select base ▶ **OK**
- ▶ Enter the system PIN for the base if required. ▶ **OK**

The handset searches for a base that is ready for registration.

On the base station:

- ▶ Within 60 seconds, press and **hold** (approx. 3 seconds) the registration/paging key on the base (→ page 3).

Once registration is complete, the handset returns to idle status. The internal number of the handset appears in the display, e.g. **INT 1**. If not, repeat the procedure.

Note

All base connections are assigned to a handset as receive connections as soon as registration is complete.

The fixed line network connection is assigned to the handset as a send connection.

You can change the assignment → page 54.

Registering other handsets





You can register other Gigaset handsets and handsets for other devices with GAP functionality as follows:

On the handset: ▶ Start registration as described in its operating instructions.

On the base station: ▶ Press and **hold** (approx. 3 sec.) the registration/paging key on the base (→ page 3).

De-registering handsets

You can de-register any other registered handset from any registered Gigaset C530H handset.

 ▶  ▶  **Registration** ▶ **OK** ▶  **De-register Handset** ▶ **OK** ▶  Select the handset you wish to deregister. ▶ **OK** (The handset you are currently using is indicated by ◀.)

System PIN something other than 0000: ▶ Enter current system PIN. ▶ **OK** ▶ **Yes**

Locating a handset, finding the phone's IP address ("paging")

You can locate your handset using the base.

▶ **Briefly** press the Registration/paging key on the base (→ page 3).

All handsets will ring at the same time ("paging"), even if the ringtones are switched off.

The current (local) **IP address** for the base appears in the handset displays.

Ending the search

▶ **Briefly** press the Registration/paging key on the base (→ page 3).

Or: ▶ Press the Talk key  on the handset.

Or: ▶ Press the display key **Silence** on the handset.

Or: ▶ Do not press any key on the base or handset.

After approx. 30 seconds, the paging call will end **automatically**.

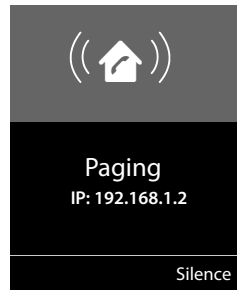

Notes

- ◆ An incoming external call will not interrupt the paging process.
- ◆ If there are already two internal connections between the handsets, then paging is not possible.
- ◆ A paging call is also signalled acoustically on handsets where the ringtone is permanently deactivated (→ page 48).

Changing the base

If your handset is registered to more than one base, you can set it to a particular base or to the base that has the best reception (**Best Base**).

 ▶  ▶  **Registration** ▶ **OK** ▶  **Select Base** ▶ **OK** ▶  Select one of the registered bases or select **Best Base**. ▶ **Select**

Multiple handsets



Making internal calls

Internal calls to other handsets registered on the same base are free.

Calling a specific handset

 Start the internal call. ▶ Enter the number of the handset.

Or:

 Start the internal call. ▶  Select the handset. ▶ Press the Talk key .

You hear the busy tone if:

- ◆ There are already two internal connections.
- ◆ The handset being called is not available (deactivated, outside range).
- ◆ The internal call is not accepted within three minutes.

Calling all handsets ("group call")

Start the internal call: ▶ Briefly press . ▶  Press the star key

Or: ▶ Briefly press . ▶ Call all ▶ Press the Talk key .

Or: ▶ Press and hold .



All handsets are called.



Ending a call

▶ Press the End call key .

Transferring a call to another handset

You can transfer (connect) an external call to another handset.

▶  Open list of handsets. The external participant hears music on hold, if activated (→ page 52). ▶  Select handset or Call all ▶ OK

◆ When the internal participant answers: ▶ Announce the external call, if necessary. ▶ 
Or before the internal participant answers: ▶ 



The external call is transferred to the other handset.

◆ If the internal participant does **not** respond or is busy: ▶ End

You return to the external call. If the internal participant does not answer or the line is busy, the call will automatically return to you.

Initiating an internal consultation/conference

When you are conducting an external call, you can call an internal participant at the same time for consultation or hold a conference call between all 3 participants.

 Open list of handsets. The external participant hears music on hold, if activated (→ page 52). ▶  Select the handset. ▶ OK. You are connected to the internal participant.

◆ Back to external call: ▶ Options ▶  End active call ▶ OK

You are reconnected with the external participant.

◆ Initiate conference call: ▶ Conference

All 3 participants are connected with each other.

If the internal participant does not answer: ▶ End. You return to the external caller.

Ending a conference call

- ▶ Press the End call key .

If an **internal** participant presses the End call key , the other handset remains connected to the external participant.

External call waiting during an internal call

If you get an **external** call while conducting an **internal** call, you will hear the call waiting tone (short tone).

Ignoring the external call

- ▶ Press the display key **Reject**.

The call waiting tone is turned off. You remain connected with the internal participant.

For calls to a VoIP connection: The external caller will hear the busy tone.

For calls to the fixed line network connection: The call continues to be signalled on the registered handsets.

Accepting an external call/putting an internal participant on hold

- ▶ Press the display key **Accept**.

Ending an internal call

- ▶ Press the End call key .

The external call is signalled as an incoming call. You can accept the call (→ page 34).

Internal call waiting during an internal/external call

If an internal participant attempts to call you while you are involved in an external or internal call, this call is shown on the display (internal call waiting). You can either accept or reject this call.

- ◆ End display: ▶ Press any key.
- ◆ Accepting an internal call: ▶ End your current call.
The internal call is signalled as per usual. You can accept the call.

Changing the name of an internal participant

The base assigns the handset a free internal number during registration (possible numbers: 1– 6). The internal number is shown on the handset display e.g. **INT 2**. You can change these names. The name must be no longer than 10 characters. The changed name is displayed in every handset's list.

 Open list of handsets. Your own handset is indicated by ◀.

- ▶  Select the handset. ▶ **Options** ▶  **Rename** ▶ **OK** ▶ Enter names.
- ▶ **Save**

Changing the internal number of an internal participant

The next unassigned internal number (1-6) is **automatically** assigned to the handset as it is registered. If all the slots are occupied, the most recently registered handset is deregistered as soon as it is in idle status. You can change the internal numbers of all registered handsets (1-6).

- ☞ Open list of handsets. Your own handset is indicated by ◀. ▶ **Options**
 - ▶ ☞ **Assign Handset No.** ▶ **OK** ▶ ☞ Select the handset, if necessary. ▶ **OK**
 - ▶ ☞ Select or enter the internal number.
 - ▶ ☞ Switch to another handset, if necessary. ▶ ☞ Select number etc.
 - ▶ **Save**

You will hear the error tone if an internal number has been assigned twice.

- ▶ Repeat the procedure with a free number.

Directories

The options are:

- ◆ (Local) phonebook
- ◆ Public online directory and Yellow Pages (→ page 86)
- ◆ Personal online directory (→ page 89)
- ◆ Gigaset.net phonebook (→ page 90)

Local handset phonebook

You can save a total of 200 entries in the phonebook.

You can create a personalised phonebook for your own individual handset. You can also send entries to other handsets (→ page 85).

Note

With the Gigaset Contacts Push app you can easily transfer your smartphone contacts to your Gigaset handset. The app can be downloaded free of charge from Google play™ or the App Store.

Phonebook entries

You can save the following information in a phonebook entry:

- ◆ First name and surname
- ◆ Up to three numbers
- ◆ Anniversary with reminder
- ◆ VIP ringtone with VIP icon.

Length of the entries



3 numbers: Max. 32 digits each

First name and surname: Max. 16 characters each

Note



You can assign numbers from the phonebook to the digit/display keys for quick access (quick dial) (→ page 49).

Opening phonebook

- ▶ Press the  key in idle status or, depending on the situation, the display key .

Directories

Creating a new entry

- ▶ Open phonebook. ▶  <New Entry> ▶ OK
- ▶ Switch between the input fields using  and enter the relevant components of the entry (names, numbers, anniversary, VIP ringtone, e-mail).
Navigate downwards to display further components.
- ▶ **Save**

To create an entry, you must enter at least one number. If you have assigned a **Caller Melody (VIP)**, the entry in the phonebook is supplemented with the icon .

Displaying/changing an entry

- ▶ Open phonebook. ▶  Select desired entry. ▶ **View**
▶ **Edit**

Or:

- ▶ Open phonebook. ▶  Select desired entry. ▶ **Options**
▶  **Edit entry** ▶ OK

Deleting an entry

- ▶ Open phonebook. ▶  Select desired entry. ▶ **Options**
▶  **Delete entry** ▶ OK

Delete **all** entries in the phonebook:

- ▶ Open phonebook. ▶ **Options** ▶  **Delete List** ▶ OK

Setting the order of the phonebook entries

You can define whether the entries are to be sorted by first name or surname.

- ▶ Open phonebook. ▶ **Options** ▶  **Sort by Surname / Sort by First Name**

If no name was entered, the default number is shown in the surname field. These entries appear at the beginning of the list, regardless of how the entries are sorted.



The sort order is as follows:

Space | Digits (0-9) | Letters (alphabetical) | Other characters.

Displaying the number of entries that are available in the phonebook

- ▶ Open phonebook. ▶ **Options** ▶  **Available Memory** ▶ OK

Selecting a phonebook entry, searching in the phonebook

- ▶ Open phonebook. ▶  Scroll to the name you are searching for.
Scroll through phonebook:  Press and **hold**

Or:

- ▶ Open phonebook. ▶ Enter the first letters (max. 8 letters). The display jumps to the first name that begins with these letters. ▶  If necessary, scroll on to the desired entry.

Example

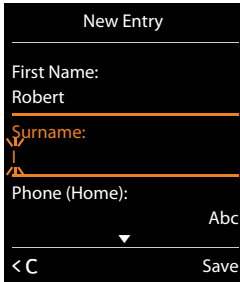

New Entry

First Name:
Robert

Surname:
▼

Phone (Home):
▼

Abc

< C Save

Transferring an entry/phonebook to another handset

Prerequisites:





- ◆ The sending and receiving handsets must both be registered to the same base.
- ◆ The other handset and the base can send and receive phonebook entries.

You can transfer the entire phonebook, an individual entry or several individual entries.

Notes

- ◆ An external call interrupts the transfer.
- ◆ Caller pictures and sounds are not transferred. Only the date is transferred for an anniversary.
- ◆ When transferring an entry between two vCard handsets:
If the recipient does not yet have an entry with that name, a new entry is created.
If there is already an entry with that name, this entry is expanded with the new numbers.
If the entry contains more numbers than allowed by the recipient, a second entry is created with the same name.
- ◆ If the recipient is not a vCard handset: A separate entry is created and sent for each number.
- ◆ Your handset receives entries from a non-vCard handset: Entries with numbers that are already stored are discarded, otherwise a new entry is created.

Transferring individual entries





- ▶ Open phonebook. ▶  Select desired entry. ▶ **Options** ▶  **Copy Entry** ▶ **OK** ▶  **to Internal** ▶ **OK** ▶  Select the recipient handset. ▶ **OK**

Phonebook entries can be sent in vCard format via SMS using **vCard via SMS**.

After a successful transfer:

- ▶ Press **Yes** if you want to send another entry. Otherwise press **No**.

Transferring the entire phonebook

- ▶ Open phonebook. ▶  Select desired entry. ▶ **Options**
▶  **Copy List** ▶ **OK** ▶  **to Internal** ▶ **OK** ▶  Select the recipient handset. ▶ **OK**

Transferring a displayed number to the phonebook

You can add numbers to the phonebook:



- ◆ From a list e.g. the call list, SMS message list or the redial list
- ◆ From the text of an SMS
- ◆ From a public online directory or the Yellow Pages
- ◆ From your private online directory
- ◆ When dialling a number

The number is displayed or highlighted.

- ▶ Press the display key  or **Options** ▶  **Copy to Directory.** ▶ **OK**

To create a new entry: ▶ **<New Entry>** ▶ **OK** ▶  Select number type. ▶ **OK**

▶ Complete the entry. ▶ **OK**

To change an entry: ▶  Select an entry. ▶ **OK** ▶  Select number type. ▶ **OK**



The number is entered or an existing number is overwritten.

▶ Answer prompt with **Yes/No.**

- ▶ **Save**

Transferring a number from the phonebook

In some operating situations, you can transfer a number from the phonebook, e.g. when sending an SMS or when dialling (even after the entering a prefix).

- ▶ Depending on the operating situation, open the phonebook using  or . ▶  Select the phonebook entry. ▶ **OK**

If more than one number is entered: ▶  Select number. ▶ **OK**

Online directories

You can use public online directories (online directories and classified directories e.g. "Yellow Pages") depending on your provider.

You can configure the net directories you wish to use via the Web configurator.

Exclusion of liability

Gigaset Communications GmbH assumes no guarantee or liability for the availability of this service. The service may be discontinued at any time.

Opening an online directory/Yellow Pages

Press and hold .

The list of online directories with the provider-specific names is displayed.

- ▶  Select the online directory from the list. ▶ **OK**

This establishes a connection to the online directory or the Yellow Pages. If there is only one online directory available, a connection is immediately established.

Note

You can also establish a connection to the online phonebook as follows:

- ▶ When the handset is idle status, dial **1#91** and press the Talk key .
- ▶ To establish a connection to the Yellow Pages, dial **2#91**.
- ▶ To establish a connection to the Gigaset.net phonebook, dial **1188#9**.

Calls to the online phonebook are always free of charge.

Searching an entry

- ▶ Enter search criteria:

Surname: (Online phonebook) or **Category/Name:** (Yellow Pages)

- ▶ Enter the name, part of a name or the category (max. 30 characters).

City: Enter the name of the city/location in which the participant you are searching for lives (max. 30 characters).

If you have already searched for the entries, the names of the cities you last entered are displayed (maximum of five).

- ▶ Enter a new name or select one of the city names displayed using . ▶ **OK**

Number: ▶ Enter the number (max. 30 characters).

- ▶ **Search** / 

You must enter details in either **Surname** or **Category/Name** and in **City** or **Number**. Searching by number is only possible if supported by the online directory you have selected. For instructions on entering text → page 30.

A list of the cities/locations found is displayed if the search returns more than one result:

- ▶  Select a city/location. ▶ **OK**. If the name of a city/location is longer than one line, it is abbreviated.

Display the full name: ▶ **View**

If no matching city/location is found: ▶ **Change** ▶ Change search criteria.

- ▶ **Search**

Directories

A corresponding message will appear on the display if no participant is found to match the search criteria. You have the following options:

- ◆ Start a new search: ▶ **New**
- ◆ Change search criteria: ▶ **Change**

No hits are displayed if the list of hits is too large. A message to this effect is displayed.

- ◆ Start a refined search (→ page 89): ▶ **Refine**

Or



- ◆ Provider dependent: Depending on the provider, you can view the list if the number of hits is also shown on the display. ▶ **View**

Search result (hit list)

The search result is shown as a list on the display. Example:

Online Dir.	1/50	1
Sand, Marie Elisabe ...		2
0049123456789		
Parkstrasse 11		
Berlin 12345, Germany		
View	Options	

1. 1/50: Consecutive number/total number of hits (only the consecutive number is displayed if the total number of hits is >99).
2. Four lines including participant's name, category, telephone number and address (possibly abbreviated). If a fixed line network number is not available, the mobile number (if available) is displayed.

- ◆ Scroll through the list: ▶ 
- ◆ Display the full entry: ▶ **View**.
This displays the full details of the entry (name, category where applicable, address, telephone numbers). You can scroll through the hit list with .
- ◆ Refine search criteria and restrict hit list: ▶ **Options** ▶ **Refine Search** (→ page 89).
- ◆ Start a new search: ▶ **Options** ▶ **New Search**
- ◆ Copy an entry to the local phonebook: ▶ **Options** ▶ **Copy to Directory**
If an entry contains several numbers, they are displayed in a selection list. A new entry is created for the selected number. The surname is transferred to the **Surname** field of the local phonebook (→ page 84).
- ◆ Transfer the selected entry to the private online directory: ▶ **Options** ▶ **Copy to Priv.NetDir**.
The private directory and online directory must be provided by the same provider. Depending on your provider, you can add a nickname to the entry in your private phonebook.

Calling participants

- ▶  Select an entry. ▶ Press the Talk key .

If the entry only contains one phone number, this is the one that is dialled.

A list of numbers appears if there is more than one number.

- ▶  Select number. ▶ **Dial**

Start a refined search

You can use the search options available in the refined search (first name and/or street) to limit the number of hits returned by a previous search.

▶ **Refine** or ▶ **Options** ▶ **Refine Search** ▶ **OK**

The search criteria from the previous search are copied and entered in the corresponding fields.

▶ Change or add search criteria, e.g. enter first name or street. ▶ **Search**

Using a private online directory

Some providers offer users the option of creating and managing a private online directory on the Internet. You can call up online directory entries from any telephone or PC, e.g. from your VoIP phone in the office or your PC at a hotel.

Prerequisites:

- ◆ Create your private online directory using your PC's web browser.
- ◆ Create and manage entries in the online directory via your PC's web browser.
- ◆ Activate the online directory on your phone using the Web configurator. You must save the username and password in particular for accessing your personal online directory on the phone.

You can use the directory from every registered handset.

Opening online directory

▶  Press and **hold**.



This opens the list of (online) directories. The provider-specific name is displayed for the private online directory.

▶  Select the private online directory from the list. ▶ **OK**

Your private online directory is opened.

Note

If there is no other online directory available apart from the private online directory:

- ▶  **Briefly** press. The private online directory is opened.
- ▶  Press and **hold**. The handset's local phonebook is opened.

The entries in the online directory are sorted alphabetically according to the first non-space field in the entry. This is generally the nickname or surname.

Selecting, viewing and managing entries in the online directory

▶  Scroll to the entry you are searching for.

Or:

▶ Enter the first letter of the name. ▶  If necessary, scroll to the entry. ▶ **View**.

The detailed view with the complete entry opens. You can scroll through the entry with the control key .

The following data is shown, if available (in the sequence specific to the provider):

Nickname, name, first name, phone number, mobile number, VoIP number, street, house number, post code, town/city, company name, business type, date of birth, e-mail.

Directories

Using other functions

▶ **Options** ▶  Select option:

Edit nickname: Edit or delete the nickname of an entry. ▶ **Save**

Copy to Directory: Copy an entry to the local phonebook (→ page 84).

Note

You can copy numbers from a public phonebook to your private online directory (→ page 88).

Calling up an entry in the online directory

▶  Select entry (open the detailed view, if necessary). ▶ Press the Talk key .

If the entry only contains one phone number, this is the one that is dialled.

If the entry contains more than one phone number (e.g. mobile number and phone number), they are offered to you for selection.

▶  Select the number to be dialled. ▶ **OK**

The selected phone number is dialled.

Transferring the local phonebook to the private online directory

You can save entries in the local phonebook in vCard format as a vcf file on your PC using the Web configurator (→ Web configurator on page 125).

Several providers support functions on your web pages that you can use to copy these files to the online directory.

Using the Gigaset.net phonebook

▶ Press and hold . The list of online directories opens. ▶  **Gigaset.net** ▶ **OK**

The Gigaset.net phonebook is opened.

Notes

- ◆ Calls to the Gigaset.net phonebook are always **free of charge**.
- ◆ You can also open the Gigaset.net phonebook by dialling **1188#9** (phone number of the Gigaset.net phonebook) and pressing the Talk key .

If no connection to the Gigaset.net phonebook can be established, an error message will be sent and the handset will switch to idle status.

Opening the Gigaset.net phonebook for the first time

When you open the Gigaset.net phonebook for the first time, you are asked to enter a nickname for your connection. You are entered into the Gigaset.net phonebook under this name.

- ▶ Press and **hold** down on the control key .
 - ▶ Select **Gigaset.net**.
- ▶ Press the display key **OK**.
- ▶ Press the display key **Options**.
- ▶ Select **Own Details**.
- ▶ Press the display key **OK**.
- ▶ Press the display key **Edit**.
- ▶ Enter the name under which you would like to be entered into the Gigaset.net phonebook (max. 25 characters).
- ▶ Press the display key **Save**.

Own Details

Your Gigaset.net

nickname:

Gi

Abc

Back
Save

Data protection notice

If you enter a nickname at this point, it is stored on a central Gigaset server. The nickname appears in the Gigaset.net phonebook, and other participants that use the Gigaset.net service can call you using this nickname.

By entering your information, you agree for this data to be saved. If you do not wish this to happen, you can cancel the operation at this point.

Cancel operation:

- ▶ Do **not** enter a name and press the display key **Save**. You can use the phonebook to search for other Gigaset.net participants and call them. However, no nickname is entered for you (your phone).

Or:

- ▶ Press and **hold** the End call key  to exit the Gigaset.net phonebook (without performing a search).

Further information about the Gigaset.net service data saved can be found at:

www.gigaset.net/privacy-policy

If an entry with this name already exists, the message **Nickname already exists. Please change.** is displayed. You are prompted to enter a name again.

Searching for participants on Gigaset.net

Once the connection to the Gigaset.net phonebook has been established, you are asked to enter a name that you want to search for.

- Gigaset.net name:** ▶ Enter the name or part of a name (max. 25 characters). ▶ **Search**

Directories

If the search has been successful, a hit list is displayed containing all the names that begin with the specified character string.

▶ Scroll through the hit list with .

If **no matching** entry is found, a corresponding message is displayed. You have the following options:

- ◆ Start a new search: ▶ **New**.
- ◆ Change search criteria: ▶ **Change**



The name you previously entered in the search field is used as the search criterion. You can then expand or edit as required.

If there are **too many matching** entries in the Gigaset.net phonebook, the message **Too many entries found** is displayed instead of a hit list.

- ◆ Start a refined search: ▶ **Refine**

The previously entered name is copied and you can edit/expand it.

Calling participants

▶  Select the participant from the hit list. ▶ Press the Talk key .

Viewing the participant's number

▶  Select the participant from the hit list. ▶ **View**

The display shows the Gigaset.net number and the participant's name. The name may appear over a number of lines.

▶  Display the name and number of the next/previous participant in the hit list.

Notes

- ◆ Connections to Gigaset.net are always established via the Internet. This is regardless of the send connection configured/selected on your handset.
- ◆ You can open the Gigaset.net phonebook and establish connections, even if you have not entered yourself in the Gigaset.net phonebook.

Using other functions

Prerequisite: The hit list is displayed.

▶  Select entry ▶ **Options** ▶  Choose option:

Copy to Directory: Copy the number to the phonebook of the handset. The number and name (abbreviated if necessary, max. 16 characters) are copied to the local phonebook.

▶ Edit and save the entry where necessary (→ page 84).

The hit list is displayed again.

New Search: Start a search with a new name (→ page 91).

Refine Search: Start a refined search. The name previously searched for is copied and you can edit/expand it.

Own Details: See "Entering, editing and deleting your own entry".

Example:

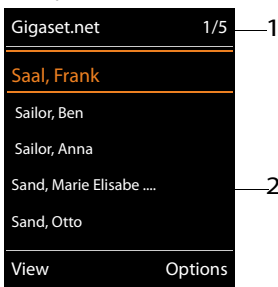

1. 1/5: Entry number/number of hits
2. Name of an entry, possibly abbreviated

Note

If you select a Gigaset.net number from the local phonebook, the connection is automatically established via Gigaset.net (Internet).

Entering, editing and deleting your own entry**Viewing your own entry**

You are connected to the Gigaset.net phonebook and have performed a search. A hit list is displayed:

▶ **Options** ▶ **Own Details** ▶ **OK**

Your Gigaset.net number and, where applicable, your current name are displayed.

Entering/editing a name

▶ **Change** ▶ Edit name or enter a new name (max. 25 characters). ▶ **OK**.

You can delete the name with **<C**.

If there is no existing entry with this name in the Gigaset.net phonebook, the name is saved. A message to this effect is displayed. The handset switches to idle status.

If there is already an entry with this name, or the entered name contains impermissible characters, you are requested to enter a different name.



If an entry has been created successfully in the Gigaset.net phonebook, the message "**Saved**" is displayed.

Notes

- ◆ Please note the data protection notice when saving a name, → page 91.
- ◆ If you delete the name, your entry is deleted from the phonebook. You are no longer "visible" to other Gigaset.net participants. However, you can still be reached via your Gigaset.net number. For instructions on displaying the number, → page 138.
- ◆ You can also enter/edit your Gigaset.net name via the Web configurator.

Calling a Gigaset.net participant

You can call a Gigaset.net participant directly via the Gigaset.net phonebook (see above) or via their Gigaset.net number:

- ▶ Enter the Gigaset.net number (including the #9) or  select it from the local phonebook.
- ▶ Press the Talk key .

Every number ending with #9 is dialled via Gigaset.net.

Call lists

Prerequisite: Calling Line Identification (CLIP, → page 35)

Your base stores calls in various lists:

- ◆ Accepted calls (max. 30 entries)
- ◆ Outgoing calls (max. 60 entries)
- ◆ Missed calls (max. 30 entries)

Opening the lists:

- ◆ Via the display key: ▶ **Calls**
- ◆ Via the menu: ▶  ▶  ▶ **OK** ▶  Select list. ▶ **OK**
- ◆ Missed calls list: ▶ Message key  ▶  **Missed Calls:** ▶ **OK**

Viewing an entry:

- ▶  Select an entry. ▶ **View**. All available information is displayed, e.g. the corresponding number when a name is displayed.

Calling back a caller:

- ▶  Select an entry. ▶ Press the Talk key .

Deleting an entry/list:

- ▶ **Options** ▶  **Delete entry** or **Delete all**.

Copying a number to the phonebook:







- ▶ **Options** ▶  **Copy to Directory** (→ page 86).

Note



You can receive information on unknown numbers free of charge via the reverse search in the online directory (→ page 87).

List entry

The following information is displayed in the list entries:

- ◆ The list type (in the header row)
- ◆ Icon for the type of entry:
 -  (Missed calls),  (Accepted calls),  (Outgoing calls)
- ◆ Caller's number. If the number is stored in the phonebook, name and number type ( Phone (Home),  Phone (Office),  Phone (Mobile)) are displayed instead. For missed calls, the number of missed calls from this number is also shown in square brackets.
- ◆ Name of the connection to which the missed/accepted call was directed (**for** receive connection), or via which the outgoing call was dialled (**via** send connection). The connection name you have assigned is displayed where available. Otherwise, the standard name is used.
- ◆ Date and time of call (if set)

Example of list entries:



All calls	
  Frank	
for IP2	
Thursday 14/02/2011, 15:40	
 089563795	
for IP1	
Thursday 13/02/2011, 15:32	
View	Options

Note

Multiple calls from the same number are stored once in the missed calls list (the latest call). The number of calls from this number is shown in brackets after the entry.

One Withheld entry is created for all missed calls for which the number of the caller was withheld.

Equally, **one** entry **Unavailable** is created for every call for which the number was not transferred.

- ▶ Call back the selected caller: ▶ Press the Talk key .
- ▶ Additional information: ▶ Press the display key **View**.
- ▶ **Options** ▶  Select option:
 - Copy to Directory:** Copy number to the phonebook.
 - Delete entry:** Delete the selected entry.
 - Delete List:** Delete all entries.

When you exit the call lists, all entries are set to the status "old", i.e. the next time you call up the list, they will no longer be shown in bold.

Note

In the case of each handset, only those accepted/missed calls directed to its receive connections are shown.

ECO DECT uses less energy and reduced transmission power.

Reducing transmission power (radiation)

In normal operation (default setting):

The device range is set to maximum as default. This guarantees optimum wireless management. In idle status, the handset will not function (as it is not transmitting). Only the base will maintain contact with the handset via a low wireless signal. During a call, the transmission power automatically adapts to the distance between the base and handset. A closer distance to the base means lower transmission power.

You can reduce the transmission power even further:

1) Reducing the range and thereby lowering transmission power by up to 80%

In many spaces such as apartments, business facilities and offices, the maximum range is not necessary. If you deactivate the **Maximum Range** setting, you can reduce the transmission power during a call by up to 80%, using half of the range.

 ▶  ▶ OK ▶  ECO DECT ▶ OK ▶  Maximum Range ▶ Change = activated)

Display icon for reduced range → page 103.

This setting cannot be used with a repeater (→ page 58).

2) Deactivating DECT wireless module in idle status (Eco Mode+)

With the **No Radiation** setting, you can deactivate the transmission power of the base completely in idle status.

 ▶  ▶ OK ▶  ECO DECT ▶ OK ▶  No Radiation ▶ Change = activated)

When the wireless mode is deactivated, the icon  is displayed in idle display instead of the signal strength icon.

This setting cannot be used with a repeater (→ page 58).

Notes

- ◆ To enjoy the benefits of the **No Radiation** setting, all registered handsets must support this feature.
- ◆ When the **No Radiation** setting is activated and a handset is registered to the base that does not support this feature, **No Radiation** will automatically be deactivated. As soon as this handset is deregistered, **No Radiation** will automatically be re-activated.
- ◆ The wireless connection will only be established for an incoming or outgoing call and the connection will be delayed by about 2 seconds.
- ◆ So that a handset can establish a wireless connection with the base more quickly for an incoming call, it must "listen" to the base more often, i.e. scan the environment. This increases power usage and reduces the standby and talktime duration of the handset.
- ◆ When **No Radiation** is activated, there will be no range display/range alarm on the handset. Contactability can be tested by assigning a line: Press and hold the Talk key . You will hear the ringing tone.

Alarm clock

Prerequisite: Date and time are set.

Activating/deactivating the alarm clock and setting the wake-up time

 ▶  ▶ OK ▶  Alarm Clock ▶ OK

Activation: ▶  On / Off

Time: ▶ Enter the wake-up time in 4-digit format.

Occurrence: ▶ **Monday-Friday / Daily**

Volume: ▶  Set the volume.

Melodie: ▶  Select melody.

▶ **Save**

The  icon and wake up time are shown in idle display.

A wake-up call is shown on the display (→ page 104) and signalled with the selected ringtone melody. The wake-up call sounds for 60 seconds. If no key is pressed, the wake-up call is repeated twice at five minute intervals and then switched off.

During a call, the alarm is only indicated by a short tone.

Deactivating the wake-up call/repeating after a pause (snooze mode)

Deactivate the wake-up call: ▶ Press the display key **OFF**.

Repeat the wake-up call: ▶ Press the display key **Snooze** or any key.

The wake-up call is deactivated and then repeated after 5 minutes. After the second repetition the wake-up call is deactivated completely.

Calendar

You can remind yourself of up to **30 appointments**.

In the calendar, the current day is outlined in white; on days with appointments, the numbers are displayed in colour. When a day is selected, it will be highlighted.

You can create the calendar display using a display key in idle status (→ page 50).

Saving appointments to the calendar

Prerequisite: Date and time are set (→ page 51).

 ▶  ▶ OK ▶  Calendar ▶ OK

▶  Select the desired day. ▶ OK

◆ Appointments that have already been stored are shown.

Enter further appointments: ▶ <New Entry> ▶ OK.



Calendar

- ◆ If no appointments have been entered, the data input window will open immediately to add the new appointment.

Activation: ▶  On / Off

Date: The selected day is preset. ▶ Enter new data to change.

Time: ▶ Enter time (hour and minute) of the appointment.

Text: ▶ Appointment name (e.g. dinner, meeting).

Signal: ▶  Select the melody of the reminder signal or deactivate the acoustic signalling.

▶ Save

Signalling of appointments/anniversaries

Anniversaries are transferred from the phonebook and displayed as an appointment. An appointment/anniversary is displayed in idle status and signalled for 60 seconds with the selected ringtone.

You can deactivate the reminder call or respond with an SMS:

▶ Acknowledge and end the reminder call: ▶ Press the display key **OFF**.

Or:

▶ Open SMS menu: ▶ Press the display key **SMS**.

When you are on the phone, a reminder call is indicated on the handset with a **single** advisory tone.

Displaying missed appointments/anniversaries

The following appointments and anniversaries are stored in the **Missed Alarms** list:

- ◆ The appointment/anniversary call was not acknowledged.
- ◆ The appointment/anniversary was signalled during a phone call.
- ◆ The handset was switched off at the time of the appointment/anniversary.

The last 10 entries are stored. The  icon and the number of new entries are shown in the display. The most recent entry appears at the top of the list.

Opening the list

▶ Message Key  ▶  **Missed Alarms** ▶ OK





Or:

▶ Using the menu:  ▶  ▶ OK ▶  **Missed Alarms** ▶ OK
▶  Scroll in the list if required

Each entry is displayed with the number or name, date and time. The most recent entry appears at the top of the list.

- ◆ To delete an appointment/anniversary: ▶ **Delete**
- ◆ To write an SMS: ▶ **SMS** (only if you have opened the list using the menu)

Displaying/changing/deleting saved appointments

 ▶  ▶ OK ▶  Calendar ▶ OK ▶  Select the desired day. ▶ OK

The appointment list is displayed. ▶  Select the desired appointment.

- ◆ To display appointment details: ▶ **View**. The appointment settings are displayed.
- ◆ To change appointment: ▶ **View** ▶ **Edit**
- Or: ▶ **Options** ▶ **Edit entry** ▶ **OK**
- ◆ To activate/deactivate an appointment: ▶ **Options** ▶ **Activate/Deactivate** ▶ **OK**
- ◆ To delete an appointment: ▶ **Options** ▶ **Delete entry** ▶ **OK**
- ◆ To delete all appointments for a day: ▶ **Options** ▶ **Delete all Appoints.** ▶ **OK** ▶ **Yes**

Baby monitor

When the baby monitor is switched on, the stored (internal or external) destination number is called as soon as a defined noise level is exceeded in the vicinity of the handset. The baby monitor alarm to an external number is cancelled after approximately 90 seconds.

In baby monitor mode, incoming calls are only signalled on the display (**without ringtone**). The display backlight is reduced to 50%. Advisory tones are deactivated. All keys are locked, with the exception of the display keys and pressing the centre of the control key.

You can answer the baby monitor alarm using the **Two Way Talk** function. Deactivate/activate the speaker of the handset with this function.

If you accept an incoming call, the baby monitor mode is suspended for the duration of the call, but the function **remains** activated. The baby monitor mode is not deactivated by switching the handset off and on again.

Caution

Ensure the following points:

- ◆ The handset should be positioned 1 to 2 metres away from the baby. The microphone must be pointed towards the baby.
- ◆ Activating the function reduces the operating time of your handset. If necessary, place the handset in the charging cradle.
- ◆ The baby monitor is activated 20 seconds after switching on.

Please always check the functionality when you switch on the function:

- ◆ Test the sensitivity.
- ◆ Check the connection if you are forwarding the baby monitor alarm to an external number.
- ◆ Make sure that an answer machine is deactivated at the target number.

Activating the baby monitor function and entering the 'call to' number

 ▶  **Additional Features** ▶ **OK** ▶  **Baby Monitor** ▶ **OK**

Activation: ▶  **On / Off**

Send alarm to: ▶  **Internal / External**

External: ▶ Enter the number or select from the phonebook (press the display key ).

Internal: ▶ **Change** ▶ Select handset or **Call all** to call all registered handsets ▶ **OK**.

In idle display, the destination number or the internal destination number is displayed.

Two Way Talk: ▶  **On / Off**. Deactivate/activate the handset's speaker

Sensitivity: ▶  **Low / High**. Select the sensitivity for the noise level.

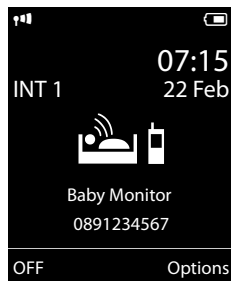

▶ **Save**

Cancelling/deactivating the baby monitor alarm



Ending call **when the baby monitor alarm is activated:** ▶ Press the End call key .

Deactivate baby monitor alarm mode: ▶ **In idle status** press the display key **OFF**.

Deactivating the baby monitor alarm remotely

Prerequisites:

- ◆ The telephone must support tone dialling
- ◆ The baby monitor alarm is forwarded to an external destination number.
- ◆ If baby monitor alarm is activated via a VoIP connection, the DTMF signalling must be done via SIP info or RFC2833 (→ page 123).

▶ Accept the baby monitor alarm call. ▶ Press keys  .

The call is ended. The baby monitor is deactivated and the handset is in idle status. The baby monitor alarm settings on the handset (e.g. no ringtone) will, however, remain activated until you press the display key **OFF** on the handset.

Reactivate baby monitor alarm with the same number:

▶ Re-activate. ▶ **Save**

Operating the telephone on a PABX

The following settings are only necessary if your PABX requires them; see the PABX user guide.

Note

You cannot send or receive SMS messages on PABXs that do not support Calling Line Identification.

Dialling modes and flash time

Changing the dialling mode



You can choose between tone dialling (**Tone**) and pulse dialling (**Pulse**).

 ▶  ▶ **OK** ▶  **Telephony** ▶ **OK** ▶  **Dialling Mode** ▶ **OK**
▶  Select dialling mode ▶ **Select** (● = selected).

Regardless of the setting, the phone automatically switches to tone dialling (DTMF) after dialling or during a call, e.g. for controlling an answer machine remotely.





Setting flash time (fixed line network)

By default, your phone is set for operation on the main connection (flash time 250 ms). For operation on a PABX, you may have to change this value. Please refer to the user guide of your PABX.

 ▶  ▶ **OK** ▶ **Telephony** ▶ **OK** ▶ **Recall** ▶  Select flash time ▶ **Select** (● = selected).
Possible values: 80 ms, 100 ms, 120 ms, 180 ms, 250 ms, 300 ms, 400 ms, 600 ms, 800 ms.

Saving an access code (outside line code)

If you must enter an access code in front of the phone number for external calls using your PABX (e.g. "0"), you can enter an access code for dialling via the fixed line network and for dialling via VoIP.

 ▶  ▶ **OK** ▶  **Telephony** ▶ **OK** ▶  **Access Code** ▶ **OK**

Fixed line network: **Access external line with:** ▶ Enter or change access code, max. 3 digits.

VoIP: **Access external line with:** ▶ Enter or change access code, max. 4 digits.

▶ For:

 **Call Lists:** The access code is prefixed only to numbers dialled from one of the following lists: SMS list, accepted calls list, missed calls list.

 **All calls:** The access code is prefixed to all numbers dialled.







 **Off:** The access code for the fixed line network is deactivated. It is not prefixed to any phone number.

▶ Save

Note



The access code never prefixes any emergency numbers and SMS service centre numbers.

Setting pauses (fixed line network)

 ▶ *  #  0  5  #  ▶ Enter one of the following function-specific codes:

◆ Pause after line seizure

  MNO ▶  ▶ OK (for 1 sec.)

  MNO ▶  ABC ▶ OK (for 3 sec.)

  MNO ▶  DEF ▶ OK (for 7 sec.)

◆ Pause after Recall key



  ABC ▶  ▶ OK (for 800 ms.)

  ABC ▶  ABC ▶ OK (for 1600 ms.)



  ABC ▶  DEF ▶ OK (for 3200 ms.)

◆ Dialling pause (Pause after access code)

  ▶  ▶ OK (for 1 sec.)

  ▶  ABC ▶ OK (for 2 sec.)

  ▶  DEF ▶ OK (for 3 sec.)

  ▶  GHI ▶ OK (for 6 sec.)

Enter a dialling pause when dialling:

▶ Press R key  for around 2 seconds. An R appears in the display.

Switching temporarily to tone dialling (DTMF)

If your PABX still operates with pulse dialling (PD), but you need tone dialling for a connection (e.g. to listen to the network mailbox), you must switch to tone dialling for the call.

Prerequisite: You are conducting a call or have already dialled an external number.

▶ Press the star key  briefly.

Or:

▶ **Options ▶ Tone Dialling ▶ OK**

After the call ends, pulse dialling is automatically reactivated.

Display icons

Icons in the status bar

The following icons are displayed in the status bar depending on the settings and the operating status of your telephone:

Icon	Meaning
	Signal strength (No Radiation off)
	76% - 100%
	51% - 75%
	26% - 50%
	1% - 25%
	Red: no connection to the base
	No Radiation activated: white, if Maximum Range is on; green, if Maximum Range is off
	Ringtone deactivated
	"Beep" ringtone activated
	Key lock

Icon	Meaning
	Battery charge status:
	White: charged over 66%
	White: charged between 34% and 66%
	White: charged between 11% and 33%
	Red: charged below 11%
	Flashes red: battery almost empty (approx. 5 minutes talktime remaining)
	Battery is charging (current charge status):
	0% - 10%
	11% - 33%
	34% - 66%
	67% - 100%

Message display

New messages:

	On the network mailbox (→ page 94)
	In the missed calls list (→ page 94)
	In the SMS list (→ page 61), the e-mail list (→ page 67)
	In the missed appointments list (→ page 98)



Menu icons



	Messaging
	Call Lists
	Select Services
	Additional Features
	Settings

Display icons

Display key icons

The following icons indicate the current function of the display keys according to the operating situation:

Icon	Action
	Last number redial
	Delete text

Icon	Action
	Open phonebook
	Copy number to the phonebook

Display icons for signalling of



Establishing a call
(outgoing call)



Connection
established



No connection
established/connection
terminated



External call



Internal call



Reminder call for
anniversary



Reminder call for
appointment



Alarm call

Other display icons



Information



(Security) prompt



Please wait...



Action complete
(green)



Action failed (red)

Menu overview

Open main menu: ▶ With the handset in **idle status** press :

✉ Messaging

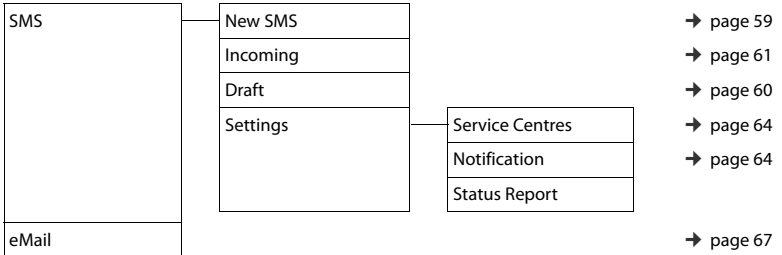

📞 Call Lists

📞 Answer Machine

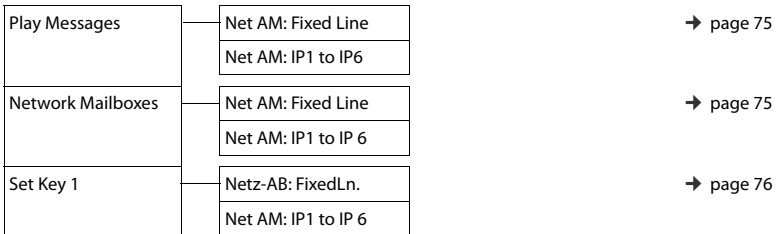

📞 Select Services

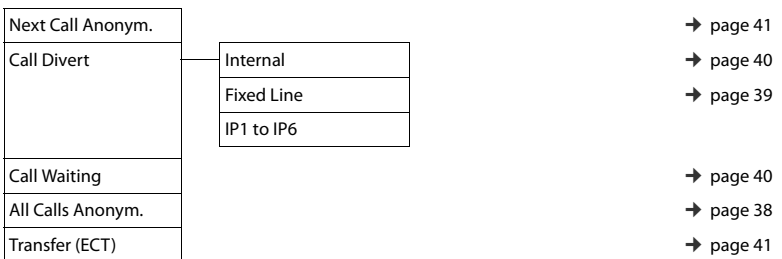

Menu overview

★ Additional Features

Info Centre	→ page 70
Calendar	→ page 97
Alarm Clock	→ page 97
Baby Monitor	→ page 99
One Touch Call	→ page 33
Missed Alarms	→ page 98

⚙ Settings

Date/Time	→ page 51		
Audio Settings	Handset Volume	→ page 46	
	Earpiece Profiles		
	Advisory Tones	→ page 48	
	Ringtones (Handset)	Volume	→ page 46
		Melodies	→ page 47
		Time Control	→ page 47
	Anon. Calls Silent	→ page 47	
	Music on hold	→ page 52	
Display	Screensaver	→ page 44	
	Info Ticker	→ page 45	
	Colour Schemes	→ page 45	
	Backlight	→ page 45	
Language	→ page 44		
Registration	Register Handset	→ page 78	
	De-register Handset	→ page 79	
	Select Base	→ page 79	

Telephony	Auto Answer		→ page 45	
	Area Codes		→ page 52	
	VoIP Wizard		→ page 53	
	Send Connections	INT 1 ... INT 6	→ page 54	
	Rec. Connections	INT 1 ... INT 6	→ page 55	
	Dialling Mode	Tone		→ page 101
		Pulse		
	Recall			
Access Code			→ page 101	
System	Reset Handset		→ page 57	
	Handset PIN			
	Base Reset		→ page 57	
	Base Restart		→ page 56	
	Repeater Mode		→ page 58	
	Local Network		→ page 52	
	Update Firmware		→ page 55	
	System PIN		→ page 51	
Eco Mode	Eco Mode		→ page 96	
	Eco Mode+		→ page 96	

Configuring the phone via the Web configurator

The Web configurator for your Gigaset telephone enables you to change the settings for your phone conveniently on your PC.

- ◆ You can make settings that are also possible using your telephone handset using the web browser on your PC as an alternative, e.g. configure VoIP connections, download firmware updates or start Eco Mode.
- ◆ You can make additional settings that are not possible via the handset, e.g. meet particular prerequisites for connecting the phone to a company network or adjust the voice quality on VoIP connections.
- ◆ On the base, you can save data that is required to access specific services on the Internet. These services include access to public and private online directories, to the incoming e-mail server for your e-mail account and synchronising date/time with a time server.
- ◆ You can save data for your phone (base and handsets) in files on the PC and, in the event of an error, you can download them onto your phone again.

Below you will find a list of the Web configurator functions and the navigation paths to the Web configurator pages where the functions are available. See the online help for the Web configurator for a detailed description of the web pages and the required entries (→ page 114).

Connecting the PC with the telephone's Web configurator

Prerequisites:

- ◆ A standard web browser is installed on the PC, e.g. Internet Explorer version 7.0 or higher, Firefox version 3.5 or higher or Apple Safari version 3.x.
- ◆ The phone and PC are directly connected with each other via a router. The settings of any existing firewall installed on your PC allow the PC and phone to communicate with each other.

There are two ways of connecting your PC to the phone's Web configurator:

- ◆ Via the phone's IP address in the local network
- ◆ Via the Gigaset configuration service, if the phone and PC are connected to the Internet (→ page 109).

Notes

- ◆ Depending on your VoIP provider, it is possible that you will be unable to change individual settings in the Web configurator.
- ◆ The phone is **not** blocked while you select your settings in the Web configurator. You can make calls with your phone or modify settings at the same time.
- ◆ While you are connected to the Web configurator, it is blocked to other users. It cannot be accessed by more than one user at any one time.

Establishing a connection via the phone's IP address

- ▶ Establish the telephone's current IP address on the handset:
You can see the phone's current IP address in the handset display by **briefly** pressing the registration/paging key on the base.
Your phone's IP address can change if you have activated dynamic IP address assignment (→ page 52).

Caution

If one of the four parts of the IP address contains leading zeros (e.g. 002), these zeros must not be entered in the web browser's address field. Otherwise, the web browser will not be able to establish a connection to the Web configurator.

Example: The IP address 192.168.002.002 is displayed on the phone. 192.168.2.2 should be entered in the address field.

- ▶ Open the web browser on your PC.
- ▶ Enter **http://** and the phone's current IP address (for example: <http://192.168.2.2>) into the web browser's address field.
- ▶ Press the return key.

A connection is established to the phone's Web configurator.

Establishing a connection via Gigaset config

Prerequisite: PC and telephone are connected to the Internet.

- ▶ Open the web browser on your PC.
- ▶ Enter the following URL into the web browser's address field:
<http://www.gigaset-config.com>
- ▶ Press the return key.

You will receive a message stating that the connection has been forwarded to your phone.

If several Gigaset phones can be reached via your Internet connection, you are asked which of these phones you would like to be connected to.

After successfully forwarding the connection, the Web configurator's **Login** page is displayed in the web browser.

Note

The connection between the PC and the Web configurator is a local connection (LAN connection). The Internet is only accessed to establish the connection.

Logging in to/off the Web configurator

Prerequisite: PC and telephone are connected to the Internet.

Logging in, setting the interface language

Once you have successfully established the connection, the website **Login** is displayed in the web browser.

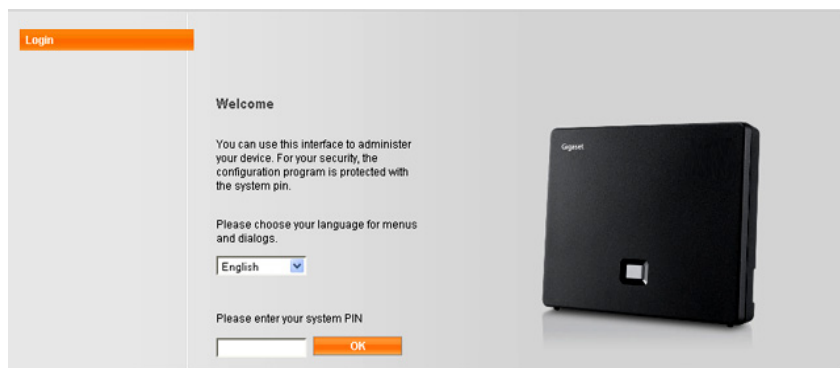

Figure 1 Start screen

You can select the language you want the menus and Web configurator dialogs to be displayed in. The language that is currently selected is displayed in the first field on the web page.

- ▶ If necessary, click to open the list of available languages.
- ▶ Select the language.

The web page is reloaded in the selected language. This may take some time, as the web pages for the Web configurator for the required language are loaded onto the base from the configuration server.

- ▶ Enter your telephone's system PIN in the bottom field of the web page (default setting: 0000) to access the Web configurator functions.
- ▶ Click **OK**.

Once you have successfully logged in, the **Home** web page opens with general information on the Web configurator.

If you enter an incorrect system PIN, a corresponding message is displayed. You are prompted to re-enter the PIN.

If you enter an incorrect system PIN a second time, the PIN field is blocked for a short time (greyed out). The duration of the block will double each time a PIN is subsequently entered incorrectly.

Notes

- ◆ If the system PIN is still set as 0000 on the phone (default setting), you will be notified during login that the device is not secure and you should change the PIN. You can deactivate this security advice for subsequent logins by selecting the option "**Don't show this security advice again.**". Click **OK** to close the dialog box.
- ◆ If you do not make any entries for a lengthy period (around 10 minutes), you will be automatically logged off. The next time you try to make an entry or open a web page, the **Login** web page is displayed. Re-enter the system PIN to log back in again.
- ◆ Any entries that you did not save on the phone before automatic logoff will be lost.

Logging off

In the menu bar (→ page 112) at the top right of every web page in the Web configurator, you will see the command **Log Off**. Click **Log Off** to log off from the Web configurator.

Caution

Always use the **Log Off** command to end the connection to the Web configurator. If, for example, you close the web browser without logging off beforehand, access to the Web configurator may be blocked for a few minutes.

Understanding the structure of the Web configurator pages

The Web configurator pages (web pages) contain the UI elements shown in Figure 2 (example).

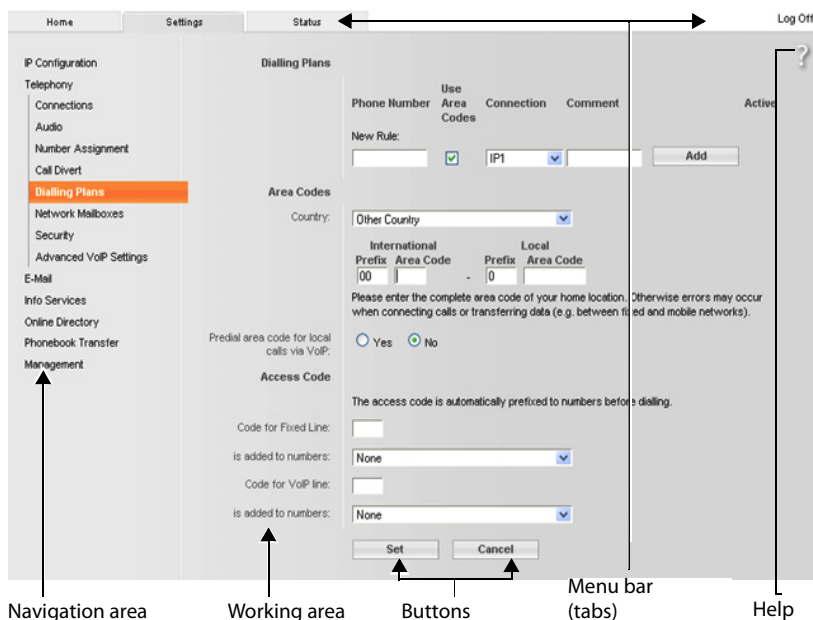

Figure 2 Example of the structure of a Web configurator page

Menu bar

The Web configurator menus are displayed in the form of tab pages in the menu bar.

The following menus are available:

Home

The home page opens once you have logged in to the Web configurator. It contains information on the Web configurator functions.

Settings

This menu allows you to make settings on your phone.

If you click on the **Settings** menu, a list with the functions of this menu is displayed in the navigation area (→ page 113).

Status

This menu provides you with information about your phone.

Log Off

You will find the **Log Off** function to the right of the menu bar on every web page.

Note

For an overview of the Web configurator menus, see → page 115.

Navigation area

The functions of the menu selected in the menu bar (→ page 112) are listed in the navigation area.

If you select a function, the associated page containing information and/or input fields is opened in the working area. The selected function is highlighted in orange.

If a function is assigned subfunctions, these are listed below the function as soon as you select the function (in the example **Telephony**).

The relevant page for the first subfunction (highlighted in orange) is displayed in the working area.

Working area

Depending on the function selected in the navigation area, information or dialog boxes are displayed in the working area that allow you to make or change your phone settings.

Making changes

Make settings for entry fields, lists or options.

- ◆ There may be restrictions regarding the possible values for a field e.g. the maximum number of characters, entering special characters or certain value ranges.
- ◆ To open a list, click the button. You can choose between default values.
- ◆ There are two kinds of options:
 - Checkboxes: You can select one or more options from a list. Active options are indicated by , non-active options by . You can activate an option by clicking . The status of the other options in the list does not change. You can deactivate an option by clicking .
 - Alternative options (radio buttons). The active option in the list is indicated by , and the non-active by . You can activate an option by clicking . The previously activated option is deactivated. You can only deactivate an option by activating another option.

Applying changes

As soon as you have made your change on a page, save and activate the new setting on the phone by selecting **Set**.

If your entry does not comply with the rules for this field, an appropriate error message is displayed. You can then repeat the input.

Caution

Changes that have not been saved on your phone are lost if you move to another web page or the connection to the Web configurator is lost, e.g. due to exceeding the time limit (→ page 111).

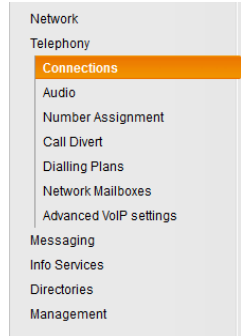

Configuring the phone via the Web configurator

Buttons

Buttons are displayed in the bottom section of the working area. Depending on the current function of a web page, various buttons are displayed. The functions of these buttons are described in the online Help of the Web configurator. The most important buttons are:

Cancel

Reject changes made on the web page and reload the settings that are currently saved in your phone to the web page.

Set

Store changes made on a web page on the phone.

Help

You will see a question mark at the top right of most web pages. Click this question mark to open the online help for this web page in a separate window.

The help pages are downloaded directly from the configuration server.

Note

You may need to change your browser settings to display the help pages correctly. Internet Explorer and Firefox require the following settings, for example:

- ▶ You must allow blocked active content for help (right-click the information bar at the top of the browser window).
- ▶ Allow the pages to use their own fonts or set Arial as the standard font (general option).

Means of representation in online help

Bold font

User interface terms such as menu functions, names of input fields and options.

[Bold font]

Buttons.

[About this Help▶](#) / [About this Help▼](#)

Blue, underlined text shows hidden text.

Click this link once to show the hidden text. The arrow at the end of the link rotates by 90°.

Click [About this Help▼](#) to hide the text again.

Telephony > Dialling Plans

Navigation to a Web configurator function.

Matches the illustration "Telephony ▶ Dialling Plans" in this user guide (▶ Opening web pages below)

Searching in help

Click inside the Help window and press the **Ctrl** and **F** keys. A search dialog is opened.

Opening web pages

A brief outline of how to navigate to the individual Web configurator functions is given below.

Example

Defining dialling plans:

Settings ▶ Telephony ▶ Dialling Plans

To open the web page, proceed as follows after login:

- ▶ Select the **Settings** menu in the menu bar.
- ▶ Click on the **Telephony** function in the navigation area.
The **Telephony** subfunctions are displayed in the navigation tree.
- ▶ Select the **Dialling Plans** subfunction.

Web configurator menu



Functions of the Web configurator

Connecting the base to the local network (LAN/router)

You can find the functions for connecting to the LAN on the web page:

Settings ▶ IP Configuration

In most cases, special settings are not required to connect the phone to the router/a local network. Your phone is preconfigured for dynamic assignment of the IP address by default (DHCP). In order for your router to "recognise" the phone, dynamic IP address assignment must also be activated on the router, i.e. the router's DHCP server must be activated.

If the DHCP server cannot or should not be activated, you must assign a fixed/static IP address to the phone (→ page 52). A fixed IP address is useful, for example, if port forwarding or a DMZ is set up on the router for the phone.

You can also assign a static IP address via the handset.

You can also use the Web configurator to make further settings that are required if you connect your phone to a large (company-wide or organisation-wide) network, or if you want to manage the phone remotely using the Web configurator. You can:

- ◆ Specify the address of a HTTP proxy server within the LAN that the phone can use to establish connections to the Internet if direct access is not allowed in the LAN.
- ◆ Store **VLAN Identifier / VLAN Priority** for access to a tagged VLAN.
- ◆ Allow PCs outside your LAN to connect to the Web configurator.

Caution

- ◆ Authorising access from other networks increases the risk of unauthorised access. It is therefore recommended that you disable remote access if you no longer require it.
- ◆ The Web configurator can only be accessed from other networks if your router passes on the service requests from "outside" to port 80 (the default port) of the phone. Make sure you read the user guide for your router.

Making security settings – managing certificates for TLS authentication

The phone supports the establishment of secure data connections on the Internet with the TLS security protocol (Transport Layer Security). With TLS, the client (the phone) uses certificates to identify the server. These certificates must be stored on the base.

You can manage TLS certificates using the web page:

Settings ▶ Network ▶ Security

On this page you will find the **Server Certificates / CA Certificates** lists. They contain the certificates saved in the base. The certificates have either already been saved on the base by default, or you have downloaded them to your base via the **Security** web page.

The **Invalid Certificates** list contains the certificates received from servers that have not passed the certificate check when establishing a connection, and certificates from the **Server Certificates / CA Certificates** lists that have become invalid (e.g. because they have expired).

You can remove certificates and download new certificates to the base, and you can also accept or reject invalid certificates.

If the connection to a data server on the Internet is not made because the phone does not accept the certificate received from the server (e.g. when downloading your e-mail messages from the POP3 server), you will be prompted to open the **Security** security settings web page.

The **Invalid Certificates** list contains the certificate used to make the connection. You can display information on the certificate by highlighting it and clicking on the **[Details]** button. This information includes who issued the certificate (certification authority) and for whom, as well as its validity period.

You must use the information to decide whether to accept or reject the certificate.

If you accept the certificate, depending on its type, it is transferred to one of the **Server Certificates / CA Certificates** lists (even if it has already expired). If a server responds again with this certificate, this connection is accepted immediately.

If you decline the certificate, it is transferred to the **(rejected)** list with the label **Server Certificates**. If a server responds again with this certificate, this connection is rejected immediately.

Managing base connections; activating/deactivating connections

You can manage your base connections using the web page:

Settings ▶ Telephony ▶ Connections

This web page displays a list with all possible connections and your status (e.g. connected, registered):

◆ Fixed Line Connection

You do not have to configure the fixed line network connection. You can make or receive calls on the fixed line network connection once your phone is connected to the fixed line network connection.

You can change the name of the fixed line network connection and the setting for the **Recall time** by clicking the corresponding **[Edit]** button.

The name entered is shown, e.g. for calls to your fixed line network connections, in the displays of the registered handsets and in the call list.

The flash time is set by default for operating the phone on the main connection. You must change it if necessary if you connect the phone to a PABX (see the user guide for your PABX). The flash time specifies the duration of the line interruption used to send control signals to the exchange or the telecommunications system (call transfer, setting up a consultation call etc.).

◆ Gigaset.net

The Gigaset.net connection is preconfigured in your phone. Your phone is preassigned a Gigaset.net number.

You can activate and deactivate the Gigaset.net connection. If the connection is deactivated, the phone will not register with the Gigaset.net service. You are then not available via the Gigaset.net connection.

Click the corresponding **[Edit]** button to change the name of the Gigaset.net connection and deactivate STUN.

The Gigaset.net connection uses a STUN server as standard. In the sent data packets, Gigaset.net replaces the private IP address of your phone with its public IP address.

If you operate your phone behind a router with symmetric NAT, STUN cannot be used. You must deactivate it. Otherwise, when making Gigaset.net calls you will not be able to hear the caller.

Configuring the phone via the Web configurator

◆ IP Connection

You can assign up to 6 VoIP connections (VoIP phone numbers) to your phone. You need to set up a VoIP account with a VoIP provider for each VoIP phone number. You must save the access data for each account and for the relevant VoIP provider in the phone.

A list entry is available for each VoIP connection; this is used to configure and manage the connection.

To do this, click on the corresponding **[Edit]** button.

Configuring/deleting VoIP connections

To configure and delete VoIP connections, open the web page

Settings ▶ Telephony ▶ Connections

Click on the **[Edit]** button next to the list entry for the VoIP connection.

This opens a web page with the following areas:

- ◆ **Auto Configuration**
- ◆ **Profile Download**
- ◆ **Personal Provider Data**
- ◆ **General data for your service provider**
- ◆ **Network data for your service provider**

For detailed information on the areas, see the online help for this web page. Open the online help by clicking on the question mark  (at the top right of the web page).

There are various ways of configuring a VoIP connection:

- ◆ Some providers support auto configuration with an auto configuration code. In this case you simply have to enter this code in the **Auto Configuration** area. All the required VoIP data is then downloaded into the areas specified above. The configuration is complete.
- ◆ Most providers supply provider profiles with the general provider data on the configuration server. Select your provider in the **Profile Download** area and download the provider profile to the phone. The profile data is downloaded into the **General data for your service provider** and **Network data for your service provider** areas.

You then have to enter the data for your VoIP account in the **Personal Provider Data** area.

In exceptional cases, you also have to adjust the settings in the **Network data for your service provider** area to suit the settings for your router:

- If you cannot hear the caller on an outgoing call, you may have to switch between outbound proxy server mode and STUN use. In the sent data packets, STUN or outbound server replaces the private IP address of your phone with its public IP address. If you operate your phone behind a router with symmetric NAT, STUN cannot be used.
- If you are sometimes unavailable for incoming calls, you may have to adjust the value in **NAT refresh time**:

If you have not activated port forwarding or set up a DMZ on the router for the phone, an entry in the routing table for the NAT (in the router) is required to make the phone available. The phone must confirm this entry in the routing table at certain intervals (**NAT refresh time**) so that the entry stays in the routing table.

- ◆ There is no provider profile for your provider.

If this is the case, you must change the settings in the **Personal Provider Data**, **General data for your service provider** and **Network data for your service provider** areas yourself. Your VoIP provider will supply you with this data.

Optimising voice quality for VoIP connections

Functions to improve the voice quality on VoIP connections are available on the web page:

Settings ▶ Telephony ▶ Audio

The voice quality for VoIP connections is mainly determined by the **voice codec** used for transferring the data and the available **bandwidth** of your DSL connection.

In the case of the voice codec, the voice data is digitised (coded/decoded) and compressed. A "better" codec (better voice quality) means more data needs to be transferred, i.e. perfect voice data transfer requires a DSL connection with a larger bandwidth.

You can change the voice quality by selecting (bearing in mind the bandwidth of your DSL connection) the voice codecs your phone is to use, and specifying the order in which the codecs are to be suggested when a VoIP connection is established.

Default settings for the codecs used are stored in your phone; one setting optimised for low bandwidths and one for high bandwidths.

You can generally select one of these standard settings for all VoIP connections on your phone. If your DSL connection has a low bandwidth, you can also exclude parallel VoIP connections to increase the voice quality.

You can also change the settings for the voice codecs yourself by selecting the voice codecs to be used for each VoIP connection on your phone and specifying the sequence in which they should be suggested when establishing a VoIP connection.

The following voice codecs are supported by your phone:

G.722

Excellent voice quality. The **broadband** voice codec **G.722** works at the same bit rate as G.711 (64 kbit/s per speech connection) but with a higher sampling rate. This allows higher frequencies to be played back. The speech tone is therefore clearer and better than with the other codecs (High Definition Sound Performance).

G.711 a law / G.711 μ law

Excellent voice quality (comparable with ISDN). The required bandwidth is 64 kbit/s per voice connection.

G.726

Good voice quality (inferior to that with G.711 but better than with G.729).

Your phone supports G.726 with a transmission rate of 32 kbit/s per voice connection.

G.729

Average voice quality. The necessary bandwidth is less than or equal to 8 kbit/s per voice connection.

To save additional bandwidth and transmission capacity on VoIP connections that use the **G.729** codec you can suppress the transmission of voice packets in pauses ("silence suppression"). Instead of the background noises in your environment, your caller then hears a synthetic noise generated in the receiver (option: **Enable Annex B for codec G.729**).

Note

Observe the following for good voice quality:

- ◆ When making calls using VoIP, avoid performing other Internet activities (e.g. surfing the Internet).
- ◆ Please note that voice delays can occur depending on the codec used and the network capacity utilisation.

Assigning send and receive connections

For the number assignment, open the web page:

Settings ▶ Telephony ▶ Number Assignment

Assign send and receive connections to the registered handsets.

The following should be observed:

- ◆ During registration, each handset is automatically assigned the fixed line network connection as a send connection and all base connections as receive connections.
- ◆ You can assign each handset either a fixed send connection or a line selection. With line selection, you choose the connection to be used for each call.
- ◆ The Gigaset.net number is fixed as the send connection for each registered handset. Numbers that end in #9 are automatically dialled via Gigaset.net.

Activating the fixed line network connection as the fallback send connection

You can activate the fixed line network connection on your phone as a fallback connection. If a call attempt fails via VoIP, an attempt is automatically made (without prompting) to establish a connection via the fixed line network.

A fallback is used in the following situations:

- ◆ Your VoIP connections are busy
- ◆ The SIP server for the VoIP connection cannot be accessed
- ◆ The dialled VoIP connection has not yet been configured or has not been configured correctly (e.g. incorrect password)
- ◆ The phone does not have a connection to the Internet, for example, because your router is deactivated or not connected to the Internet.

Exception

SMS messages that are to be sent via a VoIP connection are **not** sent via the fallback connection.

The option to activate the fallback connection is on the web page:

Settings ▶ Telephony ▶ Number Assignment

User-defined dialling plans – specifying rules for telephony

You can define your own dialling plans in the **Dialling Plans** area on the web page:

Settings ▶ Telephony ▶ Dialling Plans

You can specify the following dialling plans:

- ◆ You can define a connection (fixed line network or a VoIP connection) for specific phone numbers, which should always be used to dial these phone numbers and therefore also for billing.
If you enter just a few digits (e.g. local area, national or mobile network code) any call to a number beginning with these digits will be made via the selected connection.
- ◆ If you block specific phone numbers, your phone will not establish a connection to these numbers (e.g. 0190 or 0900 numbers).

These dialling plans apply to all registered handsets. The send connection settings are inactive when you dial numbers that are governed by a dialling plan.

You can activate and deactivate the dialling plans as required.

Note

Dialling plans, with the exception of a block, are not effective if you have assigned the line selection to a display key on the handset and you explicitly choose a send connection from the list of available connections before dialling.

Tips:

- ◆ Compare the rates for long-distance calls (especially for international calls) offered by your fixed line network and VoIP providers, and determine which connection should be used specifically for these countries/locations, e.g. a dialling plan for the **Phone Number** "0033" would apply to every call made to France.
- ◆ Use dialling plans to specify that numbers starting with a preselection number are always made via your fixed line network connection. To do so, enter the preselection number in the **Phone Number** field.

Note

If dialling plans overlap, the one with the greatest concordance will apply.

Example:

There is a dialling plan for the number "02" and one for the number "023". If you dial "0231..." the second plan will apply; if you dial "0208..." the first plan will apply.

Examples

All calls to the mobile phone network should be made via your VoIP connection with provider B.

Dialling plans:

Phone Number = 017 **Connection** = IP3, Provider B

and the corresponding entries for "015" and "016".

Configuring the phone via the Web configurator

Emergency numbers

Dialling plans for emergency numbers (e.g. the **local** police emergency number) are preset for certain countries. The fixed line network is set as the **Connection**.

You should only change these dialling plans if the telephone is not connected to the fixed line network. If you choose a VoIP connection, please make sure the VoIP provider supports calls to emergency numbers. If the VoIP connection is deleted from the configuration, the emergency call can no longer be made.

If no emergency numbers are set by default, you should define dialling plans for emergency numbers yourself and assign them to a connection that you know supports emergency calls.

Access codes – activating dialling plans when connecting to a PABX

If your phone is connected to a PABX, you may have to enter an access code for external calls (outside line code, e.g. "0").

Save one access code each for fixed line network and VoIP connections and specify separately for VoIP and fixed line network connections when the phone numbers should be automatically prefixed with the digits.

You can choose between "**All**", "**None**" and "**On Call Lists**".

These settings are available in the **Access Code** area on the web page:

Settings ▶ **Telephony** ▶ **Dialling Plans**

Local area codes – activating dialling plans for local calls using VoIP

If you use VoIP to make a call to the fixed line network, you may also have to dial the area code for local calls (depending on the provider). You can avoid having to enter your own local area code by entering the full area code (with the international code) for the location where you are using the phone in the phone configuration and activating the **Predial area code for local calls via VoIP** option.

These settings are available in the **Area Codes** area on the web page:

Settings ▶ **Management** ▶ **Local Settings**

Entering the network mailbox, enabling/disabling the network mailbox

A list of the network mailboxes for all connections on your phone is available on the web page:

Settings ▶ **Telephony** ▶ **Network Mailboxes**

You can enter the phone numbers for the network mailboxes in this list.

You can use this list to activate/deactivate the network mailboxes for all configured VoIP connections.

Making special settings for VoIP telephony

Activating Call Forwarding for VoIP connections

The settings for Call Forwarding are on the web page:

Settings ▶ Telephony ▶ Call Forwarding

You can divert calls to your VoIP connections and to your Gigaset.net number.

You can divert calls to your VoIP connections to any external number (VoIP, fixed line network or mobile number). Call Forwarding takes place via VoIP.

You can divert calls to your Gigaset.net number within the Gigaset.net, i.e. to another Gigaset.net number.

For each of your VoIP connections (VoIP accounts), you can determine if and when calls to the corresponding VoIP number should be diverted to a different VoIP phone number.

Setting DTMF signalling for VoIP

You can change the settings for DTMF signalling in the **DTMF over VoIP connections** area on the web page:

Settings ▶ Telephony ▶ Advanced VoIP Settings

DTMF signalling is required, for example, for querying and controlling certain network mailboxes via digit codes or for remote operation of a local answer machine.

To send DTMF signals via VoIP you must first define how key codes should be converted into and sent as DTMF signals: as audible information via the speech channel or as a "SIP Info" message. Ask your VoIP provider which type of DTMF transmission it supports.

You can configure your telephone in such a way that it attempts with each call to set the most suitable DTMF signalling for the current codec (**Automatic**).

Or you can explicitly define the type of DTMF signalling:

- ◆ **Audio** or **RFC 2833** if DTMF signals are to be transmitted acoustically (in voice packets).
- ◆ **SIP Info** if DTMF signals are to be transmitted as code.

Notes

- ◆ The settings for DTMF signalling apply to all VoIP connections (VoIP accounts).
- ◆ DTMF signals cannot be transmitted in the audio path (**Audio**) on broadband connections (the G.722 codec is used).

Configuring the phone via the Web configurator

Configuring call transfer via VoIP

You can change the settings for call transfer in the **Call Transfer** area on the web page:

Settings ▶ Telephony ▶ Advanced VoIP Settings

You can connect an external call to one of your VoIP connections with a second external participant (depending on the provider). You do this by establishing an external consultation call to the second participant and pressing the R key on the handset once the second participant has answered. The call is transferred.

You can expand or change the settings for call transfer as follows:

- ◆ You can activate call transfer by ending the call. The two external participants are connected with one another when you press the End call key  on the handset. Your connections with the participants are terminated.
- ◆ You can activate direct call transfer. You can then transfer the call before the second participant has answered.
- ◆ You can deactivate call transfer with the R key if you want to assign a different feature to the R key (see below "Defining R key function for VoIP (hook flash)").

Defining R key function for VoIP (hook flash)

You can specify the function for the R key on the web page:

Settings ▶ Telephony ▶ Advanced VoIP Settings

Your VoIP provider may support special performance features. To make use of these features, your phone needs to send a specific signal (data packet) to the SIP server. You can assign this "signal" as the R function to the R key on the handsets. **Prerequisite:** The R key is not used for call transfer (default setting, see above).

If you press this key during a VoIP call, the signal is sent. This requires that DTMF signalling via SIP info messages is activated on the phone (see above).

Defining local communication ports for VoIP

The settings for the communication ports are on the web page:

Settings ▶ Telephony ▶ Advanced VoIP Settings

The following communication ports are used for VoIP telephony:

◆ SIP port

The communication port via which the phone receives (SIP) signalling data. The default standard port number is set to 5060 for SIP signalling.

◆ RTP port

Two consecutive RTP ports (consecutive port numbers) are required for each VoIP connection. Voice data is received via one port and control data via the other. The default standard port number is set to 5004 - 5020.

This setting only has to be changed if the port numbers are already being used by other participants in the LAN. You can then specify other fixed port numbers or port number ranges for the SIP and RTP port.

If several VoIP phones are operated on the same router with NAT, it makes sense to use randomly selected ports. The phones must then use different ports so that the router's NAT is only able to forward incoming calls and voice data to one (the intended) phone. Use the Web configurator to specify a port number range for the SIP and RTP port that the ports are chosen from.

Making settings for access to Internet services

You can use the following Internet services on your phone.

◆ E-mail notifications

In order to use the e-mail function of your base on the handset, you have to save the address of the incoming e-mail server and your personal access data for your mailbox in the base.

You can also specify the time interval at which your phone should check whether the incoming e-mail server has received new e-mail messages, and specify whether authentication on the incoming e-mail server should be carried out via a secure connection.

You can change the settings on the web page:

Settings ▶ Messaging ▶ eMail

◆ MWI Light

The LED in the message key on the base connected with the handset indicates when a new message, e.g. a new e-mail, has been received. You can specify for each individual handset what kind of new message should be displayed.

You can change the settings on the web page:

Settings ▶ Messaging ▶ MWI Light

◆ Customising info services for the Info Centre and the Info Services screensaver

You can customise your personal services for your Info Centre (→ page 70) and for the screensaver **Info Services** (→ page 44).

You can access the Gigaset.net server (URL and personal access data) on the web page:

Settings ▶ Info Services

You can also activate the **Info Services** screensaver for your phone.

◆ Online directories

You have to select the provider whose online directories you want to use on the registered handsets.

You can set the **Display of caller's name** option, depending on the provider selected. This means that the name of the caller is read from the online directory for incoming calls and shown on the display (where the handset's local phonebook does not contain an entry for the caller's number).

You can change the settings on the web page:

Settings ▶ Directories ▶ Online Directory

◆ Managing the synchronisation of the base with a time server

By default, your phone is configured so that the date/time is transferred from a time server on the Internet.

Changes to the settings for the time server and activation/deactivation of the synchronisation are done via the web page:

Settings ▶ Management ▶ Date & Time

Deleting handset directories and downloading to/from the PC

The functions to edit the directories are on the web page:

Settings ▶ Directories ▶ Directory Transfer

The Web configurator has the following options for editing the directories of the registered handsets.

- ◆ Store the directories on a PC. Entries are stored in vCard format in a vcf file on the PC. You can download these files onto every registered handset. You can also copy phonebook entries to your PC address book.
- ◆ Copy contact details from your PC address book to handset directories. Export the contacts in vcf files (vCards) and transfer them to directories of the handsets with the Web configurator.
- ◆ Delete the phonebook on the handset.
If you have edited the phonebook file (vcf file) on the PC and would like to load this modified phonebook to the handset, you can delete the current phonebook on the handset before the transfer.

Tip: Back up the current phonebook on your PC before deleting it. You can then reload it if the modified phonebook is affected by formatting errors and some, or all, of it cannot be loaded onto the handset.

Notes

- ◆ You can find information on vCard format (vcf) on the Internet, e.g. at:
www.en.wikipedia.org/wiki/VCard (English)
www.de.wikipedia.org/wiki/VCard (German)
(You can set the display language at the bottom left side in the navigation area of the web page)
- ◆ If you wish to copy a phonebook (vcf file) with multiple entries stored on the PC to the Microsoft Outlook™ address book, please note the following:
Microsoft Outlook™ only ever transfers the first (directory) entry from the vcf file to its address book.

Transfer rules

The phonebook entries from a vcf file that are loaded onto the handset will be added to the directory. If an entry already exists for a name, it will either be supplemented or a new entry for the name will be created. The process will not overwrite or delete any phone numbers.

Note

Depending on your device type, up to three entries with the same name are created in the directory for each vCard – one entry per entered number.

Directory file content (vcf file)

The following data (if available) is written into the vcf file for entry into the directory or transferred from a vcf file into the handset phonebook:

- ◆ Name
- ◆ First name
- ◆ Number
- ◆ Number (office)
- ◆ Number (mobile)
- ◆ E-mail address
- ◆ Anniversary date (YYYY-MM-DD) and the time of the reminder call (HH:MM) separated by a "T" (e.g.: 2008-12-24T11:00).

Other information that a vCard may contain is not entered into the handset phonebook.

Example of an entry in vCard format:

```
BEGIN:VCARD
VERSION:2.1
N:Smith;Anna
TEL;HOME:1234567890
TEL;WORK:02991 23456
TEL;CELL:0175987654321
E-MAIL:anna@smith.com
BDAY:2008-12-24T11:00
END:VCARD
```

Changing the base settings, registering handsets

You can use the Web configurator to:

- ◆ Switch the base to registration mode to register more handsets to the base. This setting corresponds to pressing and holding the registration/paging key on the front of the base.
- ◆ Activate or deactivate Eco Mode or Eco Mode+. For Eco Mode see page 96.
- ◆ Change the system PIN (→ page 51) for your phone.
- ◆ Activate and deactivate the LED for the registration/paging key on the front of the base. See page 3 for the meaning of the LED.
- ◆ Activate or deactivate the display of VoIP status messages on your handset.

The base settings are on the web page

Settings ▶ Management ▶ Miscellaneous

Rebooting the device or restoring the factory settings

If your phone suddenly does not work as expected, you can restart it. This frequently resolves problems.

You can also reset all of the settings on the phone to the default settings e.g. if you want to give your phone to a third participant. This deletes all settings, lists and phonebook entries!

You can restart the device or restore the factory settings via the web page:

Settings ▶ Management ▶ Reboot & Reset

Saving and restoring system settings

Once you have configured your base and after each configuration change, you can save the current base settings in a file on the PC (suffix .cfg).

If you change the settings accidentally or you need to reset the base due to a fault (base reset), you can reload the saved settings from the file on your PC to your phone.

The contents of the .cfg file include:

- ◆ The settings for the local network (IP configuration)
- ◆ The data for the (VoIP) connections established
- ◆ The assignment of send and receive connections
- ◆ Your own local area code and access code
- ◆ The network mailbox number
- ◆ The Internet services settings
- ◆ The ECO DECT settings

You can save and restore the system settings via the web page:

Settings ▶ Management ▶ Save & Restore

Updating firmware for the base/restoring firmware updates, activating/deactivating automatic updates

You can start firmware updates and downgrades via the web page:

Settings ▶ Management ▶ Firmware Update

Regular updates to the base firmware and the provider profile for your VoIP connections (general provider data) are made available on an Internet configuration server. You can download these updates onto your base as required. The URL for this server is stored in the base.

You have the following options:

- ◆ Starting a firmware update

If a **new** version of the firmware is available, this is downloaded to the base and the base is restarted. A firmware update lasts approx. six minutes. The duration also depends on the bandwidth of your DSL connection.

- ◆ Enabling/disabling the automatic version check

When the version check is enabled, the phone checks on a daily basis whether the Gigaset configuration server has a new version of the phone firmware.

If the telephone is not connected to the Internet at the time when the check is to be performed (e.g. because the router is disabled), the check is performed as soon as the phone is reconnected to the Internet.

If a new version is available, a message to this effect is shown on the display of the registered handsets. You can start the update of the firmware on one of the handsets.

- ◆ Downgrading firmware

You have the following options:

- You can reload the firmware version that was loaded before the last update on the base.
- You can reload the firmware version that was loaded by default onto the phone.

The selected firmware is reloaded onto the phone and the current firmware is overwritten.

Displaying the phone status

The **Status** tab displays, for example, the following information about the phone on the **Device** page:

- ◆ IP and MAC address for the base
- ◆ Version of the firmware currently loaded
The version is shown in the following format: aabbxxyyzz
aa denotes the phone's product variant
bbb is the version of the firmware and xx the sub-version (yyzz are only significant for the service)
Edition 420200000 means that version 20 of the firmware is currently loaded on your base.
- ◆ A list of the registered handsets



The **Connections** page displays the currently available connections and their status.

Questions and answers

If you have any queries about the use of your telephone, suggested solutions are available on our website at

www.gigaset.com/service ▶ FAQ ▶ First steps for troubleshooting.

The table below also lists steps for troubleshooting.

<p>The display is blank.</p> <ol style="list-style-type: none"> The handset is not activated. <ul style="list-style-type: none"> Press and hold . The battery is empty. <ul style="list-style-type: none"> Charge the battery or replace it (→ page 11). The key and display lock is activated. <ul style="list-style-type: none"> Press and hold the hash key . The backlight is deactivated because a time control was activated (→ page 45). <ul style="list-style-type: none"> Press any key on the handset to temporarily activate the display backlight. Or: <ul style="list-style-type: none"> Deactivate time control (→ page 47).
<p>"No Base" flashes on the display.</p> <ol style="list-style-type: none"> The handset is outside the range of the base. <ul style="list-style-type: none"> Move the handset closer to the base. The base is not activated. <ul style="list-style-type: none"> Check the base power adapter. The base's range is reduced because Eco Mode is activated. <ul style="list-style-type: none"> Deactivate Eco Mode (→ page 96) or reduce the distance between the handset and base. The firmware is currently being updated. <ul style="list-style-type: none"> Please wait until the update is complete.
<p>"Please register handset" or "Place handset in base" flashes on the display.</p> <p>The handset has not been registered or was de-registered due to the registration of an additional handset (more than six DECT registrations).</p> <ul style="list-style-type: none"> Register the handset again (→ page 78).
<p>The handset does not ring.</p> <ol style="list-style-type: none"> The ringtone is deactivated. <ul style="list-style-type: none"> Activate ringtone (→ page 48). Call Forwarding is set to "All calls". <ul style="list-style-type: none"> Deactivate call divert (→ page 39). The connection on which the call is received is not assigned to the handset as a receive connection. <ul style="list-style-type: none"> Change the assignment of receive connections (→ page 55).
<p>You cannot hear a ringtone/dialling tone from the fixed line network.</p> <p>The supplied phone cable is not being used or the phone cable may be faulty.</p> <ul style="list-style-type: none"> Replace the phone cable. When purchasing from a phone retailer, ensure the cable has the correct jack pin connections (→ page 142).
<p>Some of the network services do not work as specified.</p> <p>Features are not activated.</p> <ul style="list-style-type: none"> Query with the network provider.

Error tone sounds after system PIN prompt.

You have entered the wrong system PIN.

- ▶ Repeat input of system PIN.

The other participant cannot hear you.

You have pressed the mute key . The handset is "muted".

- ▶ Activate the microphone again (→ page 35).

The caller's number is not displayed.

1. **Calling Line Identification (CLI)** is not approved for the caller.
 - ▶ The **caller** should ask the network provider to enable Calling Line Identification (CLI).
2. **Caller display (CLIP)** is not supported by the network provider or is not enabled for you.
 - ▶ Caller display (CLIP) must be enabled by the network provider.
3. Your telephone is connected via a PABX or a router with an integrated PABX (gateway) that does not transmit all information.
 - ▶ Reset the system: Briefly pull out the power plug. Reinsert the plug and wait until the device restarts.
 - ▶ Check the settings on the PABX and activate phone number display, if necessary. To do this, search for terms such as CLIP, calling line identification, phone number identification, caller ID, etc. in the system's user guide or ask the system manufacturer.

You hear an error tone when keying an input (descending tone sequence).

Action has failed/invalid input.

- ▶ Repeat the process.
Read the display and refer to the user guide if necessary.

No time is specified for a message in the call list.

Date/time are not set.

- ▶ Set date/time or
- ▶ Activate synchronisation with a time server on the Internet via the Web configurator.

Firmware update or VoIP profile download is not carried out.

1. If **Currently not possible** is displayed, the VoIP connections may be busy or a download/update is already being carried out.
 - ▶ Repeat the process at a later date.
2. If **File unreadable** is displayed, the firmware file may be invalid.
 - ▶ Use only the firmware available on the preconfigured Gigaset configuration server.
3. If **Server not accessible** is displayed, the download server may not be accessible.
 - ▶ The server is currently not accessible. Repeat the process at a later date.
 - ▶ You have changed the preconfigured server address. Correct the address. If necessary, reset the base.
4. If **Transmission error XXX** is displayed, an error has occurred during the transmission of the file. An HTTP error code is displayed in place of XXX.
 - ▶ Repeat the process. If the error occurs again, consult the Service department.
5. If **Check IP settings** is displayed, your phone may not be connected to the Internet.
 - ▶ Check the cable connections between the base and router and between the router and the Internet.
 - ▶ Check whether the phone is connected to the LAN, i.e. it can be reached at its IP address.

You cannot establish a connection to the phone with your PC's web browser.

- ▶ When establishing a connection, check the phone's local IP address that has been entered. You can check the IP address on your handset (→ page 52).
- ▶ Check the connections between the PC and base. Transmit a ping command to your base, e.g. from your PC (ping <base's local IP address>).
- ▶ You have tried to reach the phone via a secure http (https://...). Try again with http://...

Information on operating Gigaset VoIP telephones with routers with Network Address Translation (NAT)

In general no special telephone or router configuration is required when operating a Gigaset VoIP phone with NAT router. The configuration settings described in this section are only necessary if you encounter one of the following problems.

Typical problems caused by NAT

- ◆ No incoming calls are possible via VoIP. Calls to your VoIP phone number are not put through.
- ◆ Outgoing calls via VoIP are not connected.
- ◆ A connection is established with the other participant, but you cannot hear them and/or they cannot hear you.

Possible solution

- 1** Change the port numbers of the communication ports (SIP and RTP ports) on your phone (→ "1. Changing the port numbers for SIP and RTP on your VoIP phone").
- 2** In some cases, you must also define port forwarding for the phone's communication ports on the router (→ "2. Setting port forwarding on the router").

1. Changing the port numbers for SIP and RTP on your VoIP phone

On your VoIP phone, define different (local) port numbers for the SIP and RTP ports (between 1024 and 49152).

- ◆ These numbers must not be used by any other application or host in the LAN and
- ◆ Must be considerably higher or lower than the SIP and RTP port numbers that you usually use (and are preset on the phone).

This procedure is particularly useful if additional VoIP phones are connected to the router.

To change the SIP and RTP port numbers on your VoIP phone, proceed as follows:

- ▶ Connect your PC's browser to the Web configurator of the phone and log in.
- ▶ Open the web page **Settings ▶ Telephony ▶ Advanced VoIP Settings** and change the settings for the SIP and RTP ports (→ page 124).
To help you remember the new port numbers (e.g. for router configuration), you can choose port numbers that are very similar to the standard settings, e.g.:

SIP port	49060	instead of	5060
RTP port	49004 to 49010	instead of	5004 to 5010

- ▶ Save the changes on your phone.
- ▶ Wait for the active VoIP connections to be re-registered. To do so, switch to the web page **Settings ▶ Telephony ▶ Connections** to see the **Status** of your VoIP connections.
- ▶ Check to see whether the problem persists. If it does, perform step 2.

2. Setting port forwarding on the router

To ensure that your specified SIP and RTP port numbers are used on the WAN interface with the public IP address, you must define port forwarding rules for the SIP and RTP ports on the router.

To define port forwarding on the router, proceed as follows:

The terms used below may vary from router to router.

To release a port, you must enter the following details (example):

Protocol	Public port	Local port	Local host (IP)	
UDP	49060	49060	192.168.2.10	for SIP
UDP	49004 – 49010	49004 – 49010	192.168.2.10	for RTP

Protocol

Enter **UDP** as the protocol to be used.

Public port

Port number/port number range on the WAN interface

Local port

The SIP and RTP port numbers set on the phone.

In the new firmware version for Gigaset VoIP telephones, you can set a RTP port range. You must then also define corresponding port forwarding for this range.

Local host (IP)

Local IP address of your phone in the LAN. You can see the phone's current IP address in the handset display by pressing the paging key on the base.

To enable the router to perform this port forwarding, the DHCP settings of the router must ensure that the phone is always assigned the same local IP address, i.e. the DHCP does not change the IP address assigned to the phone during operation. Alternatively, you can assign a fixed (static) IP address to the phone. However, you must ensure that this IP address is not within the address range reserved for DHCP and is not assigned to any other LAN participant.

VoIP status codes

The following tables show the meaning of the most important VoIP status codes and messages.

Status code	Meaning
0x31	IP configuration error: IP domain not entered.
0x33	IP configuration error: SIP username (User ID) not entered. This is shown, for example, when dialling with a line suffix, if no connection is configured for the suffix on the base.
0x34	IP configuration error: SIP password (Password) not entered.
0x300	The called participant can be reached under multiple phone numbers. If the VoIP provider supports this, a list of the phone numbers is transmitted as well as the status code. The caller can select the number to which he/she wants to make the connection.
0x301	Permanently diverted. The called participant can no longer be reached under this number. The new number is transferred to the phone together with the status code and the phone then no longer accesses the old number but dials the new address immediately.
0x302	Temporarily diverted. The phone is informed that the called participant cannot be reached under the dialled number. The call is diverted for a limited period. The phone is also notified of the length of the diversion.
0x305	The query is sent to a different "proxy server", e.g. to balance incoming queries. The phone will make the same query to another proxy server. This is not a redirection of the address per se.
0x380	Other service: The query or call could not be transferred. However, the phone is informed of the other options available to connect the call.
0x400	Wrong call
0x401	Not authorised
0x403	The requested service is not supported by the VoIP provider.
0x404	Wrong phone number. No connection on this number. Example: While making a local call you have not dialled the area code although your VoIP provider does not support local calls.
0x405	Method not permitted.
0x406	Not acceptable. The requested service cannot be provided.
0x407	Proxy authentication required.
0x408	The participant cannot be reached (e.g. account has been deleted).
0x410	The requested service is not available from the VoIP provider.
0x413	Message is too long.
0x414	URI is too long.
0x415	Query format is not supported.
0x416	URI is faulty.

Customer Service & Assistance

Status code	Meaning
0x420	Incorrect ending
0x421	Incorrect ending
0x423	The requested service is not supported by the VoIP provider.
0x480	The dialled number is temporarily unavailable.
0x481	The recipient is not available.
0x482	Double service query
0x483	Too many "hops": The query was rejected because the service server (proxy) has decided that this query has already passed through too many service servers. The maximum number is defined beforehand by the original sender of the query.
0x484	Wrong number: In most cases this response means that you have simply omitted one or more digits in the phone number.
0x485	The URI dialled is not unique and cannot be processed by the VoIP provider.
0x486	The called participant is busy.
0x487	General error: The call was cancelled before a call was established. The status code confirms receipt of the interruption signal.
0x488	The server cannot process the query because the data entered in the media description is not compatible.
0x491	The server reports that the query will be processed as soon as a previous query has been completed.
0x493	The server rejects the query because the phone cannot decrypt the message. The sender has used an encryption method that neither the server nor the receiver phone can decrypt.
0x500	The proxy or the receiving device has discovered a fault while executing the query. It is therefore impossible to execute the query. If this occurs, the caller or the phone displays the fault and repeats the query after a few seconds. If applicable, the number of seconds after which the query can be repeated may be transmitted to the caller or phone by the receiving device.
0x501	The query cannot be processed by the recipient because the recipient does not have the functionality that the caller requires. If the recipient understands the query but does not process it because the sender does not have the necessary rights or the query is not permitted in the current context, status code 405 is transmitted instead of 501.
0x502	In this case, the receiving device that transmits this error code is a proxy or a gateway and has received an invalid response from its gateway via which this query is to be processed.
0x503	The query cannot be processed by the receiving device or the proxy at present because the server is either overloaded or is being serviced. If it is possible for the query to be repeated in the foreseeable future, the server informs the caller or the phone.
0x504	Time limit exceeded at the gateway
0x505	The server rejects the query because the indicated version number of the SIP protocol does not concur with at least the version that is used by the server or SIP device involved in this query.
0x515	The server rejects the query because the message exceeds the maximum permitted size.
0x600	The called participant is busy.
0x603	The called participant has rejected the call.

Status code	Meaning
0x604	The called URI does not exist.
0x606	The communication settings are not acceptable.
0x701	The called participant has hung up.
0x703	Connection cancelled because of timeout.
0x704	Connection interrupted because of an SIP error.
0x705	Wrong dialling tone
0x706	No connection established
0x751	Busy tone: No codec match between the calling and called participant.
0x810	General socket layer error: User is not authorised.
0x811	General socket layer error: Wrong socket number
0x812	General socket layer error: Socket is not connected.
0x813	General socket layer error: Memory error
0x814	General socket layer error: Socket not available – check IP settings/connection problem/VoIP setting incorrect.
0x815	General socket layer error: Illegal application on the socket interface.

Checking service information

If you contact Customer Care, you may need the base's service information.

Prerequisite: You have assigned an outside line (try to establish an external call, make an external call).

Note

You may need to wait a few seconds before **Options** appears on the display

Options ▶ Service Info ▶ OK

You can select the following information/functions with :

- 1: Serial number of the base (RFPI)
- 2: Empty: - - -
- 3: Informs the service employees of the base station settings (in hex diagram), e.g. the number of registered handsets, repeater mode.
- 4: Mode (digits 1 to 2),
Version of the phone's firmware (digits 3 to 5).
- 5: Gigaset.net number of your phone. A service employee can use this number to call you over the Internet without you needing to be registered with a VoIP provider. This means that the employee can test online connections and VoIP telephony regardless of the VoIP provider.
- 6: Device number of the base station. This contains additional information for the service employee.

Unlock system

(only if the device has been locked by the provider)

Confirm selection by pressing **OK**.

If necessary, you can unlock a provider-specific device lock with a corresponding code.

Update profile

Confirm selection by pressing **OK**.

Your current VoIP provider profiles (general provider data for all configured VoIP connections) are automatically downloaded to your phone. The general settings for all VoIP connections for which profiles are available on the Internet are updated.

Send config.

Select this option only if you are requested to do so by the service employee.

Authorisation

This device is intended for analogue phone lines in your network.

Voice over IP telephony is possible via the LAN interface (IEEE 802.3).

Depending on your telecommunication network interface, an additional modem could be necessary.

For further information please contact your Internet provider.

Country-specific requirements have been taken into consideration.

We, Gigaset Communications GmbH, declare that this device meets the essential requirements and other relevant regulations laid down in Directive 1999/5/EC.

A copy of the Declaration of Conformity is available at this Internet address:

www.gigaset.com/docs



Exclusion of liability

Your handset display has a resolution of 128 x 160 pixels. Each pixel consists of three sub-pixels (red, green, blue).

It may be the case that a pixel is incorrectly controlled or has a colour deviation. **This is normal and no reason for a warranty claim.**

The following table shows the number of pixel errors that may occur without leading to a warranty claim.

Description	Maximum number of permitted pixel errors
Colour illuminated sub-pixels	1
Dark sub-pixels	1
Total number of coloured and dark sub-pixels	1

Note

Signs of wear on the display and casing are excluded from the warranty.

Environment

Our environmental statement

We at Gigaset Communications GmbH are aware of our social responsibility. That is why we actively take steps to create a better world. In all areas of our business – from product planning and production to sales and waste of disposal – following our environmental conscience in everything we do is of utmost importance to us.

Learn more about our earth-friendly products and processes online at www.gigaset.com.

Environmental management system



Gigaset Communications GmbH is certified pursuant to the international standards ISO 14001 and ISO 9001.

ISO 14001 (Environment): Certified since September 2007 by TÜV SÜD Management Service GmbH.

ISO 9001 (Quality): Certified since 17/02/1994 by TÜV SÜD Management Service GmbH.

Disposal

Batteries should not be disposed of in general household waste. Observe the local waste disposal regulations, details of which can be obtained from your local authority.

All electrical and electronic products should be disposed of separately from the municipal waste stream via designated collection facilities appointed by the government or the local authorities.



This crossed-out wheeled bin symbol on the product means the product is covered by the European Directive 2002/96/EC.

The correct disposal and separate collection of your old appliance will help prevent potential negative consequences for the environment and human health. It is a precondition for reuse and recycling of used electrical and electronic equipment.

For more detailed information about disposal of your old appliance, please contact your local council refuse centre or the original supplier of the product.

Appendix

Caring for your telephone

Wipe the device with a **damp** cloth or an antistatic cloth. Do not use solvents or microfibre cloths.

Never use a dry cloth; this can cause static.

In rare cases, contact with chemical substances can cause changes to the device's exterior. Due to the wide variety of chemical products available on the market, it was not possible to test all substances.

Impairments in high-gloss finishes can be carefully removed using display polishes for mobile phones.

Contact with liquid

If the device comes into contact with liquid:

- 1 **Disconnect the power supply.**
- 2 **Remove the batteries and leave the battery compartment open.**
- 3 Allow the liquid to drain from the device.
- 4 Pat all parts dry.
- 5 Place the device in a dry, warm place **for at least 72 hours (not in a microwave, oven etc.)** with the battery compartment open and the keypad facing down (if applicable).
- 6 **Do not switch on the device again until it is completely dry.**

When it has fully dried out, you will normally be able to use it again.

Technical data

Batteries

Technology: 2 x AAA NiMH

Voltage: 1.2 V

Capacity: 800 mAh

Handset operating times/charging times

The operating time of your Gigaset depends on the capacity of the battery, its age and the way it is used. (All times are maximum possible times).

Standby time (hours) *	320 * 170 **
Talktime (hours)	14
Operating time for 1.5 hours of calls per day (hours) *	130 * 100 **
Charging time in base (hours)	8.5
Charging time in charging cradle (hours)	6

* ECO DECT deactivated, **without** display backlight in idle status

** ECO DECT activated, **without** display backlight in idle status

Base power consumption

Standby: approx. 1.2 watt

During a call: approx. 1.3 watt

General specifications

Interfaces	Analogue fixed line network, Ethernet
DECT standard	Supported
GAP standard	Supported
No. of channels	60 duplex channels
Radio frequency range	1880-1900 MHz
Duplex method	Time division multiplexing, 10 ms frame length
Repetition frequency of the transmission pulse	100 Hz
Duration of the transmission pulse	370 μ s
Channel grid	1728 kHz
Bit rate	1152 kbit/s
Modulation	GFSK
Language code	32 kbit/s
Transmission power	10 mW average power per channel. 250 mW pulse power
Range	Up to 300 m outdoors, up to 50 m indoors
Power supply	230 V ~/50 Hz
Environmental conditions for operation	+5°C to +45°C, 20% to 75% relative humidity
Dialling mode	DTMF (tone dialling)/PD (pulse dialling)
Codec	G.711, G.726, G.729AB with VAD/CNG, G.722
Quality of Service	TOS, DiffServ
Protocols	SIP, RTP, DHCP, NAT Traversal (STUN), HTTP



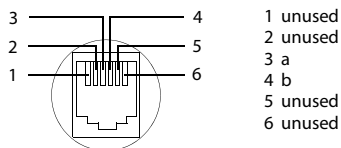

Pin connections on the fixed line network telephone jack



Character charts

Standard characters

Press the relevant key the number of times indicated.

	1x	2x	3x	4x	5x	6x	7x	8x	9x	10x
1 	1									
2 	a	b	c	2	ä	á	à	â	ã	ç
3 	d	e	f	3	ë	é	è	ê		
4 	g	h	i	4	ï	í	ì	î		
5 	j	k	l	5						
6 	m	n	o	6	ö	ñ	ó	ò	ô	õ
7 	p	q	r	s	7	ß				
8 	t	u	v	8	ü	ú	ù	û		
9 	w	x	y	z	9	ÿ	ý	æ	ø	å
0 	 ¹⁾	.	,	?	!	 ²⁾	0			

1)Space

2)Line break

Glossary

A

ADSL

Asymmetric Digital Subscriber Line
Special form of **DSL**.

ALG

Application Layer Gateway

NAT control mechanism of a router.

Many routers with integrated NAT use ALG. ALG lets the data packets in a VoIP connection pass and adds the public IP address of the secure private network.

The router's ALG should be deactivated if the VoIP provider offers a STUN server or an outbound proxy.

See also: **Firewall, NAT, Outbound Proxy, STUN**.

Authentication

Restriction of access to a network/service by using an ID and password to log in.

Automatic ringback

See **Ringback when busy**.

B

Block dialling

Enter the complete phone number, and correct it if necessary. Then pick up the earpiece or press the Talk/handsfree key to dial the phone number.

Broadband Internet access

See **DSL**.

C

Call Forwarding

CF
Automatic forwarding of a call to a different telephone number. There are three kinds of Call Forwarding:

- CFU, Call Forwarding Unconditional
- CFB, Call Forwarding Busy
- CFNR, Call Forwarding No Reply

Call swapping

Call swapping allows you to switch between two callers or between a conference and an individual caller without allowing the waiting caller to listen to the call.

Call waiting

= CW.

Network provider feature. A beep during a call indicates that another caller is waiting. You can accept or reject the second call. You can activate/deactivate the feature.

CF

Call Forwarding

See **Call Forwarding**.

Client

Application that requests a service from a server.

Codec

Coder/decoder

Codec is a procedure that digitalises and compresses analogue voice before it is sent via the Internet, and decodes – i.e. translates into analogue voice – digital data when voice packets are received. There are different codecs that vary, for instance, in the level of compression.

Both participants involved in the telephone connection (caller/sender and recipient) must use the same codec. This is negotiated between the sender and the recipient when establishing a connection.

The choice of codec is a compromise between voice quality, transmission speed and the necessary bandwidth. A high level of compression, for example, means that the bandwidth required for each voice connection is low. However, it also means that the time needed to compress/decompress the data is greater, which increases execution time for data in the network and thus impairs voice quality. The time required increases the delay between the sender speaking and the recipient hearing what has been said.

COLP / COLR

Connected Line Identification Presentation/Restriction

Feature provided by a VoIP/ISDN connection for outgoing calls.

COLP displays the phone number accepting the call on the calling participant's display unit.

The number of the participant accepting the call is different to the dialled number, e.g. if the call is diverted or transferred.

The called participant can use COLR (Connected Line Identification Restriction) to prevent the number from appearing on the calling participant's display.

Consultation call

You are on a call. With a consultation call, you interrupt the conversation briefly to establish a second connection to another participant. If you end the connection to this participant immediately, then this was a consultation call. If you switch between the first and second participant, it is called **Call swapping**.

CW

Call Waiting

See **Call waiting**.

D**DHCP**

Dynamic Host Configuration Protocol

Internet protocol that handles the automatic assignment of **IP addresses** to **Network subscriber**. The protocol is made available in the network by a server. A DHCP server can, for example, be a router.

The phone contains a DHCP client. A router that contains a DHCP server can assign the IP addresses for the phone automatically from a defined address block. The dynamic assignment means that several **Network subscribers** can share one IP address, although they can only use it alternately and not simultaneously.

With some routers you can specify that the IP address for the phone is never changed.

Displayed name

VoIP provider feature. You can specify any name that is to be shown to the other participant during a call instead of your phone number.

Glossary

DMZ (Demilitarised Zone)

DMZ describes a part of a network that is outside the firewall.

A DMZ is set up, as it were, between a network you want to protect (e.g. a LAN) and a non-secure network (e.g. the Internet). A DMZ permits unrestricted access from the Internet to only one or a few network components, while the other network components remain secure behind the firewall.

DNS

Domain Name System

Hierarchical system that permits the assignment of **IP addresses** to **Domain Names** that are easier to memorise. This assignment has to be managed by a local DNS server in each (W)LAN. The local DNS server determines the IP address, if necessary by enquiring about superordinate DNS servers and other local DNS servers on the Internet.

You can specify the IP address of the primary/secondary DNS server.

See also: **DynDNS**.

Domain Name

Name of one (of several) web server(s) on the Internet (e.g. Gigaset.net). The domain name is assigned to the relevant IP address by DNS.

DSCP

Differentiated Service Code Point

See **Quality of Service (QoS)**.

DSL

Digital Subscriber Line

Data transfer technology which allows Internet access of e.g. **1.5 Mbps** over conventional phone lines. Prerequisites: DSL modem and the appropriate service offered by the Internet provider.

DSLAM

Digital Subscriber Line Access Multiplexer

The DSLAM is a switch cabinet in an exchange where all subscriber connectors converge.

DTMF

Dual Tone Multi-Frequency

Another description for dual tone multi-frequency dialling (DTMF).

Dynamic IP address

A dynamic IP address is assigned to a network component automatically via **DHCP**. The dynamic IP address for a network component can change every time it registers or at certain time intervals.

See also: **Fixed IP address**

DynDNS

Dynamic DNS

Domain names and IP addresses are assigned via **DNS**. For **Dynamic IP addresses** this service is enhanced with "Dynamic DNS". This permits the use of a network component with a dynamic IP address as a **Server** on the **Internet**. DynDNS ensures that a service can always be addressed on the Internet under the same **Domain Names** irrespective of the current IP address.

E**ECT**

Explicit Call Transfer

Participant A calls participant B. The participant puts the connection on hold and calls participant C. Rather than connect everyone in a three-participant conference, A now transfers participant B to C and hangs up.

EEPROM

Electrically Erasable Programmable Read Only Memory

Memory building block in your phone with fixed data (e.g. default and customised settings) and data saved automatically (e.g. call list entries).

Ethernet network

Wired LAN.

F**Firewall**

You can use a firewall to protect your network against unauthorised external access. This involves combining various measures and technologies (hardware and/or software) to control the flow of data between a private network you wish to protect and an unprotected network (e.g. the Internet).

See also: **NAT**.

Firmware

Device software in which basic information is saved for the functioning of a device. To correct errors or update the device software, a new version of the firmware can be loaded into the device's memory (firmware update).

Fixed IP address

A fixed IP address is assigned to a network component manually during network configuration. Unlike the **Dynamic IP address**, a fixed IP address does not change.

Flat rate

System of billing for an **Internet** connection. The Internet provider charges a set monthly fee. There are no additional charges for the duration of the connection or number of connections.

Fragmentation

Data packets that are too big are split into smaller packets (fragments) before they are transferred. They are put together again when they reach the recipient (defragmented).

Full duplex

Data transmission mode in which data can be sent and received at the same time.

G**G.711 a law, G.711 μ law**

Standard for a **Codec**.

G.711 delivers a very good voice quality that corresponds to that in the ISDN network. As there is little compression, the necessary bandwidth is around 64 kbit/s per voice connection, but the delay caused by coding/decoding is only approx. 0.125 ms.

"a law" describes the European standard and " μ law" describes the North American/Japanese equivalent.

Glossary

G.722

Standard for a **Codec**.

G.722 is a **broadband** language codec with a bandwidth of 50 Hz to 7 kHz, a net transmission rate of 64 kbit/s per voice connection and integrated speech pause recognition and comfort noise generation (silence suppression).

G.722 delivers a very good voice quality. A higher sampling rate provides clearer and better voice quality than with other codecs and enables a speech tone in High Definition Sound Performance (HDSP).

G.726

Standard for a **Codec**.

G.726 delivers a good voice quality. It is inferior to the quality with codec **G.711** but better than with **G.729**.

G.729A/B

Standard for a **Codec**.

The voice quality is more likely to be lower with G.729A/B. As a result of the high level of compression, the necessary bandwidth is only around 8 kbit/s per voice connection, but the delay is around 15 ms.

Gateway

Connects two different **Networks**, e.g. a router as an Internet gateway.

For phone calls from **VoIP** to the telephone network, a gateway has to be connected to the IP network and the telephone network (gateway/VoIP provider). It forwards calls from VoIP to the telephone network as required.

Gateway provider

See **SIP provider**.

Global IP address

See **IP address**.

GSM

Global System for Mobile Communication

Originally a European standard for mobile networks. GSM can now be described as a worldwide standard. However, in the USA and Japan, national standards were previously more frequently supported.

H

Headset

Combination of microphone and headphones. A headset makes using handsfree mode more convenient. Headsets that can be connected to the base via a cable (wire-bound) or via Bluetooth (wireless) are available.

HTTP Proxy

Server via which the **Network subscribers** can process their Internet traffic.

Hub

Uses one **Infrastructure network** to connect several **Network subscribers**. All data sent to the hub by one network subscriber is forwarded to all network subscribers.

See also: **Gateway**, **Router**.

I

IEEE

Institute of Electrical and Electronics Engineers

International body that defines standards in electronics and electrical engineering, concerned in particular with the standardisation of LAN technology, transmission protocols, data transfer rate and wiring.

Infrastructure network

Network with a central structure: All **Network subscribers** communicate using a central **Router**.

Internet

Global **WAN**. A series of protocols known as TCP/IP have been defined for exchanging data.

Network subscribers are identifiable via their **IP address**. **DNS** assigns an **IP address** to **Domain Names**.

Important services on the Internet include the World Wide Web (WWW), e-mail, file transfer and discussion forums.

Internet Service Provider

Enables access to the Internet for a fee.

IP (Internet Protocol)

TCP/IP protocol on the **Internet**. It is responsible for the addressing of subscribers in a **Network** using **IP addresses** and routes data from the sender to the recipient. IP determines the paths (routing) along which the data packets travel.

IP address

A unique address for a network component within a network based on the TCP/IP protocols (e.g. LAN, Internet). On the **Internet**, domain names are usually assigned instead of IP addresses. **DNS** assigns the corresponding IP address to the domain name.

The IP address has four parts (decimal numbers between 0 and 255) separated by full stops (e.g. 230.94.233.2).

The IP address is made up of the network number and the number of the **Network subscriber** (e.g. phone). Depending on the Subnet mask, the first, second or third part makes up the network number and the rest of the IP address addresses the network component. The network number of all the components in any one network must be identical.

IP addresses can be assigned automatically with DHCP (dynamic IP addresses) or manually (fixed IP addresses).

See also: **DHCP**.

IP pool range

Range of IP addresses that the DHCP server can use to assign dynamic IP addresses.

L

LAN

Local Area Network

Network with a restricted physical range. A LAN can be wireless (WLAN) and/or wired.

Local IP address

The local or private IP address is the address for a network component in the local network (LAN). The network operator can assign any address they want. Devices that act as a link from a local network to the Internet (gateway or router) have a public and a private IP address.

See also **IP address**.

Glossary

Local SIP port

See **SIP port / local SIP port**.

M

MAC address

Media Access Control Address

Hardware address by means of which each network device (e.g. network card, switch, phone) can be uniquely identified worldwide. It consists of six parts (hexadecimal numbers) separated by a "-" (e.g. 00-90-65-44-00-3A).

The MAC address is assigned by the manufacturer and cannot be changed.

Mbps

Million bits per second

Unit of the transmission speed in a network.

MRU

Maximum Receive Unit

Defines the maximum user data volume within a data packet.

MTU

Maximum Transmission Unit

Defines the maximum length of a data packet that can be carried over the network at a time.

Music on hold

Hold music

Music that is played while you are on a **Consultation call** or during **Call swapping**. The waiting participant hears music while on hold.

N

NAT

Network Address Translation

Method for converting (private) **IP addresses** to one or more (public) IP addresses. NAT enables the IP addresses of **Network subscribers** (e.g. VoIP telephones) in a **LAN** to be concealed behind a shared IP address for the **Routers** on the **Internet**.

VoIP telephones behind a NAT router cannot be reached by VoIP servers (on account of the private IP address). To "get around" NAT, it is possible to use either **ALG** in the router, **STUN** in the VoIP telephone, or for the VoIP provider to use an **Outbound Proxy**.

If an outbound proxy is made available, you must allow for this in the VoIP settings for your phone.

Network

Group of devices. Devices can be connected in either wired or wireless mode.

Networks can also differ in range and structure:

- Range: Local networks (**LAN**) or wide-area networks (**WAN**)
- Structure: **Infrastructure network** or ad-hoc network

Network subscriber

Devices and computers that are connected to each other in a network e.g. servers, PCs and phones.

O

Outbound Proxy

Alternative NAT control mechanism to STUN and ALG.

Outbound proxies are implemented by the VoIP provider in firewall/NAT environments as an alternative to **SIP proxy servers**. They control data traffic through the firewall.

Outbound proxy and STUN servers should not be used simultaneously.

See also: **STUN** and **NAT**.

P

Paging (handset search)

(German: Funkruf)

Base function for locating the registered handsets. The base establishes a connection to every registered handset. The handsets start to ring.

PIN

Personal Identification Number

Protects against unauthorised use. When the PIN is activated, a number combination has to be entered to access a protected area.

You can protect your base configuration data with a system PIN (4-digit number combination).

Port

Data is exchanged between two applications in a **Network** across a port.

Port forwarding

The Internet gateway (e.g. your router) forwards data packets from the **Internet** that are directed to a certain **Port** to the port concerned. This allows servers in the **LAN** to offer services on the Internet without you needing a public IP address.

Port number

Indicates a specific application of a **Network subscriber**. Depending on the setting in the **LAN**, the port number is permanently assigned or it is assigned with each access.

The combination of **IP address/Port** number uniquely identifies the recipient or sender of a data packet within a network.

Pre-dialling

See **Block dialling**.

Private IP address

See **Public IP address**.

Protocol

Describes the agreements for communicating within a **Network**. It contains rules for opening, administering and closing a connection, about data formats, time frames and possible error handling.

Proxy/Proxy server

Computer program that controls the exchange of data between **Client** and **Server** in computer networks. If the phone sends a query to the VoIP server, the proxy acts as a server towards the phone and as a client towards the server. A proxy is addressed via **IP address/Domain Names** and **Port**.

Glossary

Public IP address

The public IP address is the address for a network component on the Internet. It is assigned by the Internet service provider. Devices that act as a link from a local network to the Internet (gateway or router) have a public and a local IP address.

See also: **IP address**, **NAT**

Q

Quality of Service (QoS)

Quality of Service

Describes the quality of service in communication networks. Differentiations are made between various quality of service classes.

QoS influences the flow of data packets on the Internet, e.g. by prioritising data packets, reserving bandwidth and optimising data packets.

In VoIP networks, QoS influences the voice quality. If the entire infrastructure (router, network server etc.) has QoS, voice quality is higher, e.g. fewer delays, less echoing, less crackling etc.

R

RAM

Random Access Memory

Memory in which you have reading and storage rights. Items such as melodies and logos are saved in the RAM after you have loaded them onto the phone via the Web configurator.

Registrar

The registrar manages the current IP addresses of the **Network subscriber**. When you register with your VoIP provider, your current IP address is saved on the registrar. This means you can also be reached when on the move.

Ringback when busy

= CCBS (Completion of calls to busy subscriber). If a caller hears the busy tone, he or she can activate the ringback function. As soon as the connection is free, the caller is called back. As soon as the caller lifts the earpiece, the connection is made automatically.

Ringback when the call is not answered

= CCNR (Completion of calls on no reply). If a participant does not reply when called, a caller can arrange an automatic ringback. As soon as the destination phone has completed a call and is free again, the caller is rung back. This feature must be supported by the exchange. The ringback request is automatically cancelled after about two hours (depending on the network provider).

ROM

Read Only Memory

A type of memory that can only be read.

Router

Routes data packets within a network and between different networks via the quickest route. Can connect **Ethernet networks** and WLAN. Can be a **Gateway** to the Internet.

Routing

Routing is the transfer of data packets to another subscriber in your network. On their way to the recipient, the data packets are sent from one network node to the next until they reach their destination.

If data packets were not forwarded in this way, a network like the Internet would not be possible. Routing connects the individual networks to this global system.

A router is a part of this system; it transfers data packets both within a local network and from one network to the next. Transfer of data from one network to another is performed on the basis of a common protocol.

RTP

Real-Time Transport Protocol

Global standard for transferring audio and video data. Often used in conjunction with UDP. In this case, RTP packets are embedded in UDP packets.

RTP port

(Local) **Port** that is used to send and receive voice data packets for VoIP.

S

Server

Provides a service to other **Network subscribers (Clients)**. The term can indicate a computer/PC or an application. A server is addressed via **IP address/Domain Names** and **Port**.

SIP (Session Initiation Protocol)

Signalling protocol independent of voice communication. Used for establishing and ending a call. It is also possible to define parameters for voice transmission.

SIP address

See **URI**.

SIP port / local SIP port

(Local) **Port** that is used to send and receive SIP signalling data packets for VoIP.

SIP provider

See **VoIP provider**.

SIP proxy server

IP address of your VoIP provider's gateway server.

Static IP address

See **Fixed IP address**.

STUN

Simple Transversal of UDP over NAT

NAT control mechanism.

STUN is a data protocol for VoIP telephones. STUN replaces the private IP address in the VoIP telephone data packets with the public address of the secure private network. To control data transfer, a STUN server is also required on the Internet. STUN cannot be implemented with symmetric NATs.

See also: **ALG, Firewall, NAT, Outbound Proxy**.

Subnet

Segment of a **Network**.

Glossary

Subnet mask

IP addresses consist of a fixed network number and a variable subscriber number. The network number is identical for all **Network subscribers**. Which portion of the IP address is the network number is determined in the subnet mask. In the subnet mask 255.255.255.0, for example, the first three parts of the IP address are the network number and the last part is the subscriber number.

Symmetric NAT

A symmetric NAT assigns different external IP addresses and port numbers to the same internal IP addresses and port numbers – depending on the external target address.

T

TCP

Transmission Control Protocol

Transport protocol. Session-based transmission protocol: it sets up, monitors and terminates a connection between sender and recipient for transporting data.

TLS

Transport Layer Security

Protocol for encrypting data transmissions on the Internet. TLS is a superordinate **Transport protocol**.

Transmission rate

Speed at which data is transmitted in the **WAN** or **LAN**. The transmission rate is measured in data units per unit of time (Mbit/s).

Transport protocol

Controls data transport between two communication partners (applications).

See also: **UDP, TCP, TLS**.

U

UDP

User Datagram Protocol

Transport protocol. Unlike **TCP**, **UDP** is a non session-based protocol. UDP does not establish a fixed connection. The data packets ("datagrams") are sent as a broadcast. The recipient is solely responsible for making sure the data is received. The sender is not notified about whether it is received or not.

URI

Uniform Resource Identifier

Character string for identifying resources (e.g. e-mail recipient, <http://gigaset.com>, files).

On the **Internet**, URIs are used as a uniform identification for resources. URIs are also described as SIP addresses.

URIs can be entered in the phone as a number. By dialling a URI, you can call an Internet subscriber with VoIP equipment.

URL

Universal Resource Locator

Globally unique address of a domain on the **Internet**.

A URL is a subtype of the **URI**. URIs identify a resource by its location in the **Internet**. For historical reasons, the term is often used as a synonym for URI.

User ID

See **User name**.

User name

Name/number combination for access e.g. to your VoIP account or your private address phonebook on the Internet.

V**Voice codec**

See **Codec**.

VoIP

Voice over Internet Protocol

Telephone calls are no longer placed and transmitted over the telephone network but over the **Internet** (or other IP networks).

VoIP provider

A VoIP, SIP or **Gateway provider** is an Internet service provider that provides a **Gateway** for Internet telephony. As the phone works with the SIP standard, your provider must support the SIP standard.

The provider routes calls from VoIP to the telephone network (analogue, ISDN and mobile) and vice versa.

W**WAN**

Wide Area Network

Wide-area network that is unrestricted in terms of area (e.g. **Internet**).

Accessories

Gigaset handsets

Upgrade your Gigaset to a cordless PABX:

Gigaset Handset SL930H

- ◆ Handset for upgrading Gigaset base stations to a cordless PABX
- ◆ DECT handset with Android™ and WLAN
- ◆ Android™ 4.0.4 for downloading applications from the Google Play™ Store
- ◆ Access to more than 975,000 apps
- ◆ Make calls wirelessly via the fixed line network and Internet (e.g. Skype)
- ◆ Capacitive Full Touch Display 45 x 68 mm (B x H)
- ◆ 5 freely configurable start screens
- ◆ Manage e-mail
- ◆ Load music, images and videos
- ◆ Android™ address book for up to 2000 contacts (vCards)
- ◆ Automatic synchronisation of Google contacts via WLAN
- ◆ Brilliant sound quality in duplex grade handsfree mode
- ◆ PC connection using micro USB
- ◆ Memory extension using microSD-Card up to 32GB

www.gigaset.com/gigaset/930h



Gigaset Handset SL910H

- ◆ Innovative control concept via touch display
- ◆ Handset with real metal frame
- ◆ 8.1 cm TFT colour display
- ◆ Brilliant sound quality in handsfree mode
- ◆ Bluetooth® and mini USB
- ◆ Individual menu configuration
- ◆ Directory for 500 vCards
- ◆ Talk/standby time of up to 13 hrs/180 hrs
- ◆ Brilliant sound quality in handsfree mode with 4 adjustable handsfree profiles
- ◆ Caller pictures, screensaver (analogue and digital clock)
- ◆ Download ringtone melodies
- ◆ ECO-DECT
- ◆ Alarm clock
- ◆ Calendar with appointment scheduler
- ◆ Night mode with time-controlled ringtone deactivation
- ◆ No interruptions from anonymous calls
- ◆ Baby monitor
- ◆ SMS with up to 640 characters

www.gigaset.com/gigaset/910h



Gigaset Handset S820H

- ◆ Brilliant sound quality in handsfree mode
- ◆ Illuminated keypad
- ◆ Plus/minus key for simple volume control
- ◆ 2.4" Touchscreen
- ◆ Bluetooth® and mini USB
- ◆ Directory for 500 vCards
- ◆ Talk/standby time of up to 20 hrs/250 hrs, standard batteries
- ◆ Brilliant sound quality in handsfree mode with 4 adjustable handsfree profiles
- ◆ Caller pictures, screensaver (analogue and digital clock)
- ◆ Download ringtone melodies
- ◆ ECO-DECT
- ◆ Alarm clock
- ◆ Calendar with appointment scheduler
- ◆ Night mode with time-controlled ringtone deactivation
- ◆ No interruptions from anonymous calls
- ◆ Black list for 15 unwanted numbers (depending on base station)
- ◆ Baby monitor, one touch call
- ◆ SMS with up to 640 characters



www.gigaset.com/gigaset820h

Gigaset Handset C620H

- ◆ Brilliant sound quality in handsfree mode
- ◆ 1.8" TFT colour display
- ◆ Directory for 250 entries
- ◆ Talk/standby time of up to 26 hrs/530 hrs, standard batteries
- ◆ Brilliant sound quality in handsfree mode: 4 adjustable handsfree profiles
- ◆ Screensaver (analogue and digital clock)
- ◆ ECO-DECT
- ◆ Alarm clock
- ◆ Calendar with appointment scheduler
- ◆ Night mode with time-controlled ringtone deactivation
- ◆ No interruptions from anonymous calls
- ◆ Black list for 15 unwanted numbers
- ◆ Baby monitor, one touch call
- ◆ SMS with up to 612 characters

www.gigaset.com/gigasetc620h



Gigaset Handset E630H

- ◆ Brilliant sound quality in handsfree mode
- ◆ Side keys for easy volume control
- ◆ 1.8" TFT colour display
- ◆ Splashproof
- ◆ Simple Auto Answer with any key
- ◆ Directory for 200 entries
- ◆ Talk/standby time of up to 20 hrs/250 hrs, standard batteries
- ◆ Torch function
- ◆ LED light call display
- ◆ Profile key for quick adjustment to the surroundings
- ◆ Screensaver (analogue and digital clock)
- ◆ ECO-DECT
- ◆ Alarm clock
- ◆ Calendar with appointment scheduler
- ◆ Night mode with time-controlled ringtone deactivation
- ◆ No interruptions from anonymous calls
- ◆ Baby monitor, one touch call
- ◆ SMS with up to 612 characters

www.gigaset.com/gigasete630h

Gigaset Handset C430H / C530H

- ◆ Brilliant sound quality in handsfree mode
- ◆ 1.8" TFT colour display
- ◆ Directory for 200 entries
- ◆ Talk/standby time of up to 20 hrs/250 hrs, standard batteries
- ◆ Screensaver (analogue and digital clock)
- ◆ ECO-DECT
- ◆ Alarm clock
- ◆ Calendar with appointment scheduler
- ◆ Night mode with time-controlled ringtone deactivation
- ◆ No interruptions from anonymous calls
- ◆ Baby monitor, one touch call
- ◆ SMS with up to 612 characters

www.gigaset.com/gigasetc430h

www.gigaset.com/gigasetc530h



L410 handsfree clip for cordless phones

- ◆ Complete freedom of movement when making calls
- ◆ Practical clip fastening
- ◆ Perfect sound quality in handsfree mode
- ◆ Weight approx. 30 g
- ◆ ECO-DECT
- ◆ 5 volume settings
- ◆ LED status display
- ◆ Talk/standby time of up to 5 hrs/120 hrs
- ◆ Ranges: indoors up to 50 m, outdoors up to 300 m

www.gigaset.com/gigasetl410



Gigaset repeater

You can use the Gigaset repeater to increase the reception range between your Gigaset handset and the base.

www.gigaset.com/gigasetrepeater



All accessories and batteries are available from your phone retailer.



Use only original accessories. This will avoid possible health risks and personal injury, and also ensure that all the relevant regulations are complied with.

Compatibility

You can find more information about the handset functions in connection with the individual Gigaset base stations at:

www.gigaset.com/compatibility

Mounting the base on the wall

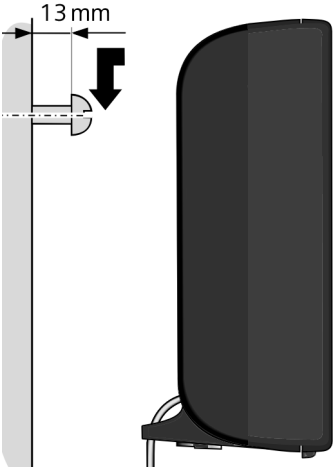
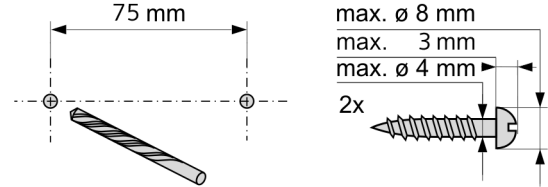

Mounting the charging cradle on the wall

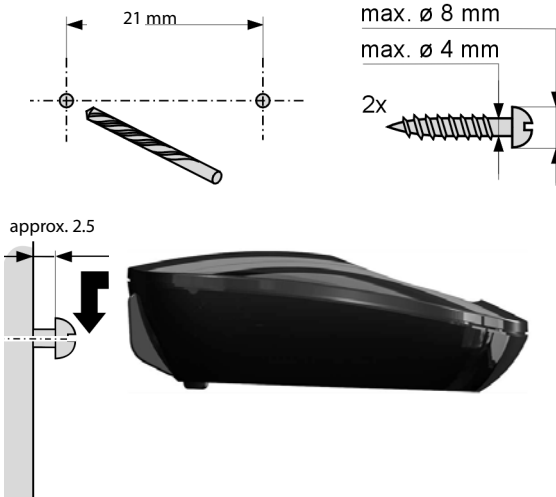

alarm.....	100
g.....	39
.....	27
.....	27
ne.....	65
ox.....	75
.....	45
hone numbers.....	38
.....	144
.....	48
.....	97
.....	48
.....	47
.....	144
ns.....	113
, enabling.....	119
sed.....	98
.....	35
ng.....	38
ick dial.....	76
r Gateway (ALG).....	144
sed.....	98
.....	97
ea code.....	52
er key.....	49
al Subscriber Line.....	144
lt clip.....	11
.....	144
.....	139
on.....	17

connect to mains power.....	
connect to telephone net.....	
connecting to PABX.....	
overview.....	
power consumption.....	
restoring to default settin.....	
setting up.....	
system PIN.....	
updating firmware.....	
Battery	
charge.....	
charging status.....	
display.....	
icon.....	
insert.....	
Beep (alert tone).....	
Best base.....	
Block dialling.....	
Broadband connections.....	
Broadband Internet access.....	
Broadband voice codec.....	
Broken display.....	
Buttons.....	
C	
Calendar.....	
Call	
accept.....	
internal.....	
transferring.....	
transferring (connecting).....	
Call costs, see Charges	
Call display	
name from online phoneb.....	
Call duration.....	

.....	52
onebook	88
ges	88
.....	92, 93
.....	80
tification	35
.....	17, 67
.....	144
.....	101
ge	44
ne	46
ers	82
nal participants	81
.....	102
e	46
.....	51
one settings	44
l	51
tings	44
tem PIN	51
.....	60, 62, 143
licator	2
the batteries	103
.....	43
.....	113
information	138
.....	144
.....	35
.....	145
.....	45
.....	145
.....	145
.....	42
rnal)	80

Consumption of electricity,	
consumption	
Contact with liquid	
Contents of the package	
Control key	
Correcting incorrect entries	
Cost control	
Costs, see Charges	
CW	

D

Data packets, fragmentation	
Deactivating	
advisory tones	
baby monitor alarm	
Call Forwarding	
handset	
keypad lock	
muting ringtone	
network mailbox	
ring delay	
withholding phone number	
Deactivating wireless module	
Delete key	
Demilitarised Zone	
De-registering	
from Web configurator	
De-registering (handset)	
Destination number (baby monitor	
alarm)	
DHCP	
Dialling	
from the call list	
IP address	
using quick dial	

..... (SMS)	63
..... n entry	87
..... /from PC	126
..... l format)	127
..... r.	126
.....	45
.....	5
..... osts.	43
..... ay language.	44
..... t.	45
.....	29
..... tments/anniversaries	98
..... line phonebook	36
..... ox message	29
..... LIP)	35
..... emory	84
.....	44
.....	44
..... tcklight	45
.....	103
.....	28
.....	49
.....	104
..... IP).	145
.....	140
.....	146
.....	146
.....	53
.....	146
..... stem.	146
..... t (SMS)	60

ECT.....
activating/deactivating
E-mail
deleting
messages whilst making a
notification
settings
viewing the sender's address
E-mail address
E-mail list
Emergency numbers
dialling plans for
not possible.
Ending
a call.
Entering special characters.
Entering special letters
Entering text
Entering umlauts.
Environment
Ethernet network
Exclusion of liability
Explicit Call Transfer
External
External call
call waiting

F

Factory settings
Fast access
Fax (SMS)
Field strength
Firewall
Firmware

.....	119
.....	148
r	148
.....	108, 109
e HDSP	
.....	36
g	39, 123
ant	92, 93
ting own name	93
.....	36
.....	93
.....	91
participants	91
.....	148
r	
munication	148
.....	80
.....	148
.....	48
nal number	82
e	81
settings	44
different base	79
est reception	79
.....	45
the handset	78, 79
ght	45
ge	44
ne	46
.....	29
.....	2
.....	27

connecting (wire-bound)	
Headset socket	
Hearing	
prevent loss of	
Hearing aids	
Help	
High Definition Sound Perfo	
HDSP	
Hold music	
HTTP Proxy	
Hub	
I	
Icon	
alarm clock	
keypad lock	
new SMS	
ringtone	
Icons	
displaying new messages	
on display keys	
status bar	
Idle status	
returning to	
Idle status (display)	
IEEE	
Incoming message list	
opening (e-mail)	
Incoming message list (SMS)	
Incorrect entries (correction)	
Info Centre	
operating	
Infrastructure network	
Input fields	

Local SIM port.....	149
broadband).....	144
on.....	13
.....	149
Provider.....	149
.....	149
.....	149
.....	52
.....	32
dset.....	3
.....	146
.....	147
.....	148
.....	149
omatically.....	52
.....	151
.....	152
.....	153
.....	52
.....	149
).....	76
.....	27
.....	49
.....	2
.....	27
.....	28
.....	28
se).....	3
.....	149
.....	14

Lock	
activating/deactivating ke	
Loss of hearing.....	
Lower/upper case.....	
M	
MAC address.....	
checking.....	
Mains power supply.....	
Making calls	
accepting a call.....	
external.....	
internal.....	
Making cost-effective calls.....	
Marked characters.....	
Maximum Receive Unit.....	
Maximum Transmission Unit.....	
Mbps.....	
Media Access Control.....	
Medical equipment.....	
Melody	
ringtone for internal/exte	
Memory in the phonebook.....	
Menu	
opening.....	
using.....	
Web configurator overview	
Menu bar.....	
Message	
deleting (e-mail).....	
playing back (network ma	
Message Key	
opening list.....	
Message list.....	

VoIP).....	145	switching to tone dialling
from online phonebook..	36	Paging
.....	81	Paging key.....
.....	150	Pause
.....	154	after access code.....
.....	113	after line seizure
.....	91	after Recall key
.....	150	PC address book entries
.....	147	copying to the phoneb
Translation	150	PD (pulse dialling).....
.....	75	Personal Identification Num
Private	75	Phone
.....	76, 77	setting
Quick dial	76	Phone number display, note
per.....	75	Phone number display, with
.....	77	Phonebook
Network mailbox		copying number from tex
.....	38	opening.....
.....		sending entry/list to hand
.....	67	sending to handset.....
.....		using to enter numbers .
for baby monitor alarm.	100	PIN
SMS.....	63	Pin connections.....
phonebook.....	86	Port
er's number (CLIP)	35	Port forwarding.....
per of network mailbox ..	75	Port number
the phonebook	86	Power adapter.....
er in the phonebook.....	84	Power consumption (base).
withholding	38	Pre-dialling
.....	30	Preferred DNS server.....
.....		Private IP address
.....		Protocol.....
.....		Proxy
.....		Proxy-Server

.....	127
.....	102
ations	
.....	64
er, see Repeater	
.....	32
on	96
mission power	96
.....	78
igurator	110
.....	152
.....	58
signalling)	123
.....	45
s not answered	152
ber is busy	152
.....	46
.....	46
ernal/external calls.	47
.....	65
.....	47
.....	152
.....	152
.....	153
.....	153
.....	153
de)	101
.....	7
.....	44
.....	84

Setting up	
base station.....	
charging cradle.....	
handset.....	
Setting up the telephone	
for use.....	
Signal tone, see Advisory tone	
Silence, suppressing.....	
Simple Transversal of UDP over	
SIP.....	
SIP address.....	
SIP port.....	
SIP provider.....	
SIP proxy server.....	
SMS.....	
deleting.....	
draft message list.....	
forwarding.....	
incoming list.....	
notification via SMS.....	
reading.....	
receiving.....	
replying to or forwarding	
saving number.....	
self help with error messages	
send centre.....	
sending as fax.....	
sending to e-mail address	
status report.....	
troubleshooting.....	
vCard.....	
writing.....	
SMS centre	
changing number.....	
setting.....	

.....	154
.....	51
.....	154
.....	141
.....	9
.....	140
oin connections	142
ork	12
e SMS	
t conference	42
.....	47
.....	154
.....	101, 102
ontrol Protocol	154
e.....	154
ecurity	154
ol.....	154
.....	68
.....	131
.....	66
.....	154
e Identifier	154
ce Locator	154
.....	35
e.....	30
.....	154
.....	154

configuring account (first)	
loading provider data	...
status codes (table)
VoIP provider
downloading data
selecting
VoIP status messages	
status codes table
VoIP user data	
entering (connection wizard)	
Volume	
earpiece
handset speaker volume	
speaker

W

WAN
Warning tone, see Advisory tone	
Weather forecast, in idle display	
Web configurator	
connecting with PC
de-registering
DTMF signalling for VoIP	
interface language
menu
Web page	
structure
Wide Area Network
Withheld number
Withholding	
phone number display	..
suppressing speech pause	
Working area
Writing (SMS)

M

Issued by
Gigaset Communications GmbH
Frankenstr. 2a, D-46395 Bocholt

© Gigaset Communications GmbH 2014
Subject to availability.
All rights reserved. **Rights of modification reserved.**
www.gigaset.com

This user guide is made from 100% recycled paper.